

Noise Figure Measurement Personality Guide

Agilent Technologies ESA-E Series Spectrum Analyzers Option 219

This manual provides documentation for the following instruments:

ESA-E Series

E4401B (9 kHz - 1.5 GHz)

E4402B (9 kHz - 3.0 GHz)

E4404B (9 kHz - 6.7 GHz)

E4405B (9 kHz - 13.2 GHz)

E4407B (9 kHz - 26.5 GHz)



Agilent Technologies

Manufacturing Part Number: E4401-90514

Supersedes E4440-90239

Printed in USA

December 2006

© Copyright 2002 - 2006 Agilent Technologies, Inc.

Notice

The information contained in this document is subject to change without notice.

Agilent Technologies makes no warranty of any kind with regard to this material, including but not limited to, the implied warranties of merchantability and fitness for a particular purpose. Agilent Technologies shall not be liable for errors contained herein or for incidental or consequential damages in connection with the furnishing, performance, or use of this material.

Where to Find the Latest Information

Documentation is updated periodically. For the latest information about Agilent ESA Spectrum Analyzers, including firmware upgrades, software upgrades, application information, and product information, please visit the Internet URL listed below.

<http://www.agilent.com/find/esa>

Getting Started

What You will Find in this Chapter	24
Introduction	25
Installing the Noise Figure Personality	26
Available Measurement Personality Options	27
Installing an Optional Measurement Personality	28
Installing a License Key	30
Starting the Noise Figure Personality	31
Saving the Instrument State	32
Keeping Your Measurement Data and Instrument Setups Secure	33

Making Basic Measurements

What You will Find in this Chapter	36
Entering Excess Noise Ratio (ENR) Data	37
Selecting a Common ENR Table	37
Entering ENR Table Data for Noise Sources	38
Saving an ENR Table	43
Entering a Spot ENR Value	44
Entering a Spot Thot Value	45
Setting the Tcold value	46
Setting the Measurement Frequencies	48
Using Sweep Frequency Mode	48
Using List Frequency Mode	49
Using Fixed Frequency Mode	52
Setting the Bandwidth and Averaging	53
Effect of Bandwidth and Averaging on Speed, Jitter, and Measurement Accuracy ..	53
Selecting the Resolution Bandwidth Value	53
Setting Averaging	55
Calibrating the Analyzer	56
To perform a calibration	58
Selecting the Input Attenuation Range	60
Displaying the Measurement Results	63
Selecting the Display Format	63
Selecting Result Types to Display	65
Graphical Features	66
Setting the Scaling	70
Working with Markers	72
Indicating an Invalid Result	79
Example of a Basic Amplifier Measurement	80
Calibrating the Noise Figure Analyzer	81
Making Measurements	84
Further Information on Noise Figure Measurements	86

Advanced Features

Contents

What You will Find in this Chapter	88
Setting up Limit Lines	89
Creating a Limit Line	91
Using Loss Compensation	94
Examples where Loss Compensation is applied	94
Configuring Fixed Loss Compensation	94
Configuring Table Loss Compensation	97
Setting Temperature of Loss	101
Adjusting the Preselector	103
How to Manually Center the Preselector Filter to Optimize Noise Figure Measurements	104
Noise Figure Uncertainty Calculator	106
Example Calculation:	107
Making Frequency Converter Measurements	
What You will Find in this Chapter	110
Overview of Frequency Converter Measurements	111
DUT Types	113
Basic Measurement — No Frequency Conversion	114
Frequency Downconverting DUT	115
Frequency Upconverting DUT	118
System Downconverter	121
Comparison of the 8970B, the NFA analyzer and the Option 219 Noise Figure Measurement Application	124
Choosing and Setting Up the Local Oscillator	125
Selecting a Local Oscillator for Extended Frequency measurements with Option 219	125
Selecting a Local Oscillator for Option 219	126
Connecting the System	127
Setting Up the Noise Figure Analyzer	127
Measuring a Frequency Converting DUT	129
Sidebands and Images	132
Signal Leakage	133
LO Leakage	133
LO Harmonics	134
Single Sideband Measurements	135
Double Sideband Measurements	137
Fixed LO	140
Making Frequency Converting DUT Measurements	141
Making Downconverting DUT Measurements using a Fixed LO and Fixed IF (Equivalent to Mode 1.4 on an 8970B Noise Figure Analyzer)	142
Making Upconverting DUT Measurements using a Fixed LO and Variable IF (Equivalent to Mode 1.4 with SUM on an 8970B Noise Figure Meter)	148
Measurements with a System Downconverter	149

Contents

USB, LSB or DSB?	150
Measurement Modes with a DSB System Downconverter.....	150
Measurement Modes with an SSB System Downconverter.....	152
FIXED LO, LSB	154
FIXED LO, USB	155
Frequency Restrictions	156
Glossary of Restricted Terms	156
General Restrictions.....	157
Frequency Downconverting DUT.....	158
Frequency Upconverting DUT.....	159
System Downconverter.....	160

Menu Maps

What You Will Find in This Chapter	162
Key to this chapter's menumap diagrams.....	162
Menus	163
Amplitude Menu - Monitor Spectrum Measurement	163
Amplitude Menu - Noise Figure Measurement.....	164
BW/Avg Menu - Monitor Spectrum Measurement	165
BW/Avg Menu - Noise Figure Measurement.....	166
Det/Demod Menu - Monitor Spectrum Measurement	167
Det/Demod Menu - Noise Figure Measurement	168
Display Menus - Monitor Spectrum Measurement.....	169
Display Menus - Noise Figure Measurement	170
File Type Menu - Monitor Spectrum Measurement	171
File Type Menu - Noise Figure Measurement (ESA only)	172
File Type Menu - Noise Figure Measurement (PSA only)	173
Frequency Menu - Monitor Spectrum Measurement	174
Frequency Menu - Noise Figure Measurement.....	175
Input Output Menu - Monitor Spectrum Measurement.....	176
Input Output Menu - Noise Figure Measurement	177
Marker Menu - Monitor Spectrum Measurement.....	178
Marker Menu - Noise Figure Measurement	179
Meas Setup Menu - Monitor Spectrum Measurement	180
Meas Setup Menu - Noise Figure Measurement.....	181
Measure Menu	182
Mode Menu	183
Mode Setup Menu.....	184
Mode Setup - DUT Setup Menu.....	185

Contents

Source Menu - Noise Figure Measurement	186
Span Menu - Monitor Spectrum Measurement	187
Span Menu - Noise Figure Measurement	188
Sweep Menu - Monitor Spectrum Measurement	189
Sweep Menu - Noise Figure Measurement	190
View/Trace Menu - Monitor Spectrum Measurement	191
View/Trace Menu - Noise Figure Measurement	192
Uncertainty Calculator Menus	193
Front-Panel Key Reference	
Key Descriptions and Locations	196
AMPLITUDE Y Scale	197
BW/Avg.	199
Det/Demod	201
Display	203
FREQUENCY Channel	207
Input/Output	210
Marker	213
Peak Search	215
Meas Setup.	217
MEASURE	223
MODE.	224
Mode Setup	225
Mode Setup — DUT Setup	226
Mode Setup - Uncertainty Calculator.	228
Preset	231
Source	232
SPAN X Scale	233
Sweep Menu.	234
View/Trace	235
Language Reference	
CALCulate Subsystem	240
Test Current Results Against all Limits	240
Noise Figure Measurement	241
CONFigure Subsystem	252
Configure the Selected Measurement.	252
Configure Query	252
DISPlay Subsystem.	253
Full Screen Display	253
Set the Display Line Level.	253
Set the Display Line State	254
Set the Y-Axis Scale per Division	254
Set the Reference Level	254

Contents

Set Display Annotation On/Off	255
Date and Time Display	255
Date and Time Display	255
Noise Figure Corrections	256
Select Results for Display (A)	256
Select Results for Display (B)	257
Select Results Format	258
Set Graticule On or Off	258
Set Graph View	258
Noise Figure - Set the Y-Axis Scale per Division	259
Noise Figure - Set the Y-Axis Reference Value	260
Noise Figure - Set the Y-Axis Reference Position	261
Zoom Window	262
FETCh Subsystem	263
Fetch the Current Measurement Results	263
FORMat Subsystem	264
Byte Order	264
Numeric Data Format	264
INITiate Subsystem	267
Take New Data Acquisition for Selected Measurement	267
Continuous or Single Measurements	267
Take New Data Acquisitions	268
Pause the Measurement	269
Restart the Measurement	270
Resume the Measurement	270
INPut Subsystem	271
RF Attenuation Setting	271
Maximum Microwave Attenuation Setting	271
Minimum Microwave Attenuation Setting	271
Maximum RF Attenuation Setting	272
Minimum RF Attenuation Setting	272
RF Input Port Coupling	273
INSTRument Subsystem	274
Select Application by Number	274
Select Application	274
MEASure Group of Commands	276
Command Interactions: MEASure, CONFigure, FETCh, INITiate and READ . . .	276
Monitor Spectrum	280

Contents

Noise Figure Measurement	281
Noise Figure Measurement - Gain Results	282
Noise Figure Measurement - Noise Factor Results	283
Noise Figure Measurement - Noise Figure Results	284
Noise Figure Measurement - Cold Power Pcold Density Results	285
Noise Figure Measurement - Hot Power Phot Density Results	286
Noise Figure Measurement - Effective Temperature Results	287
Noise Figure Measurement - Tcold Results	288
Noise Figure Measurement - Y Factor Results	289
MMEMory Subsystem	290
Load a Noise Figure ENR Table from a File	290
Load a Noise Figure Frequency List Table from a File	290
Load a Limit Line from Memory to the Instrument	291
Load a Noise Figure Loss Compensation Table from a File	291
Store a Noise Figure ENR Table to a File	291
Store a Limit Line in a File	291
Store a Noise Figure Frequency List Table to a File	292
Store a Noise Figure Loss Compensation Table to a File	292
Store a Measurement Results in a File	292
Store a Trace in a File	293
OUTPut Subsystem	294
Turn Noise Source On/Off	294
READ Subsystem	295
Initiate and Read Measurement Data	295
SENSE Subsystem	296
Bandwidth Commands	297
Configure Commands	299
Default Reset	305
Monitor Spectrum or Monitor Band/Channel Measurement	306
Noise Figure Measurement	316
RF Power Commands	340
SOURce Subsystem	341
Noise Source State	341
SNS Attached?	341
Noise Source Preference	341
TRACe Subsystem	343
Query Trace Maximum Amplitude	343
Query Trace Minimum Amplitude	344
Query Trace Amplitude	344
Query Trace Delta	345
Query Trace Peak to Peak	346

Troubleshooting Guide

Contents

Common Problems and their Resolution	348
Problems Measuring Above 3 GHz	352
Contacting Agilent Technologies	
Contacting Agilent	356

Contents

List of Commands

:CALCulate:CLIMits:FAIL?	240
:CALCulate:UNCertainty:DUT:GAIN <value>	246
:CALCulate:UNCertainty:DUT:GAIN?	246
:CALCulate:UNCertainty:DUT:MATCH:INPut <value>	246
:CALCulate:UNCertainty:DUT:MATCH:INPut?	246
:CALCulate:UNCertainty:DUT:MATCH:OUTPut <value>	247
:CALCulate:UNCertainty:DUT:MATCH:OUTPut?	247
:CALCulate:UNCertainty:DUT:NFIGure <value>	247
:CALCulate:UNCertainty:DUT:NFIGure?	247
:CALCulate:UNCertainty:INSTRument:GAIN <value>	247
:CALCulate:UNCertainty:INSTRument:GAIN?	247
:CALCulate:UNCertainty:INSTRument:MATCH <value>	248
:CALCulate:UNCertainty:INSTRument:MATCH?	248
:CALCulate:UNCertainty:INSTRument:NFIGure <value>	248
:CALCulate:UNCertainty:INSTRument:NFIGure:UNCertainty <value>	248
:CALCulate:UNCertainty:INSTRument:NFIGure:UNCertainty?	248
:CALCulate:UNCertainty:INSTRument:NFIGure?	248
:CALCulate:UNCertainty:RSS?	249
:CALCulate:UNCertainty:SOURce:ENR <value>	249
:CALCulate:UNCertainty:SOURce:ENR?	249
:CALCulate:UNCertainty:SOURce:MATCH <value>	249
:CALCulate:UNCertainty:SOURce:MATCH?	250
:CALCulate:UNCertainty:SOURce:TYPE <value>	251
:CALCulate:UNCertainty:SOURce:TYPE?	251
:CALCulate[:NFIGure]:LLINe[1] 2 3 4:COUNT?	241
:CALCulate[:NFIGure]:LLINe[1] 2 3 4:DISPlay[:STATe] OFF ON 0 1	242
:CALCulate[:NFIGure]:LLINe[1] 2 3 4:DISPlay[:STATe]?	242
:CALCulate[:NFIGure]:LLINe[1] 2 3 4:TEST[:STATe] OFF ON 0 1	242
:CALCulate[:NFIGure]:LLINe[1] 2 3 4:TEST[:STATe]?	242
:CALCulate[:NFIGure]:LLINe[1] 2 3 4:TYPE UPPer LOWer	243
:CALCulate[:NFIGure]:LLINe[1] 2 3 4:TYPE?	243

List of Commands

:CALCulate[:NFIGure]:LLINe[1] 2 3 4[:DATA] <frequency>,<amplitude>,<connected>[<frequency>,<amplitude>,<connected>].	241
:CALCulate[:NFIGure]:LLINe[1] 2 3 4[:DATA]?	241
:CALCulate[:NFIGure]:LLINe[1] 2 3 4[:STATe] OFF ON 0 1	242
:CALCulate[:NFIGure]:LLINe[1] 2 3 4[:STATe]?	242
:CALCulate[:NFIGure]:MARKer[1] 2 3 4[:STATe] OFF ON 0 1	245
:CALCulate[:NFIGure]:MARKer[1] 2 3 4[:STATe]?	245
:CALCulate[:NFIGure]:MARKer[1] 2 3 4:BPAir:MODE NORMAl:REFerence.	243
:CALCulate[:NFIGure]:MARKer[1] 2 3 4:BPAir:MODE?	243
:CALCulate[:NFIGure]:MARKer[1] 2 3 4:MODE POSition DELTA BPAir.	243
:CALCulate[:NFIGure]:MARKer[1] 2 3 4:MODE?	243
:CALCulate[:NFIGure]:MARKer[1] 2 3 4:SEArch:CONTInuous OFF ON 0 1	244
:CALCulate[:NFIGure]:MARKer[1] 2 3 4:SEArch:CONTInuous?	244
:CALCulate[:NFIGure]:MARKer[1] 2 3 4:SEArch:TYPE MAXimum MINimum PEAK	244
:CALCulate[:NFIGure]:MARKer[1] 2 3 4:SEArch:TYPE?	244
:CALCulate[:NFIGure]:MARKer[1] 2 3 4:X <freq>	245
:CALCulate[:NFIGure]:MARKer[1] 2 3 4:X?	245
:CALCulate[:NFIGure]:MARKer[1] 2 3 4:Y?	246
:CONFigure:<measurement>	252
:CONFigure:MONitor	280
:CONFigure?	252
:CONFigure[:NFIGure]	281
:DISPlay[:NFIGure]:ZOOM:WINDow OFF UPPer LOWer	262
:DISPlay[:NFIGure]:ZOOM:WINDow?	262
:DISPlay:FSCREEN[:STATe] OFF ON 0 1	253
:DISPlay:FSCREEN[:STATe]?	253
:DISPlay:FSCREEN FULLSCREEN[:STATe] ON OFF 1 0	253
:DISPlay:FSCREEN FULLSCREEN[:STATe]?	253
:DISPlay:MONitor:WINDow:TRACe:Y:DLINe <power>	253
:DISPlay:MONitor:WINDow:TRACe:Y:DLINe:STATe ON OFF 1 0	254
:DISPlay:MONitor:WINDow:TRACe:Y:DLINe:STATe?	254

List of Commands

:DISPlay:MONitor:WINDow:TRACe:Y:DLINe?	253
:DISPlay:MONitor:WINDow:TRACe:Y[:SCALe]:PDIVision <dB>	254
:DISPlay:MONitor:WINDow:TRACe:Y[:SCALe]:PDIVision?	254
:DISPlay:MONitor:WINDow:TRACe:Y[:SCALe]:RLEVel <dB>	254
:DISPlay:MONitor:WINDow:TRACe:Y[:SCALe]:RLEVel?	254
:DISPlay[:NFIGure]:ANNotation:CLOCK:DATE:FORMat MDY DMY	255
:DISPlay[:NFIGure]:ANNotation:CLOCK:DATE:FORMat?	255
:DISPlay[:NFIGure]:ANNotation:CLOCK[:STATe] OFF ON 0 1	255
:DISPlay[:NFIGure]:ANNotation:CLOCK[:STATe]?	255
:DISPlay[:NFIGure]:ANNotation[:STATe] ON OFF 1 0	255
:DISPlay[:NFIGure]:ANNotation[:STATe]?	255
:DISPlay[:NFIGure]:DATA:CORRections[:STATe] ON OFF 1 0	256
:DISPlay[:NFIGure]:DATA:CORRections[:STATe]?	256
:DISPlay[:NFIGure]:DATA:FORMat GRAPH TABLE METER	258
:DISPlay[:NFIGure]:DATA:FORMat?	258
:DISPlay[:NFIGure]:DATA:TRACe[1] NFIGure NFACTor GAIN YFACTor TEFFec- tive PHOT PCOLD	256
:DISPlay[:NFIGure]:DATA:TRACe[1]?	256
:DISPlay[:NFIGure]:DATA:TRACe[1]?	257
:DISPlay[:NFIGure]:DATA:TRACe2 NFIGure NFACTor GAIN YFACTor TEFFec- tive PHOT PCOLD	257
:DISPlay[:NFIGure]:GRATICule[:STATe] ON OFF 1 0	258
:DISPlay[:NFIGure]:GRATICule[:STATe]?	258
:DISPlay[:NFIGure]:TRACe:COMBined[:STATe] ON OFF 1 0	258
:DISPlay[:NFIGure]:TRACe:COMBined[:STATe]?	258
:DISPlay[:NFIGure]:TRACe:Y[:SCALe]:PDIVision <result>, <value>	259
:DISPlay[:NFIGure]:TRACe:Y[:SCALe]:PDIVision?	259
:DISPlay[:NFIGure]:TRACe:Y[:SCALe]:RLEVel:VALue <result>, <value>	260
:DISPlay[:NFIGure]:TRACe:Y[:SCALe]:RLEVel:VALue?	260
:DISPlay[:NFIGure]:TRACe:Y[:SCALe]:RPOSition <result>, <value>	261
:DISPlay[:NFIGure]:TRACe:Y[:SCALe]:RPOSition?	261
:FETCh:<measurement>[n]?	263

List of Commands

:FETCh:MONitor[n].	280
:FETCh[:NFIGure]([:ARRay] :SCALar)[:DATA](:CORRected :UNCorrected):NFACTor?	283
:FETCh[:NFIGure]([:ARRay] :SCALar)[:DATA](:CORRected :UNCorrected):NFIGure?	284
:FETCh[:NFIGure]([:ARRay] :SCALar)[:DATA](:CORRected :UNCorrected):PCOLd?	285
:FETCh[:NFIGure]([:ARRay] :SCALar)[:DATA](:CORRected :UNCorrected):PHOT?	286
:FETCh[:NFIGure]([:ARRay] :SCALar)[:DATA](:CORRected :UNCorrected):TEFFective?	287
:FETCh[:NFIGure]([:ARRay] :SCALar)[:DATA]:CORRected:GAIN?	282
:FETCh[:NFIGure]([:ARRay] :SCALar)[:DATA]:TCOLd?	288
:FETCh[:NFIGure]([:ARRay] :SCALar)[:DATA]:UNCorrected :YFACTor?	289
:FETCh[:NFIGure]?	281
:FORMat:BORDer NORMal SWAPped	264
:FORMat:BORDer?	264
:FORMat[:TRACe][:DATA] ASCii REAL[,32]	264
:FORMat[:TRACe][:DATA]?	264
:INITiate:<measurement>	267
:INITiate:CONTInuous OFF ON 0 1	267
:INITiate:CONTInuous?	267
:INITiate:PAUse	269
:INITiate:REStart	270
:INITiate:RESume	270
:INITiate[:IMMEdiate]	268
:INITiate[:NFIGure].	281
:INPut:COUPling AC DC	273
:INPut:COUPling? AC DC	273
:INPut[:NFIGure]:ATTenuation <power>	271
:INPut[:NFIGure]:ATTenuation	271
:INPut[:NFIGure]:ATTenuation:MWAVE:MAXimum <integer>	271
:INPut[:NFIGure]:ATTenuation:MWAVE:MAXimum	271
:INPut[:NFIGure]:ATTenuation:MWAVE:MINimum <integer>	271
:INPut[:NFIGure]:ATTenuation:MWAVE:MINimum	271
:INPut[:NFIGure]:ATTenuation[:RF]:MAXimum <integer>	271

List of Commands

:INPut[:NFIGure]:ATTenuation[:RF]:MAXimum <integer>	272
:INPut[:NFIGure]:ATTenuation[:RF]:MAXimum	272
:INPut[:NFIGure]:ATTenuation[:RF]:MINimum <integer>.	272
:INPut[:NFIGure]:ATTenuation[:RF]:MINimum <integer>.	272
:INPut[:NFIGure]:ATTenuation[:RF]:MINimum	272
:INSTRument:NSElect <integer>	274
:INSTRument:NSElect?	274
:INSTRument[:SElect] 'SA' 'GSM' 'CDMA' 'PNOISE' 'BLUETOOTH' 'MAN' 'LINK' 'CATV' 'NFIGURE'.	274
:INSTRument[:SElect]?	275
:MEASure:MONitor[n]	280
:MEASure[:NFIGure]([:ARRay] :SCALar)[:DATA]([:CORReCted :UNCORReCted):NFACTor?	283
:MEASure[:NFIGure]([:ARRay] :SCALar)[:DATA]([:CORReCted :UNCORReCted):NFIGure?	284
:MEASure[:NFIGure]([:ARRay] :SCALar)[:DATA]([:CORReCted :UNCORReCted):PCOLd?	285
:MEASure[:NFIGure]([:ARRay] :SCALar)[:DATA]([:CORReCted :UNCORReCted):PHOT?	286
:MEASure[:NFIGure]([:ARRay] :SCALar)[:DATA]([:CORReCted :UNCORReCted):TEFFective?	287
:MEASure[:NFIGure]([:ARRay] :SCALar)[:DATA]:CORReCted:GAIN?	282
:MEASure[:NFIGure]([:ARRay] :SCALar)[:DATA]:TCOLd?	288
:MEASure[:NFIGure]([:ARRay] :SCALar)[:DATA]:UNCORReCted :YFACTor?	289
:MEASure[:NFIGure]?	281
:MMEMory:LOAD:ENR CALibration MEASurement, <file_name>	290
:MMEMory:LOAD:LIMit LLINE1 LLINE2 LLINE3 LLINE4, <file_name>.	291
:MMEMory:LOAD:LOSS BEFore AFTer, <file_name>	291
:MMEMory:STORe:ENR CALibration MEASurement, <file_name>.	291
:MMEMory:STORe:LIMit LLINE1 LLINE2, <file_name>	291
:MMEMory:STORe:LIMit LLINE1 LLINE2 LLINE3 LLINE4, <file_name>	291
:MMEMory:STORe:LOSS BEFore AFTer, <file_name>	292
:MMEMory:STORe:RESults filename.csv.	292
:MMEMory:STORe:TRACe TRACe1 TRACe2 ALL, <file_name>	293
:MMEMory:STORe:TRACe TRACe1 TRACe2 TRACE3 ALL, <file_name>	293
:MMEMory[:NFIGure]:LOAD:FREQUency, <file_name>.	290

List of Commands

:MMEMory[:NFIGure]:STORE:FREQuency, <file_name>	292
:OUTPut:MONitor:NOISe[:STATe] OFF ON 0 1	294
:OUTPut:MONitor:NOISe[:STATe]?	294
:READ:<measurement>[n]?	295
:READ:MONitor[n]	280
:READ[:NFIGure]([:ARRay] :SCALar)[:DATA](:CORReCted :UNCORReCted):NFACTOR?	283
:READ[:NFIGure]([:ARRay] :SCALar)[:DATA](:CORReCted :UNCORReCted):NFIGure?	284
:READ[:NFIGure]([:ARRay] :SCALar)[:DATA](:CORReCted :UNCORReCted):PCOLd?	285
:READ[:NFIGure]([:ARRay] :SCALar)[:DATA](:CORReCted :UNCORReCted):PHOT?	286
:READ[:NFIGure]([:ARRay] :SCALar)[:DATA](:CORReCted :UNCORReCted):TEFFective?	287
:READ[:NFIGure]([:ARRay] :SCALar)[:DATA]:CORReCted:GAIN?	282
:READ[:NFIGure]([:ARRay] :SCALar)[:DATA]:TCOLd?	288
:READ[:NFIGure]([:ARRay] :SCALar)[:DATA]:UNCORReCted :YFACTOR?	289
:READ[:NFIGure]?	281
:SENSe:NFIGure:MANual:RF :MWAVE:FIXed <power>	271
:SOURce:MONitor:NOISe[:STATe] ON OFF 1 0	341
:SOURce:MONitor:NOISe[:STATe]?	341
:SOURce:NOISe:SNS:ATTached?	341
:SOURce[:NFIGure]:NOISe[:PREFereNce] NORMAL SNS	341
:SOURce[:NFIGure]:NOISe[:PREFereNce]?	341
:TRACe[:NFIGure][[:DATA]:CORReCted :UNCORReCted]:AMPLitude :MAXimum? <trace>	343
:TRACe[:NFIGure][[:DATA]:CORReCted :UNCORReCted]:AMPLitude [:VALue]? <trace>,<freq>	344
:TRACe[:NFIGure][[:DATA]:CORReCted :UNCORReCted]:AMPLitude:MINimum? <trace>	344
:TRACe[:NFIGure][[:DATA]:CORReCted :UNCORReCted]:DELTA? <trace>,<freq1>,<freq2>	345
:TRACe[:NFIGure][[:DATA]:CORReCted :UNCORReCted]:PTPeak? <trace>	346
[:SENSe]:CONFigure:MODE:DOWNconv:FREQuency:CONText RF IF	299
[:SENSe]:CONFigure:MODE:DOWNconv:FREQuency:CONText?	299
[:SENSe]:CONFigure:MODE:DOWNconv:LOSCillator:FREQuency <value>	299
[:SENSe]:CONFigure:MODE:DOWNconv:LOSCillator:FREQuency?	299
[:SENSe]:CONFigure:MODE:DOWNconv:LOSCillator:OFFSet LSB USB DSB	300
[:SENSe]:CONFigure:MODE:DOWNconv:LOSCillator:OFFSet?	300

List of Commands

[[:SENSe]:CONFigure:MODE:DUT AMPLifier DOWNconv UPConv	300
[[:SENSe]:CONFigure:MODE:DUT?	300
[[:SENSe]:CONFigure:MODE:SYSTem:DOWNconv[:STATe] ON OFF 1 0	301
[[:SENSe]:CONFigure:MODE:SYSTem:DOWNconv[:STATe]?	301
[[:SENSe]:CONFigure:MODE:SYSTem:FREQuency:CONText RF IF	302
[[:SENSe]:CONFigure:MODE:SYSTem:FREQuency:CONText?.	302
[[:SENSe]:CONFigure:MODE:SYSTem:LOSCillator:FREQuency <value>	301
[[:SENSe]:CONFigure:MODE:SYSTem:LOSCillator:FREQuency?	301
[[:SENSe]:CONFigure:MODE:SYSTem:LOSCillator:OFFSet LSB USB DSB.	302
[[:SENSe]:CONFigure:MODE:SYSTem:LOSCillator:OFFSet?	302
[[:SENSe]:CONFigure:MODE:UPConv:FREQuency:CONText RF IF.	303
[[:SENSe]:CONFigure:MODE:UPConv:FREQuency:CONText?.	303
[[:SENSe]:CONFigure:MODE:UPConv:LOSCillator:FREQuency <value>	303
[[:SENSe]:CONFigure:MODE:UPConv:LOSCillator:FREQuency?	303
[[:SENSe]:CONFigure:MODE:UPConv:LOSCillator:OFFSet LSB USB.	304
[[:SENSe]:CONFigure:MODE:UPConv:LOSCillator:OFFSet?	304
[[:SENSe]:DEFaults	305
[[:SENSe]:MONitor:AVERage:COUNT <integer>	306
[[:SENSe]:MONitor:AVERage:COUNT?	306
[[:SENSe]:MONitor:AVERage:TCONtrol EXPonential REPeat.	307
[[:SENSe]:MONitor:AVERage:TCONtrol?	307
[[:SENSe]:MONitor:AVERage[:STATe] OFF ON 0 1	306
[[:SENSe]:MONitor:AVERage[:STATe]?	306
[[:SENSe]:MONitor:BANDwidth BWIDth:VIDeo <freq>.	297
[[:SENSe]:MONitor:BANDwidth BWIDth:VIDeo <freq>.	308
[[:SENSe]:MONitor:BANDwidth BWIDth:VIDeo:AUTO OFF ON 0 1	297
[[:SENSe]:MONitor:BANDwidth BWIDth:VIDeo:AUTO OFF ON 0 1	308
[[:SENSe]:MONitor:BANDwidth BWIDth:VIDeo:AUTO?	297
[[:SENSe]:MONitor:BANDwidth BWIDth:VIDeo:AUTO?	308
[[:SENSe]:MONitor:BANDwidth BWIDth:VIDeo:RATio <numeric>.	298
[[:SENSe]:MONitor:BANDwidth BWIDth:VIDeo:RATio <numeric>.	309

List of Commands

[:SENSe]:MONitor:BANDwidth BWIDth:VIDeo:RATio?	298
[:SENSe]:MONitor:BANDwidth BWIDth:VIDeo:RATio?	309
[:SENSe]:MONitor:BANDwidth BWIDth:VIDeo?	297
[:SENSe]:MONitor:BANDwidth BWIDth:VIDeo?	308
[:SENSe]:MONitor:BANDwidth BWIDth[:RESolution] <freq>	297
[:SENSe]:MONitor:BANDwidth BWIDth[:RESolution] <freq>	307
[:SENSe]:MONitor:BANDwidth BWIDth[:RESolution]:AUTO OFF ON 0 1	307
[:SENSe]:MONitor:BANDwidth BWIDth[:RESolution]:AUTO?	308
[:SENSe]:MONitor:BANDwidth BWIDth[:RESolution]?	297
[:SENSe]:MONitor:BANDwidth BWIDth[:RESolution]?	307
[:SENSe]:MONitor:DETEctor[:FUNction] NORMal POSitive NEGative AVERage	309
[:SENSe]:MONitor:DETEctor[:FUNction]?	309
[:SENSe]:MONitor:FREQuency:OFFSet <freq>	310
[:SENSe]:MONitor:FREQuency:OFFSet:AUTO ON OFF 1 0	310
[:SENSe]:MONitor:FREQuency:OFFSet:AUTO?	310
[:SENSe]:MONitor:FREQuency:OFFSet?	310
[:SENSe]:MONitor:FREQuency:SPAN <freq>	311
[:SENSe]:MONitor:FREQuency:SPAN:FULL	312
[:SENSe]:MONitor:FREQuency:SPAN:ZERO	312
[:SENSe]:MONitor:FREQuency:SPAN?	311
[:SENSe]:MONitor:FREQuency:STARt <freq>	312
[:SENSe]:MONitor:FREQuency:STARt?	312
[:SENSe]:MONitor:FREQuency:STOP <freq>	313
[:SENSe]:MONitor:FREQuency:STOP?	313
[:SENSe]:MONitor:FREQuency[:CENTer] <freq>	309
[:SENSe]:MONitor:FREQuency[:CENTer]?	309
[:SENSe]:MONitor:POWer[:RF]:ATTenuation <rel_power>	313
[:SENSe]:MONitor:POWer[:RF]:ATTenuation:AUTO ON OFF 1 0	314
[:SENSe]:MONitor:POWer[:RF]:ATTenuation:AUTO?	314
[:SENSe]:MONitor:POWer[:RF]:ATTenuation?	313
[:SENSe]:MONitor:POWer[:RF]:GAIN[:STATe]?	314

List of Commands

[[:SENSe]:MONitor:POWer[:RF]:GAIN[:STATe] ON OFF 1 0	314
[[:SENSe]:MONitor:POWer[:RF]:RANGe:AUTO	314
[[:SENSe]:MONitor:SWEep:POINts?	315
[[:SENSe]:MONitor:SWEep:TIME <value>	315
[[:SENSe]:MONitor:SWEep:TIME:AUTO OFF ON 0 1	315
[[:SENSe]:MONitor:SWEep:TIME:AUTO?	315
[[:SENSe]:MONitor:SWEep:TIME?	315
[[:SENSe]:POWer[:RF]:PADJust <freq>	340
[[:SENSe]:POWer[:RF]:PADJust?	340
[[:SENSe]:SWEep:POINts?	338
[[:SENSe][:NFIGure]:AVERage:COUNt <integer>	316
[[:SENSe][:NFIGure]:AVERage:COUNt?	316
[[:SENSe][:NFIGure]:AVERage:TCONtrol?	316
[[:SENSe][:NFIGure]:AVERage[:STATe] OFF ON 0 1	316
[[:SENSe][:NFIGure]:AVERage[:STATe]?	316
[[:SENSe][:NFIGure]:BANDwidth BWIDth[:RESolution] <freq>	317
[[:SENSe][:NFIGure]:BANDwidth BWIDth[:RESolution]:AUTO OFF ON 0 1	318
[[:SENSe][:NFIGure]:BANDwidth BWIDth[:RESolution]:AUTO?	318
[[:SENSe][:NFIGure]:BANDwidth BWIDth[:RESolution]?	317
[[:SENSe][:NFIGure]:CORRection:COLLect[:ACQuire] STANdard	319
[[:SENSe][:NFIGure]:CORRection:ENR:AUTO[:STATe] ON OFF 1 0	319
[[:SENSe][:NFIGure]:CORRection:ENR:AUTO[:STATe]?	320
[[:SENSe][:NFIGure]:CORRection:ENR:CALibration:TABLE:COUNt?	320
[[:SENSe][:NFIGure]:CORRection:ENR:CALibration:TABLE:DATA <frequency, <amplitude>[,<frequency>, <amplitude>].	320
[[:SENSe][:NFIGure]:CORRection:ENR:CALibration:TABLE:DATA?	320
[[:SENSe][:NFIGure]:CORRection:ENR:CALibration:TABLE:ID :DATA <string>	321
[[:SENSe][:NFIGure]:CORRection:ENR:CALibration:TABLE:ID :DATA?	321
[[:SENSe][:NFIGure]:CORRection:ENR:CALibration:TABLE:SERial :DATA <string>	321
[[:SENSe][:NFIGure]:CORRection:ENR:CALibration:TABLE:SERial :DATA?	321
[[:SENSe][:NFIGure]:CORRection:ENR:CALibration:TABLE:SNS	322

List of Commands

[:SENSe][:NFIGure]:CORRection:ENR:COMMon[:STATe] ON OFF 1 0	322
[:SENSe][:NFIGure]:CORRection:ENR:COMMon[:STATe]?	322
[:SENSe][:NFIGure]:CORRection:ENR:MEASurement]:TABLE:SNS	324
[:SENSe][:NFIGure]:CORRection:ENR:MODE TABLE SPOT	325
[:SENSe][:NFIGure]:CORRection:ENR:MODE?	325
[:SENSe][:NFIGure]:CORRection:ENR:SPOT <value>	326
[:SENSe][:NFIGure]:CORRection:ENR:SPOT?	326
[:SENSe][:NFIGure]:CORRection:ENR:THOT <value>	326
[:SENSe][:NFIGure]:CORRection:ENR:THOT?	326
[:SENSe][:NFIGure]:CORRection:ENR[:MEASurement]:TABLE :SERial:DATA <string>	323
[:SENSe][:NFIGure]:CORRection:ENR[:MEASurement]:TABLE :SERial:DATA?	323
[:SENSe][:NFIGure]:CORRection:ENR[:MEASurement]:TABLE:COUNT?	322
[:SENSe][:NFIGure]:CORRection:ENR[:MEASurement]:TABLE:DATA <frequency, <amplitude>[,<frequency>, <amplitude>]	324
[:SENSe][:NFIGure]:CORRection:ENR[:MEASurement]:TABLE:DATA?	324
[:SENSe][:NFIGure]:CORRection:ENR[:MEASurement]:TABLE:ID :DATA <string>	323
[:SENSe][:NFIGure]:CORRection:ENR[:MEASurement]:TABLE:ID :DATA?	323
[:SENSe][:NFIGure]:CORRection:LOSS:AFTer:MODE FIXed TABLE	327
[:SENSe][:NFIGure]:CORRection:LOSS:AFTer:MODE?	327
[:SENSe][:NFIGure]:CORRection:LOSS:AFTer:TABLE:COUNT?	327
[:SENSe][:NFIGure]:CORRection:LOSS:AFTer:TABLE:DATA <frequency>, <amplitude>[,<frequency>, <amplitude>]	328
[:SENSe][:NFIGure]:CORRection:LOSS:AFTer:TABLE:DATA?	328
[:SENSe][:NFIGure]:CORRection:LOSS:AFTer:VALue <value>	328
[:SENSe][:NFIGure]:CORRection:LOSS:AFTer:VALue?	328
[:SENSe][:NFIGure]:CORRection:LOSS:AFTer[:STATe] ON OFF 1 0	327
[:SENSe][:NFIGure]:CORRection:LOSS:AFTer[:STATe]?	327
[:SENSe][:NFIGure]:CORRection:LOSS:BEFore:MODE FIXed TABLE	329
[:SENSe][:NFIGure]:CORRection:LOSS:BEFore:MODE?	329
[:SENSe][:NFIGure]:CORRection:LOSS:BEFore:TABLE:COUNT?	329
[:SENSe][:NFIGure]:CORRection:LOSS:BEFore:TABLE:DATA <frequency>, <amplitude>[,<frequency>, <amplitude>]	330

List of Commands

[[:SENSe][:NFIGure]:CORRection:LOSS:BEFore:TABLE:DATA?	330
[[:SENSe][:NFIGure]:CORRection:LOSS:BEFore:VALue <value>.....	330
[[:SENSe][:NFIGure]:CORRection:LOSS:BEFore:VALue?	330
[[:SENSe][:NFIGure]:CORRection:LOSS:BEFore[:STATe] ON OFF 1 0	329
[[:SENSe][:NFIGure]:CORRection:LOSS:BEFore[:STATe]?	329
[[:SENSe][:NFIGure]:CORRection:SPOT:MODE ENR THOT.....	331
[[:SENSe][:NFIGure]:CORRection:SPOT:MODE?	331
[[:SENSe][:NFIGure]:CORRection:TCOLd:SET	331
[[:SENSe][:NFIGure]:CORRection:TCOLd:SNS[:STATe] ON OFF 1 0	331
[[:SENSe][:NFIGure]:CORRection:TCOLd:SNS[:STATe]?	331
[[:SENSe][:NFIGure]:CORRection:TCOLd:USER:VALue <temperature>.....	332
[[:SENSe][:NFIGure]:CORRection:TCOLd:USER:VALue?	332
[[:SENSe][:NFIGure]:CORRection:TCOLd:USER[:STATe] ON OFF 1 0	332
[[:SENSe][:NFIGure]:CORRection:TCOLd:USER[:STATe]?	332
[[:SENSe][:NFIGure]:CORRection:TEMPerature:AFTer <temperature>	333
[[:SENSe][:NFIGure]:CORRection:TEMPerature:AFTer?	333
[[:SENSe][:NFIGure]:CORRection:TEMPerature:BEFore <temperature>	333
[[:SENSe][:NFIGure]:CORRection:TEMPerature:BEFore?	333
[[:SENSe][:NFIGure]:DETEctor[:FUNCTion] AVERAge	333
[[:SENSe][:NFIGure]:DETEctor[:FUNCTion]?	333
[[:SENSe][:NFIGure]:FREQuency:CENTer <frequency>	334
[[:SENSe][:NFIGure]:FREQuency:CENTer?	334
[[:SENSe][:NFIGure]:FREQuency:FIXed <frequency>	334
[[:SENSe][:NFIGure]:FREQuency:FIXed?	334
[[:SENSe][:NFIGure]:FREQuency:LIST:COUNT?	336
[[:SENSe][:NFIGure]:FREQuency:LIST:DATA <frequency>[,<frequency>]	335
[[:SENSe][:NFIGure]:FREQuency:LIST:DATA?	335
[[:SENSe][:NFIGure]:FREQuency:MODE SWEep?	336
[[:SENSe][:NFIGure]:FREQuency:MODE SWEep FIXed LIST	336
[[:SENSe][:NFIGure]:FREQuency:SPAN 	336
[[:SENSe][:NFIGure]:FREQuency:SPAN?	336

[:SENSe][:NFIGure]:FREQuency:StARt <start frequency>.....	337
[:SENSe][:NFIGure]:FREQuency:StARt?	337
[:SENSe][:NFIGure]:FREQuency:StOP <stop frequency>.....	337
[:SENSe][:NFIGure]:FREQuency:StOP?	337
[:SENSe][:NFIGure]:MANual:MWAVe:FIXed <attenuation>	338
[:SENSe][:NFIGure]:MANual:MWAVe:FIXed?	338
[:SENSe][:NFIGure]:MANual:RF:FIXed <attenuation>	340
[:SENSe][:NFIGure]:MANual:RF:FIXed?	340
[:SENSe][:NFIGure]:POWer[:RF]:GAIN[:STATe] ON OFF 1 0	338
[:SENSe][:NFIGure]:POWer[:RF]:GAIN[:STATe]?	338
[:SENSe][:NFIGure]:SWEep:POINts <integer>.....	338

1 Getting Started

This chapter describes how to install the Noise Figure measurement personality (Option 219) on ESA-E Series. It also shows how to license the option so you are in a position to make your noise figure measurements.

What You will Find in this Chapter

This chapter takes you through all the necessary steps to install and license the Noise Figure Measurement personality on ESA-E Series analyzers. This chapter covers:

- [Introduction](#)
- [Available Measurement Personality Options](#)
- [Installing an Optional Measurement Personality](#)
- [Installing a License Key](#)
- [Starting the Noise Figure Personality](#)
- [Saving the Instrument State](#)
- [Keeping Your Measurement Data and Instrument Setups Secure](#)

Introduction

The Option 219 Noise Figure Measurement Personality is a downloadable program (DLP) that is used with the ESA Series and the PSA Series of spectrum analyzers. You need the following equipment to use the utility:

Table 1-1 Hardware, Firmware and Software Requirements

	Firmware	Software	Hardware	
Analyzer Model	Revision Number	Noise Figure Measurement Personality	Noise Source Control Assembly	Option 1DS Internal Pre-amp (100 kHz - 3 GHz)
ESA-E Series of Analyzers	A.12.00 or later	Option 219	Rev. 'a' or later	Recommended

NOTE

For All Models - Agilent Technologies recommends that you have Option 1DS (Internal 100 kHz - 3 GHz Preamplifier) for greatest accuracy in your measurements. The pre-amp is required for specified performance below 3 GHz.

NOTE

The Noise Figure Measurement personality (Option 219) includes the Noise Source Control Assembly which must be installed in an available card cage slot. The Noise Source Control Assembly supplies the +28 V output to drive the normal noise sources, (346A, 346B, or 346C), and an output to drive the SNS Series of noise sources (N4000A, N4001A, or N4002A). To check whether or not the Noise Source Control Assembly has already been installed, press **System**, then **Show System**, and verify that 'Noise Source Control Assembly' appears in one of the listed slots. It will typically be in slot number 3. Refer to <http://www.agilent.com/find/esa> for further information.

The next sections describe how to install and access the Noise Figure personality.

Installing the Noise Figure Personality

There are two stages to installing a measurement personality. These are:

1. Install the measurement personality firmware into the analyzer memory. See [“Installing an Optional Measurement Personality” on page 28](#)
2. Enter a license key number that activates the measurement personality. See [“Installing a License Key” on page 30](#).

Adding additional measurement personalities requires the purchase of a retrofit kit for the desired option. The retrofit kit contains the measurement personality firmware and an option entitlement certificate. This documents the product, upgrade option number, description, and quantity of licenses that can be redeemed from the Agilent website.

Available Measurement Personality Options

Table 1-2

Measurement Personalities and their Option Numbers

Available Personality Options ^a	Option Number on ESAs
GSM (with EDGE) measurement personality	202, 252
GSM (GPRS) measurement personality	BAH
Noise Figure measurement personality	219
Distance to Fault	225
Phase noise measurement personality	226
CATV	227
Bluetooth measurement personality	228
Modulation Analysis measurement personality	229
BenchLink Web Remote Control software	230
ESA to 89600 Series software link update	231
859x Code Compatibility	290
859x/856x/8566/8568 Code Compatibility	266
cdmaOne measurement personality	BAC

a. Available as of the print date of this guide.

Installing an Optional Measurement Personality

NOTE These installation instructions apply only to ESA-E series of analyzers, that is, models E4401B, E4402B, E4404B, E4405B, and E4407B.

The Noise Figure personality comes on two floppy disks. To install the utility into the spectrum analyzer use the following steps.

1. Press **System**.
2. Press **More 1 of 3**, **More 2 of 3**, then **Personalities**. The display screen will list the personalities currently installed in your spectrum analyzer.
3. Insert your Noise Figure personality floppy disk into the analyzer's disk drive and press **Install**. The installer utility will ask you to install or verify the disk. Press **Install Now** to install the personality.

NOTE Previously installed versions of the Noise Figure personality will be overwritten when the new personality is installed. If you try to install a version of the personality which has already been installed, the installation will be skipped.

4. After the installation is complete exit the installer by pressing **Exit Installer** and power cycle the analyzer.
5. To verify that the Noise Figure personality was properly installed, press **System**, **More 1 of 3**, **More 2 of 3**, then **Personalities**, and check that **Noise Figure** appears in the list of Installed Personalities.
6. The Licensed column in this table will indicate whether or not the Noise Figure application has been licensed. If the Noise Figure application has not been licensed, please refer to [“Installing a License Key” on page 30](#) for instructions to do this.

You may not be able to fit all of the available measurement personalities into the analyzer memory at the same time. To determine how much memory is available for the installation of measurement personalities on your ESA, press **File**, **Catalog**, and **Dir Select**. Now use the arrow keys to select **[-C-]**, and press **Dir Select** again. The amount of memory listed as 'Free' is the amount of memory available for extra measurement personalities.

The approximate memory requirements for the options are listed below. These numbers are worst case examples. Many options share components/libraries so the total memory usage of multiple options may

not be exactly equal to the combined total.

Table 1-3 **ESA Measurement Options and their File Sizes**

Option	Available Personality Options ^a	File Size
219	Noise Figure measurement personality	1.6 MB
225	Cable Fault Location measurement personality	0.6 MB
226	Phase Noise measurement personality	1.1 MB
227	CATV measurement personality	1.0 MB
228	Bluetooth measurement personality	1.32 MB
229	Modulation Analysis measurement personality	1.7 MB
266	8566/68 Series Code Compatibility	0.24 MB
290	859x Code Compatibility	0.7 MB
BAC	cdmaOne measurement personality	2.8 MB
BAH	GSM/GPRS measurement personality	3.2 MB

a. Correct as of the print date of this guide.

To determine how much memory is available for the installation of measurement personalities on your ESA, press **File**, **Catalog**, and **Dir Select**. Now use the arrow keys to select [-C-], and press **Dir Select** again. The amount of memory listed as 'Free' is the amount of memory available for extra measurement personalities.

You can download an updated version of firmware to your PC, and then create your own firmware upgrade disks. Instructions for downloading future firmware updates are available at the following URL:
www.agilent.com/find/esa/

Installing a License Key

To install a license key number for the selected option, use the following procedure.

NOTE You can also use this to reinstall a license key number that has been deleted during an uninstall process, or lost due to a memory failure.

NOTE If a licensing keyword was not provided, get in touch with your Agilent Technologies representative. Refer to [“Contacting Agilent” on page 356](#) for contact numbers and addresses.

1. Press **System, More, More, Licensing, Option**. The **Option** key accesses the alpha editor menu. Use the alpha editor to enter letters (upper-case) and the front-panel numeric keys to enter numbers for the option designation. As you enter the option code, you will see your entry in the active function area of the display.
2. Press **Enter**.
3. Press **License Key**. Enter the letters/digits of your license key. You will see your entry in the active function area of the display. When you have completed entering the license key number, press **Enter**.
4. Press **Activate License**.

Starting the Noise Figure Personality

The noise figure personality can be started easily once the program has been licensed and installed.

Press **MODE**, then **Noise Figure** to start the utility.

Saving the Instrument State

Saving an instrument state when in Noise Figure mode will save the entire measurement mode and measurement setup with the exception of trace and limit lines. This means that when you save the state (press **File**, then **Save**, and set **Type** to **State**), you can save all current settings, including:

- ENR data
- Frequency Lists
- Loss Compensation Lists
- Resolution Bandwidth settings
- Calibration data

Loading a state that has been saved at any time from the Noise Figure mode will force the analyzer to switch to Noise Figure mode, and will overwrite any existing settings with those that were valid when the state was last saved.

NOTE

Limit lines and trace data are not saved in the instrument state. They must be explicitly saved using the **File** and **Save** keys, and setting **Type** to the appropriate setting.

Table 1-4 Saving the Instrument State

Table / Parameter	Saved in State ^a	Saved as a file	Survives Preset	Survives Mode Switch	Survives Power Cycle
ENR Tables	Yes	Yes	Yes	Yes	Yes
Freq List	Yes	Yes	No	Yes	No
Loss Comp Table	Yes	Yes	No	Yes	No
Limit Lines	No	Yes	Yes	Yes	Yes
Correction data (Calibration)	Yes	No	Yes	Yes	No

a. Settings saved in a Save State operation can be recalled by pressing the **File**, **Load** and **Type** keys. They can also be recalled using a **Power On Last** or a **User Preset** operation.

Keeping Your Measurement Data and Instrument Setups Secure

There are three different levels of security which you can use to protect your data from unauthorized access or viewing. These are:

- Blanking the display
- Erasing your user files
- Erasing all memory, including the operating system

Refer to <http://www.agilent.com/find/security> for further information on these facilities.

CAUTION

If you need to use any of these security functions, Agilent Technologies strongly recommend that you read all the relevant instructions first. Failure to follow the instructions exactly may render your analyzer inoperable. You will then have to return your analyzer to an Agilent Service Center to have it restored to a working condition.

2

Making Basic Measurements

This chapter describes how to make basic noise figure measurements using your analyzer using Option 219, the Noise Figure Measurement application, and also covers the most common measurement related tasks.

What You will Find in this Chapter

This chapter describes the procedures to set up Option 219, the Noise Figure Measurement application, and uses a basic example to demonstrate measuring the noise figure and gain of a device such as an amplifier which performs no frequency conversion. This chapter covers.

- [Entering Excess Noise Ratio \(ENR\) Data](#)
- [Setting the Measurement Frequencies](#)
- [Setting the Bandwidth and Averaging](#)
- [Calibrating the Analyzer](#)
- [Displaying the Measurement Results](#)
- [Indicating an Invalid Result](#)
- [Example of a Basic Amplifier Measurement](#)

Entering Excess Noise Ratio (ENR) Data

You can enter ENR data for the noise source you are using as a table of values or as a single spot value. The values held in the table can be used for measurements at a range of frequencies as well as at a fixed frequency.

The single spot value is used either for measurements at a single frequency, or for measurements across a range of frequencies that is narrow enough such that the ENR value does not change significantly across that range.

There are two types of noise source. The first type, for example an Agilent 346B, is a normal noise source that is powered by a pulsed +28 V supply. These need their ENR data to be entered manually, either by using the ENR data stored previously on a diskette (such as that supplied with Agilent noise sources) or by using the keypad.

The other type of noise source, for example an Agilent N4000A, is known as a Smart Noise Source (SNS). These Smart Noise Sources require a special socket to connect to the analyzer which only the ESA-E series of analyzers have.

Selecting a Common ENR Table

You can use the same, Common, ENR table both for calibration and for making measurements, or you can use separate measurement ENR and calibration ENR tables. You need separate measurement and calibration tables when separate noise sources are used for DUT measurements and for calibration. An example of this is when you are using frequency converters, and the calibration range is different than the measurement range.

NOTE

ENR tables can contain up to 401 frequency points.

To use the same ENR table for calibration and measurement, press the **Meas Setup** key and then the **ENR** key. Press the **Common Table** key to select **On**. This configures the analyzer to use a common ENR table both for measurements and for calibration.

The default setting for **Common Table** is **On**. In this mode the **Cal Table...** is not accessible.

To use different ENR tables for calibration and measurement, press the **Common Table** key to select **Off**.

When **Common Table** is set to **Off**, the **Cal Table...** key is accessible. **Cal Table...** gives you access to the ENR table of the noise source used to calibrate your analyzer.

When **Common Table** is set to **Off**, the **Meas & Cal Table...** key is also

accessible. This gives you access to the ENR data table for the noise source used to make measurements.

When **Common Table** is set to **On**, the **Meas Table...** is used as the **Common Table**, and is used for both calibration and measurement. The analyzer's keys will then refer to the **Meas & Cal Table...** instead of the **Meas Table....**

Entering ENR Table Data for Noise Sources

If you are using a Smart Noise Source ('SNS') on an ESA-E series analyzer, you can load the ENR table data automatically. Alternatively, regardless of which type of analyzer or noise source you are using, you can manually enter ENR data in the form of an ENR table in four other ways:

- You can load the ENR data from a diskette on which the data has been previously stored. The diskette supplied with every Agilent noise source contains the ENR data for that particular noise source.
- You can load the ENR data from the internal memory, where the data has been previously stored.
- You can manually input the required frequencies and corresponding ENR values.
- You can load the ENR data over a GPIB connection. See the *ESA User's / Programmer's Reference* for more details.

NOTE

Normal noise sources from Agilent Technologies have the ENR values printed on the body of the device. These ENR values are also provided in the form of a calibration report, and on a diskette which is supplied with every Agilent noise source. The values printed on the noise source itself are only shown to two decimal places. The values stored on a diskette are correct to three decimal places.

To load ENR data automatically from a Smart Noise Source

If you are using, or intending to use, an ESA series analyzer with a Smart Noise Source attached, you can load this ENR data into the analyzer as follows.

- Step 1.** Make sure you are in the Noise Figure mode by pressing the **Mode** hardkey and checking that **Noise Figure** is highlighted.
- Step 2.** Press the **Meas Setup** key.
- Step 3.** Press the **ENR** key.
- Step 4.** Press the **SNS Setup** key to set your SNS preferences.
- Step 5.** On the **Auto Load ENR** key, make sure the word **On** is underlined. If **Off** is underlined, press the **Auto Load ENR** key once to toggle between **Off** and **On**

CAUTION

Do not remove the SNS noise source at any time that the screen is displaying the warning message indicating that the download of the ENR data is in progress. This can result in corruption of the ENR data that is held within the SNS itself.

- Step 6.** If your SNS noise source is already connected to your ESA analyzer, the **Common Table** will be switched **On**, and the table will be loaded with the ENR data (including serial number and model ID). If your SNS is not yet attached, you will need to attach it now. The Common Table will then be loaded as soon as the connection is made.

To load ENR data from diskette or from memory

If the noise source you are using has its ENR data supplied or previously stored on a diskette or internal memory, you can load this ENR data into the analyzer as follows.

- Step 1.** If the ENR file is on diskette, insert the diskette into the floppy drive of the analyzer.
- Step 2.** Press the **File** key.
- Step 3.** Press the **Load** key to access the file system.
- Step 4.** Select the type of file you wish to load by pressing the **Type** key and then either the **ENR Meas/Common Table** key or the **ENR Cal Table** key.

A list of available files on the [-A-] or [-C-] drive is displayed.

- Step 5.** Select the drive from which you wish to load ENR data by pressing the **Dir Up** key, and then selecting the drive by using the up and down arrows and pressing the **Dir Select** key.

A list of available files on the specified [-A-] or [-C-] drive is displayed. Use the arrow keys to access the appropriate file.

- Step 6.** Select the file from which to load the data by using the Up and Down arrows. Once you have highlighted the correct file, press the **Load Now** key.

To enter ENR table data manually

NOTE

When you are entering ENR data for the first time, the ENR table is empty. You can create this condition in Option 219 Noise Figure Measurement which has been used previously by pressing the **Meas Setup** key, followed by **ENR**. Look at the Common Table softkey to check whether Common Table is On or Off. If Common Table is On, press **Meas & Cal Table...**, and Tab down to any point in one of the rows in the table. Press **More, Delete All**.

If Common Table is Off, press **ENR, Meas Table...** or **Cal Table...**, and Tab down to any point in one of the rows in the table. Press **More**, and **Delete All**. The typical display is shown in [Figure 2-1](#).

Enter the ENR data manually as follows:

- Step 1.** Press the **Meas Setup** key, followed by the **ENR** key, and then the **Meas Table...** key, the **Cal Table...** key, or the **Meas & Cal Table...** key.

- Step 2.** Now select the ENR table for which you wish to enter data.

To enter common measurement and calibration ENR data, make sure that **Common Table** is set to **On**, and press the **Meas and Cal Table** key.

To enter either measurement ENR data or calibration ENR data, make sure that **Common Table** is set to **Off**, and then select your table by pressing either **Meas Table...** or **Cal Table...**

An **ENR Table** appears on the display with the first frequency point in the table highlighted (see [Figure 2-1](#)).

Figure 2-1 An Empty ENR Table

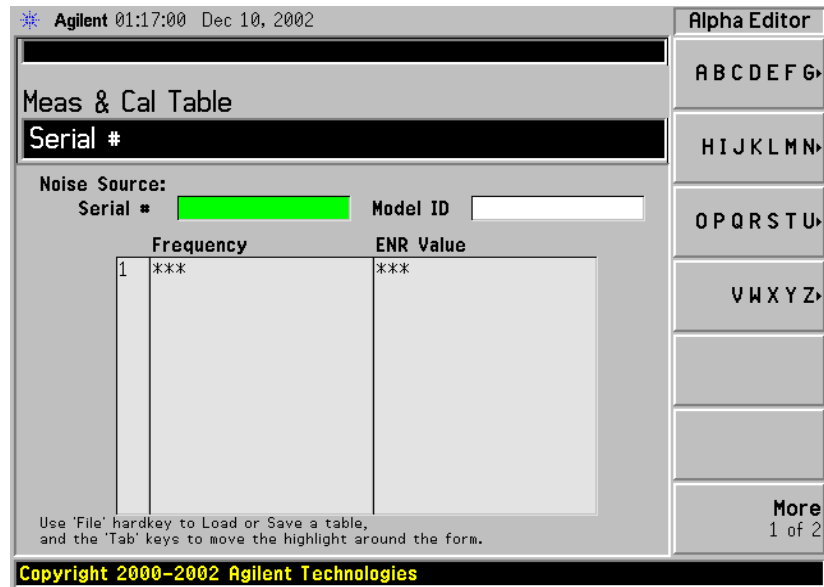

Step 3. Optional Step

Tab to the **Serial #** field, or Tab to any of the rows of data in the table and press the **Serial #** key, and enter the noise source serial number using the numeric keys and the Alpha Editor.

Step 4. Optional Step

Tab to the **Model ID** field, or Tab to any of the rows of data in the table and press the **Model ID** key, and enter the noise source model number using the numeric keys and the Alpha Editor.

Step 5. Tab to the first column (Row number) in the ENR data table.

The table editing and navigation menu items now appear.

Step 6. Either press the **Tab** → key or press the **Frequency** key to move the highlight to the **Frequency** column. Enter the frequency value in the table using the numeric keys. Terminate it using the unit menu keys.

Step 7. Either press the **Tab** → key or press the **ENR Value** key to move the highlight to the ENR Value column. Enter the corresponding ENR value of the ENR list.

When terminating the ENR value you can use either **dB**, **K** (Kelvin), **C** (degrees Centigrade), or **F** (degrees Fahrenheit) menu keys. The **K**, **C**, or **F** entry is converted to appear in the table as dB.

Step 8. Either press the **Tab** → key or press the **Frequency** key to move the highlight to the **Frequency** column. Enter the next frequency value on the ENR list.

Step 9. Read the note (below) or repeat steps 7 to 8 until all the frequency and ENR values you need are entered.

NOTE The ENR Table data is stored in CSV (Comma Separated Value) format. It is sometimes more convenient to use a text editor on a PC to edit or enter this data rather than to enter the data manually using the analyzer. Start by saving at least one ENR value to diskette, and then edit or add to the saved file using your PC.

Step 10. After completing the ENR table entries, press the **Return** key or **ESC** key to return to the ENR menu.

Step 11. Optional Step

Once you have completed entering the ENR data, you can save the ENR table using the **File** key.

For details on saving files, see “Saving an ENR Table” on page 43.

Figure 2-2 A Typical ENR Table after data entry

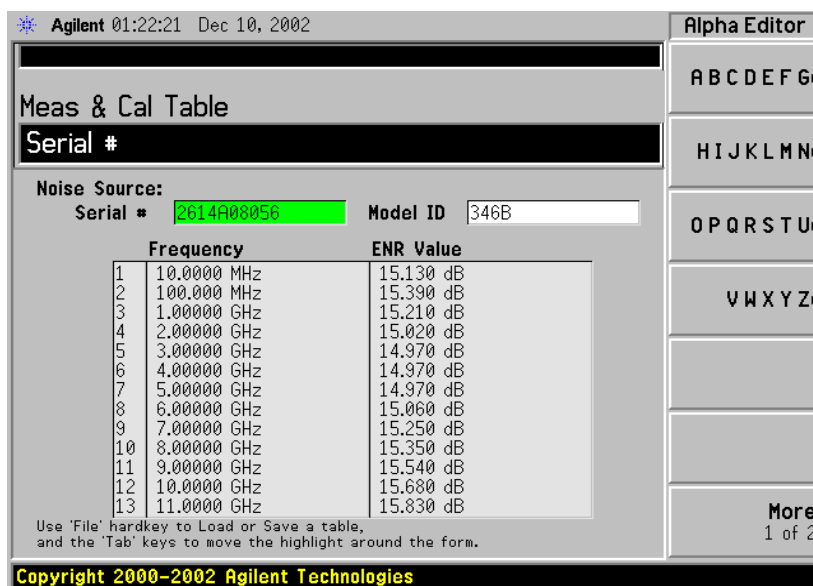

NOTE ENR table data survives a power cycle and preset. You only need to explicitly save ENR data if you have more than one noise source.

NOTE You can insert the frequencies into the ENR Table entry in any order, as the analyzer automatically sorts the frequency list into ascending order.

NOTE When results are needed at frequencies between those entered in the ENR tables, a linearly interpolated value is automatically used at those frequencies.

Saving an ENR Table

You can save an ENR table either to the analyzer's internal memory or to floppy disk as follows:

Step 1. Press the **File** key.

Step 2. Press the **Save** key.

Step 3. Select the type of file you wish to save by pressing the **Type** key and then either the **ENR Meas/Common Table** key or the **ENR Cal Table** key.

A list of existing files on the [-A-] or [-C-] drive is displayed.

Step 4. Select the drive to which you wish to save the ENR data by pressing the **Dir Up** key, and then selecting the drive by using the up and down arrows and pressing the **Dir Select** key.

A list of existing files on the specified [-A-] or [-C-] drive is displayed.

Step 5. You can either accept the default filename that the analyzer has displayed at the top of the screen, or you can specify your own. To specify your own filename press the **Name** key, and then specify the name using the Alpha editor and the numeric keys on the front panel.

NOTE

Although the file extension is shown in the default filename, you must not include the file extension when specifying your own filename. The file extension is determined by the type of file you tell the analyzer you are saving. It is added automatically to the filename you specify.

Step 6. Press the **Save Now** key to save the file.

Entering a Spot ENR Value

A Spot ENR value can be applied across the whole measurement frequency range, or when making a measurement in fixed frequency mode, you can enter a specific spot ENR value corresponding to the fixed frequency.

To enter a Spot ENR value:

- Step 1.** Press the **Meas Setup** key and the **ENR** key.
- Step 2.** Press the **Spot** key.
- Step 3.** Press the **Spot ENR** key.
- Step 4.** Enter an ENR value using the numeric keys and terminate it using the unit termination menu keys. The default value is 15.20 dB.

NOTE

If you are using a noise source with a calibrated ENR list and the frequency you want to measure is not a listed ENR value, then you need to interpolate the ENR list to an appropriate value.

To Enable Spot ENR Mode

- Step 1.** Press the **Meas Setup** key and the **ENR** key.
- Step 2.** Press the **ENR Mode** key to select **Spot**.

Entering a Spot T_{hot} Value

When making measurements, you can enter a specific **Spot Thot** value. The **Spot Thot** value is applied across the whole measurement frequency range

To enter a Spot T_{hot} value:

- Step 1.** Press the **Meas Setup** key, the **ENR** key, then the **Spot** key.
- Step 2.** Press the **Spot T hot** key.
- Step 3.** Enter a T_{hot} value using the numeric keys and terminate it using the unit termination menu keys. The default value is 9892.80 K.

NOTE

You can enter T_{hot} temperatures in degrees centigrade (C), in degrees Fahrenheit (F), or in Kelvin (K). Whatever units you use when entering the T_{hot} temperature, the temperature will be converted automatically and displayed in K.

To Enable Spot T_{hot} Mode

- Step 1.** Press the **Meas Setup** key and the **ENR** key.
- Step 2.** Press the **ENR Mode** key to select **Spot**.
- Step 3.** Press the **Spot** key.
- Step 4.** Press the **Spot State** key and select **Thot**.

Setting the T_{cold} value

When making measurements in different ambient temperature conditions you can change the T_{cold} value manually.

The default temperature value is set at 296.50 K (23.25° C or 73.85° F). The **T cold** key is set to **Default** to confirm this default temperature.

If you are using a Smart Noise Source (SNS) on an ESA series analyzer, you can choose to let the SNS supply the T_{cold} value. The T_{cold} value will be extracted once for each completed cycle of all the frequency points.

Changing the User T_{cold} value manually (*PSA series analyzers only*)

To change the User T_{cold} value:

- Step 1.** Press the **Meas Setup** key and the **ENR** key.
- Step 2.** Press the **T cold** key so that **User** is underlined.
- Step 3.** Enter the T_{cold} temperature using the numeric keys on the front panel, and terminate it by selecting the unit termination menu keys.

NOTE You can enter T_{cold} temperatures in degrees centigrade (C), in degrees Fahrenheit (F), or in Kelvin (K). Whatever units you use when entering the T_{cold} temperature, the temperature will be converted automatically and displayed in K.

Changing the User T_{cold} value manually (*ESA series analyzers only*)

To change the User T_{cold} value:

- Step 1.** Press the **Meas Setup** key and the **ENR** key.
- Step 2.** Press the **T cold** key.
- Step 3.** Press the **User T cold** key so that **User** is underlined.
- Step 4.** Enter the T_{cold} temperature using the numeric keys on the front panel, and terminate it by selecting the unit termination menu keys.

NOTE You can enter T_{cold} temperatures in degrees centigrade (C), in degrees Fahrenheit (F), or in Kelvin (K). Whatever units you use when entering the T_{cold} temperature, the temperature will be converted automatically and displayed in K.

Using the User T_{cold} value extracted automatically from an SNS

To get the ESA series analyzer to use the User T_{cold} value supplied by the SNS:

- Step 1.** Press the **Meas Setup** key and the **ENR** key.
- Step 2.** Press the **T cold** key.
- Step 3.** Press the **User T cold** key so that **User** is underlined.
- Step 4.** Press the **User Tcold From SNS** key. A new T_{cold} temperature will be extracted from the SNS every time a new cycle of measurements is made at your specified frequencies.

Setting the Measurement Frequencies

Before you set the frequencies you want to measure, you need to select a frequency mode. Three frequency modes are available:

- **Sweep** — the measurement frequencies are obtained from the start and stop (or equivalent center and span) frequencies and the number of measurement points.
- **List** — the measurement frequencies are obtained from the frequency list entries.
- **Fixed** — the measurement frequency is taken at a single fixed frequency.

Using Sweep Frequency Mode

In sweep frequency mode you set the start and stop frequencies (or equivalent center and span frequencies) over which the sweep is made. You also need to set the number of measurement points. These measurement points are equally spaced over the frequency span. The maximum number of points is 401 and the default number of points is 11.

NOTE If you change the span after a calibration, and the calibration has been made over a narrower frequency range, the calibration is invalid.

To make a measurement over a specific frequency range:

- Step 1.** Press the **Frequency/Channel** key.
- Step 2.** Press the **Freq Mode** key.
- Step 3.** Press **Sweep** to select Sweep mode.
- Step 4.** Set the frequency range by either entering the **Start Freq** and **Stop Freq** frequencies, or the **Center Freq** and the **Freq Span** key.

Use the numeric key pad to enter the value you want. Use the unit menu keys to terminate the number.

- Step 5.** Press the **Points** key.
- Step 6.** Enter the number of measurement points using the numeric keys. Press the **Enter** key to terminate.

NOTE The time required to make a measurement or to calibrate is proportional to the number of measurement points that you specify.

Using List Frequency Mode

List frequency mode allows you to enter the frequency points where measurements are made. This allows you to specify measurement points, for example, in areas of interest that would otherwise have less coverage in the sweep mode. List Frequency mode can also be used to avoid making measurements at frequencies where spurs are known to exist.

Frequency lists are limited to 401 entries.

To set the analyzer to use the data in the frequency list table:

Step 1. Press the **Frequency/Channel** key and the **Freq Mode** key.

Step 2. Press the **List** key to set the frequency mode to **List**.

You can create a frequency list in the following ways:

- Manually, by specifying each individual point.
- From the swept points, by specifying the measurement frequency range and setting the analyzer to generate equally spaced points within that range, using the **Fill** key. This list of frequencies can be edited later if required.
- Loading a list from the internal memory or from a diskette where the data has been previously stored. Lists stored on a diskette can be edited using your text editor or your PC.
- Loading a list over GPIB; see [Chapter 7](#), “Language Reference,” on [page 239](#) if you want to use this method.

To Create a Frequency List Manually

Step 1. Press the **Frequency/Channel** key.

Step 2. Press the **Freq List...** key.

A Frequency List table appears on the display.

Figure 2-3 An Empty Frequency List

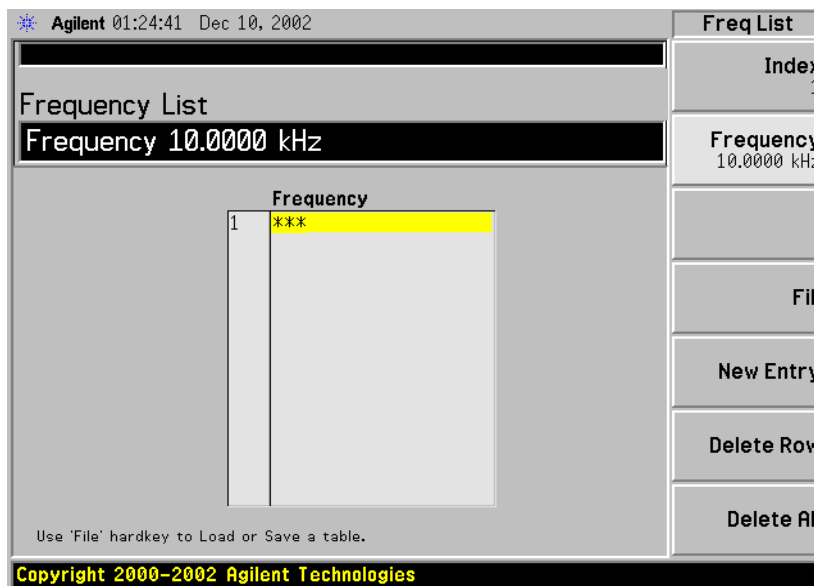

NOTE You do not need to enter the frequency values in ascending order, as the analyzer continually sorts the values into ascending order.

Step 3. Press the **Delete All** key.

You are prompted to press this key again, this feature ensures you do not accidentally clear a valid Frequency list table. Press the **Delete All** key again. Clearing the table allows you to start entering points knowing there are no previous entries remaining.

The first frequency point in the table is highlighted.

Step 4. Enter the frequency value you want using the numeric keys. Terminate it using the unit menu keys which are presented to you.

Step 5. The next frequency point in the table is automatically highlighted.

Enter the next frequency value by using the numeric key pad and the unit termination keys.

Step 6. Repeat step 5 until your list is complete.

Step 7. Save the Frequency List to the analyzer internal memory or to a diskette if required using the **File** key. See “Saving an ENR Table” on page 43 for an explanation of this.

NOTE If you do not save the frequency list, you may lose the data. This depends on your Power On/Presets condition. Table 1-4 on page 32 gives you more details.

Creating a Frequency List from Swept Points

You can create a frequency list from the swept mode frequency and

points data.

To set the analyzer to use the swept mode data:

Step 1. Press the **Frequency/Channel** key.

Step 2. Press the **Freq List...** key.

Step 3. Press the **Fill** key.

This clears the current frequency list and fills the list with the frequencies generated by the sweep frequency mode. This results in the same frequency list as setting **Frequency Mode** to **Swept**. You can use this list as a starting point, and then edit the frequencies as required.

Using Fixed Frequency Mode

The fixed frequency mode is used when you want to make a measurement at a single frequency.

NOTE

If you have not entered the noise source ENR data which you intend using for the fixed frequency mode measurement, you may specify a spot ENR value and set the ENR mode to Spot.

To set a fixed frequency:

- Step 1.** Press the **Frequency/Channel** key.
- Step 2.** Press the **Freq Mode** key to set the frequency mode to **Fixed**.
The **Fixed Freq** key is now available.
- Step 3.** Press the **Fixed Freq** key and enter the frequency value using the numeric keys and the unit termination menu keys.

Setting the Bandwidth and Averaging

Effect of Bandwidth and Averaging on Speed, Jitter, and Measurement Accuracy

Jitter is a natural occurrence when measuring noise. To reduce jitter you must increase the number of averages or increase the measurement bandwidth.

If the bandwidth is reduced, you need to increase the number of averages to maintain the same uncertainty.

The greater the number of averages chosen, the more accurate the measurement, as this reduces jitter on the measurement. However, this has to be considered against how long it takes to complete the measurement.

There is therefore a trade off between speed and the accuracy/uncertainty of a measurement.

Selecting the Resolution Bandwidth Value

When the **Res BW** is set to **Auto**, the bandwidth is set automatically, and is dependent on measurement frequency. The following table lists the RBW values at different frequencies.

Table 2-1

Resolution Bandwidth Values on the ESA Series of Analyzers

Measurement Frequency	Resolution Bandwidth
Less than 130 kHz	1 kHz
130 kHz or greater, and less than 380 kHz	3 kHz
380 kHz or greater, and less than 980 kHz	10 kHz
980kHz or greater, and less than 2.8 MHz	30 kHz
2.8 MHz or greater, and less than 7.4 MHz	100 kHz
7.4 MHz or greater, and less than 21 MHz	300 kHz
21 MHz or greater	1 MHz

CAUTION

Do not switch to DC Coupling if your input signal contains a DC component. You risk permanently damaging your analyzer's front end components if you do this.

NOTE

For greater accuracy in your noise figure measurements, Agilent recommends that you use DC Coupling for measurement frequencies below those listed in [Table 2-2 on page 54](#), and AC coupling for

frequencies greater than those listed. *When setting your analyzer to DC Coupled, make sure your input signal does not contain a DC component as you will permanently damage your analyzer.* Press the **Input/Output** key, the **Input/Output** key and the **RF Coupling** key to set your analyzer to AC or DC Coupled.

Table 2-2 When to use DC Coupling on the ESA Series of Analyzers

Model Number	Switch to DC Coupling Below this Frequency
E4401B	Always AC coupled
E4402B without Option UKB	Always AC Coupled
E4402B with Option UKB	100 kHz
E4404B with or without Option UKB	100 kHz
E4405B with or without Option UKB	100 kHz
E4407B Without Option UKB	Always DC Coupled
E4407B with Option UKB	10 MHz

Step 1. Press the **BW/Avg** key.

The current resolution bandwidth is shown on the **Res BW** key.

Step 2. Press the **Res BW** key and select whether the resolution bandwidth is to be set automatically, or to be set manually by you.

Step 3. Enter your resolution bandwidth using the numeric keys on the front panel, and terminate by using the unit termination keys.

Setting Averaging

Increased averaging reduces jitter and provides more accurate measurement results. However, the measurement speed is sacrificed. The maximum number of averages allowed is 1000, and the default value is 10. The default setting, however, is **Off**.

Enabling averaging

Averaging can be enabled by setting the **Averaging** to **On**. To disable averaging set **Averaging** to **Off**.

Setting the Number of Averages

To set the number of averages you want:

- Step 1.** Press the **Meas Setup** key, and then press the **Avg Number** key so that Averaging is set to **On**.
- Step 2.** Enter the numeric value you want using the numeric key pad. Terminate it with the **Enter** key.

Selecting the Averaging Mode

Averaging Mode is permanently set to **Repeat**. No other form of averaging is available.

With Repeat averaging, each point in a sweep is measured an **Avg Number** of times and the average figure evaluated, before moving on to the next point in the sweep.

Calibrating the Analyzer

To compensate for the noise contribution of the analyzer and associated cabling in the measurement path, a calibration is necessary. The calibration measures the analyzer's noise contribution with no DUT (device under test) in place. This correction is often referred to as the second stage calibration. The correction is then applied to the measurement with the DUT in place.

To perform calibration you need to enter the ENR values and set up the frequency range, number of measurement points, the bandwidth, the averaging, and measurement mode to be used during the measurement.

NOTE

If you alter the frequency range after you have calibrated the analyzer, it changes the analyzer's status to either the uncorrected or the interpolated corrected state. Before you can make another measurement to the specified accuracy, you will need to either recalibrate the analyzer, or to recall a previously saved state file in which the calibration data has been saved.

Corrected measurements

You can make corrected measurements only at frequencies which are covered by the current calibration. Attempting to make corrected measurements at frequencies less than the lowest calibration frequency or greater than the highest calibration frequency will generate an error and invalidate the calibration.

To proceed you must either:

- Perform a calibration over the desired measurement frequency range.
- Change the measurement frequency to one covered by the existing calibration.
- Perform uncorrected measurements. Uncorrected measurements actually measure the noise figure of the analyzer and any associated components in the input path. This can be useful if you wish to use the Uncertainty Calculator.

NOTE

If you perform a measurement outside the calibrated range of the analyzer, **Noise Figure Correction** is automatically set to **Off** and a message is displayed stating User Cal invalidated, freq outside cal range. If you then change your measurement frequency back to a frequency within the calibrated range, the previous error message will be replaced by a message stating User Cal valid. **Noise Figure Correction**, however, will still be set to **Off**. You will need to switch it **On** again to make a corrected measurement.

- When to perform calibration** To make corrected measurements, you must calibrate the analyzer whenever:
- You power cycle the analyzer.
 - You Preset the analyzer.
 - You select a measurement frequency or frequency range outside the currently calibrated range.
 - You change the RBW setting.
 - There is a large temperature variation since the last calibration.
 - The input signal level can no longer be measured using one of the calibrated input attenuator ranges.
 - When an invalid result is detected and the condition is indicated by an “xx”. See [“Indicating an Invalid Result” on page 79](#) for an explanation of these conditions.

Calibration indicator Whenever anything within the analyzer changes to invalidate the current calibration, the message `UnCorr` is displayed in red at the top left-hand corner of the display. If the analyzer has been successfully calibrated for the current frequency and measurement settings, the message `Corr` is displayed in green text at the top right-hand corner of the display.

To perform a calibration

Step 1. Verify that the correct ENR table is loaded in the analyzer, or input the ENR values of the noise source into the analyzer's Common or Calibration Table.

See “[Entering ENR Table Data for Noise Sources](#)” on page 38 for more details.

If you are using an ESA-E series analyzer with an Agilent Smart Noise Source (SNS), and you have both **Auto Load ENR** set to **On** and **SNS Preference** set to **SNS**, any Common Table (used both for measurements and for calibration) will already have been populated for you.

If you have switched **Common Table** to **Off** (that is, you are using separate measurement and calibration tables), the Calibration Table might be empty. You can populate the Calibration Table directly from the SNS by pressing **Meas Setup**, **ENR**, and then **Cal Table....** The Calibration Table will now be displayed on your analyzer. Use the **Tab** key to move the cursor to one of the rows of data in the table, and then press the **More 1 of 2** key. If you now press the **Fill Table From SNS** key, the analyzer will extract the ENR data directly from the SNS.

Step 2. Configure the measurement parameters (frequency range, number of points, bandwidth, averages, and measurement mode) you want to use for the measurement.

Step 3. Connect the noise source output directly to the analyzer input, as shown in [Figure 2-4](#).

Figure 2-4 ESA Calibration

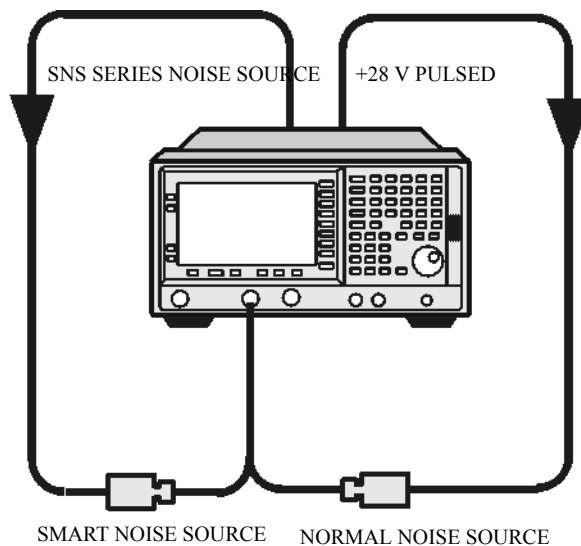

NOTE

You may need to use connector adaptors to connect the noise source output to the analyzer input during calibration. The connectors you use need to be included in the measurement. If you remove these connectors for the measurement, you need to apply Loss Compensation to compensate for any loss caused by the connectors' removal. [“Using Loss Compensation” on page 94](#) for an explanation of this.

Step 4. If required, select an input attenuator range by pressing the **Input/Output** key, followed by the **Noise Figure Corrections** key and the **Input Cal** key to set the minimum and maximum input attenuation.

See [“Selecting the Input Attenuation Range” on page 60](#) for mode details on input attenuation.

Step 5. Press the **Calibrate** key twice to initiate the calibration.

The first time you press the key you are prompted to press it again. This two-stroke key press feature prevents you from accidentally pressing **Calibrate** and erasing the existing calibration data.

The analyzer performs the calibration, displaying a percentage counter while this is happening.

When the calibration is finished the calibration indicator changes from a red **UnCorr** display to a green **Corr** display. Also the **Noise Figure Corrections** key (**Input/Output** key, **Noise Figure Corrections** key and again the **Noise Figure Corrections** key) is now available to you. This allows you to make corrected or uncorrected measurements by switching between **On** and **Off** respectively.

NOTE

Measurement performance above 3 GHz is not specified. If you do not have a preamp and you are calibrating above 3 GHz, the calibration data will vary significantly. Measurements made with this calibration data might be valid, but only if the device you are testing has a high gain. If this is not the case, the measurement accuracy will be poor. See the *ESA-E Series Specifications Guide* for more detail on operating above 3 GHz.

NOTE

When using external pre-amps or high-gain DUTs, ensure that neither the external pre-amp (or the high-gain DUT) nor the internal pre-amp go into compression as this will affect the accuracy of your measurements. If you suspect that one of the pre-amps is going into compression, use attenuation prior to that pre-amp to prevent compression. Note that the analyzer's internal attenuator will only affect compression occurring in the internal pre-amp. It will not have any effect on any compression occurring in the external pre-amp.

Selecting the Input Attenuation Range

The Noise Figure Measurement Personality, Option 219, on the ESA Series of analyzers has a default input attenuation calibration range of 0 dB to 10 dB, with a step size of 5 dB.

The greater the attenuator calibration range selected, the greater is the number of calibration sweeps, and hence, the longer the calibration routine takes.

In the Option 219 Noise Figure application, the attenuators cannot autorange. There is, therefore, a risk of overdriving the analyzer. If the signal power level is greater than -28 dBm on the ESA-E Series, the preamp will go into compression and the accuracy of your results will be adversely affected. In most cases, 0 dB attenuation is adequate. A guide to the input powers that can be handled by ESA Series analyzers at each frequency range is shown in [Table 2-3 on page 61](#).

To check for overdriving of the analyzer, that is, compression occurring at the preamp stage, set the attenuation to 0 dB and note the noise figure of your DUT. Now increase the attenuation by one step by pressing the up-arrow key. If your noise figure changes by more than 0.5 dB, attenuation is required. Repeat this process until you have found the lowest level of attenuation that gives you a stable noise figure result, and use this attenuation level for your measurements.

Table 2-3 Power Detection and Ranging on ESA-E Series Analyzers^a

Frequency	Attenuation Setting	Maximum Input Power for High Accuracy	Approximate DUT Characteristics
10 MHz to 3 GHz ^b	0 dB	-28 dBm	Over the full bandwidth, a DUT with NF = 5 dB and Gain = 43 dB, or a DUT with NF = 15 dB and Gain = 36 dB
10 MHz to 3 GHz ^b	5 dB	-33 dBm	Over the full bandwidth, a DUT with NF = 5 dB and Gain = 48 dB, or a DUT with NF = 15 dB and Gain = 41 dB
10 MHz to 3 GHz ^b	10 dB	-38 dBm	Over the full bandwidth, a DUT with NF = 5 dB and Gain = 53 dB, or a DUT with NF = 15 dB and Gain = 46 dB
10 MHz to 3 GHz ^b	15 dB	-43 dBm	Over the full bandwidth, a DUT with NF = 5 dB and Gain = 58 dB, or a DUT with NF = 15 dB and Gain = 51 dB
3 GHz to 26.5 GHz ^c	0 dB	-12 dBm	

- a. The figures given in the table (above) for 10 MHz to 3 GHz assume a 5 dB ENR noise source and that the preamp is On. The figures for 3 GHz to 26.5 GHz assume a 15 dB ENR noise source.
- b. If the DUT has a narrower bandwidth than the 200 kHz to 3 GHz specified here, the DUT characteristics can be increased accordingly. For example, if the DUT has a bandwidth of 100 MHz, the DUT characteristics can be increased by a factor of $10 \times \log(3 \times 10^9 / 100 \times 10^6)$, that is, by 15 dB. In this example using an attenuation setting of 0 dB, the Gain of a DUT with a 15 dB Noise Figure can be increased from 36 dB to 51 dB.
- c. In the 3 – 26.5 GHz frequency range, a pre-amp is recommended. Attenuation levels greater than 0 dB have been omitted from the table (above) because the external pre-amp and the DUT will be the limiting factors for compression. The analyzer attenuators are after the external pre-amp and the DUT, and would therefore not improve the compression. The preselector has a bandwidth of between 30 MHz and 70 MHz, depending on frequency (higher frequencies have higher bandwidths).

To select the input attenuation calibration range:

- Step 1.** Press the **Input/Output** key.
- Step 2.** Press the **Noise Figure Corrections** key.
- Step 3.** Press the **Input Cal** key and select the attenuation range you want
- Step 4.** Set the attenuator range using the **Min Atten** and **Max Atten** keys, and enter the required attenuation calibration range using the numeric keys on the front panel. Terminate the attenuator range entry by pressing the **dB** key. Use [Table on page 61](#) as a guide to what range you require.

Setting the Input Attenuation after a Calibration

The attenuators cannot autorange. Hence, when making a measurement you must manually set the input attenuation to avoid overdriving the analyzer. To set the input attenuation:

- Step 1.** Press the **Input/Output** key.
- Step 2.** Press the **Attenuation** menu key and enter the desired measurement attenuation using the numeric keys on the front panel. Press the **dB** key to complete the attenuation setting.

Displaying the Measurement Results

The analyzer features a color display and a comprehensive set of display features to allow you to analyze the measurement results in detail, or to quickly obtain pass/fail indication.

The following display format features are available:

- Graph, Table or Meter mode display
- Single or dual-graph display allowing any two available result types to be displayed simultaneously
- Zoom to display only one result graph on the display
- Combine option to display two result types on the same graph
- Markers for searching a trace, and for displaying point data more accurately than can be done with a trace alone
- Save the current active trace data to memory
- Switch the graticule on or off
- Switch display annotation on or off

Selecting the Display Format

You can display the measurement results in either:

- Graph format
- Table format
- Meter format

The default display provides a display of noise figure and gain on the dual-graph display. The upper graph is noise figure and the lower graph is gain.

In all formats you can choose two result parameters you want to display.

To set the display format:

Step 1. Press the **Trace/View** key.

Step 2. Select the **Graph**, **Table** or **Meter** key to select the display mode you want.

Navigating Around the Display

Active Graph

The active graph is highlighted by a green border. Noise Figure is the active graph by default.

Figure 2-5 Dual-graph display



Changing the Active Graph

To change the active graph, press the **Next Window** key below the display. This key allows you to set the upper or lower graph as the active graph.

Viewing the Full Screen

You can fill the entire display and remove the menu keys, the active function area annotation, and the display status line annotation from the display. Press the **Display** key and the **Full Screen** key to view the full screen. Pressing any key except **Save**, **Print** or the numeric keys returns to the previous display.

NOTE

The **Full Screen** key also functions in table or meter format.

Selecting Result Types to Display

You can choose to display any pair of measurement results in all of the display format modes.

The measurement result types are as follows, with their units in parentheses:

- Noise Figure (dB)
- Noise Factor (linear power, measured in watts)
- Gain (dB)
- Y Factor (dB)
- T effective (Kelvin, K)
- P hot (dB)
- P cold (dB)

To specify which measurement results are displayed

- Step 1.** Press the **Trace/View** key.
- Step 2.** Press the **Result A** key and select the result type that you want to display. These results will be displayed in the upper display window when **Meas View** is set to **Graph**, and in the left-hand column when **Meas View** is set to **Table**.
- Step 3.** Press the **Result B** key and select the result type that you want to display. These results will be displayed in the lower display window when **Meas View** is set to **Graph**, and in the right-hand column when **Meas View** is set to **Table**.

NOTE

If you press the **Amplitude/Y Scale** key while **Meas View** is set to **Graph**, the scale menu keys for the active measurement are shown.

Graphical Features

Viewing a single graph

While in graph format mode, you can press the **Zoom** key located below the display and the active graph fills the display as a single graph, as shown in [Figure 2-6](#). Pressing the **Zoom** key again returns the display to dual-graph.

Figure 2-6 **Displaying a single graph**

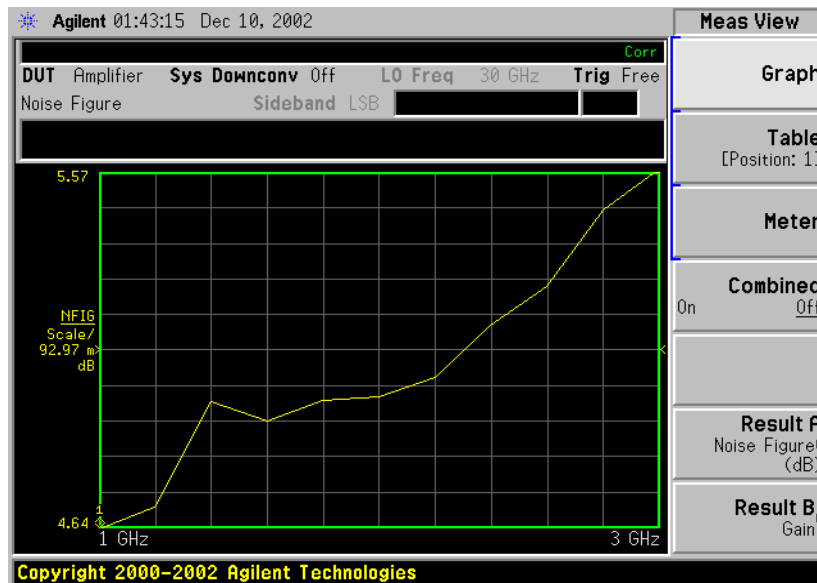

NOTE When in single graph mode, pressing the **Next Window** key displays the other single graph.

Combining two traces on the same graph

You can combine the upper and lower graphs from a dual-graph display into a single combined display. By default, the **Combined** setting is **Off** and the graphs are not combined.

NOTE

When combining two graphs, the Y-scale result limits are not re-scaled. Both graphs have their own Y-scale result limits which are indicated in different colors. These colors correspond to the colors of the traces in the combined graph.

To combine the two graphs:

- Step 1.** Press the **Trace/View** key and ensure **Graph** is selected.
- Step 2.** Press the **Combined** key and toggle to the **On** setting to combine the two currently displayed graphs on the same graph.

Figure 2-7 Typical display with two traces combined on the same graph

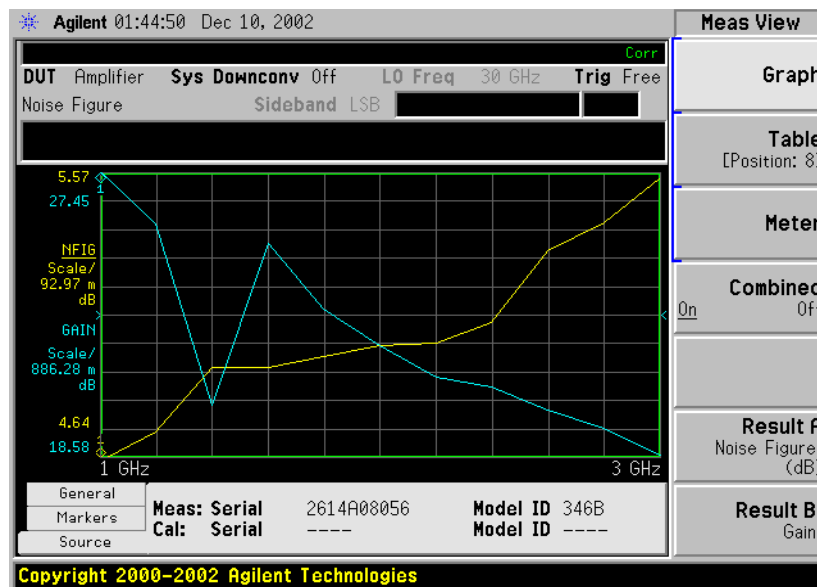

Turning the Graticule On and Off

When **Graticule** is set to **On**, the graticule divisions are displayed on the screen. This is the default setting. When **Graticule** is set to **Off**, the graticule lines are not displayed on the screen.

To turn the graticule on or off:

- Step 1.** Press the **Display** key.
- Step 2.** Press the **Preferences** key.
- Step 3.** Press the **Graticule** key to select the **Off** or **On** as required.

Figure 2-8 Typical Graph with Graticule Switched Off

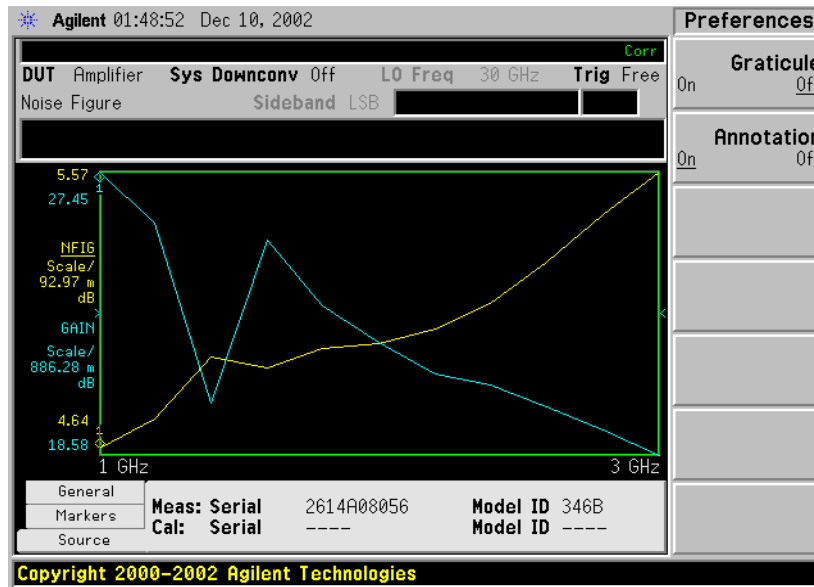

Turning the Display Annotation On or Off

When **Annotation** is set to **On**, the annotation is displayed on the screen. This is the default setting. When **Annotation** is set to **Off**, the annotation is not displayed on the screen.

To turn the annotation on or off:

- Step 1.** Press the **Display** key.
- Step 2.** Press the **Preferences** key.
- Step 3.** Press the **Annotation** key to select the **Off** or **On** as required.

Figure 2-9 Typical Graph with Annotation Switched Off

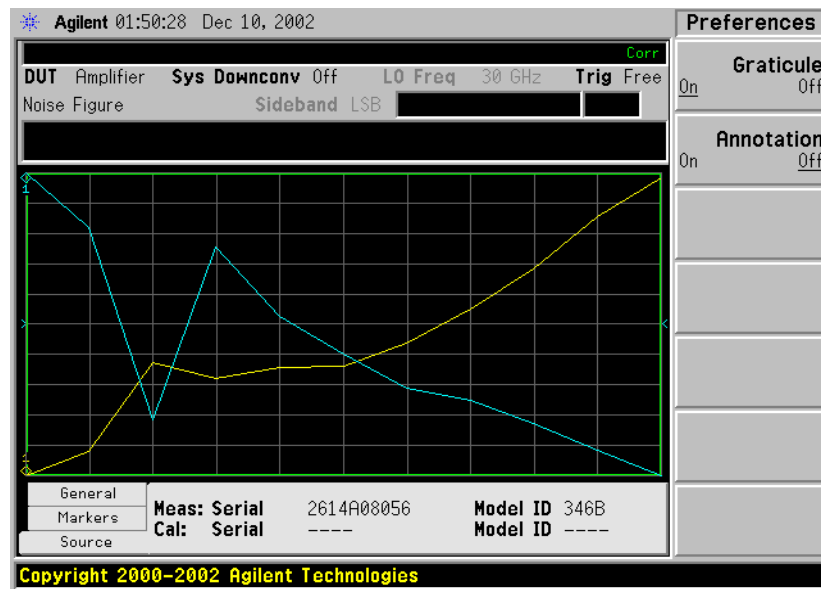

Setting the Scaling

You can set the result's scale parameters in the active graph. To set the scale, press the **Amplitude/Y Scale** key.

NOTE To change the active graph, press the **Next Window** key.

Figure 2-10 Typical Noise Figure Displayed on a Graph

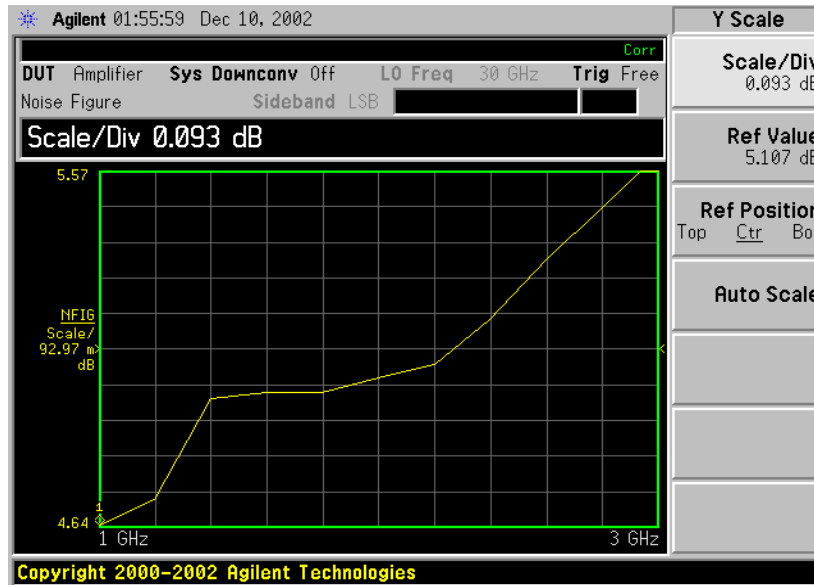

Press the **Amplitude/Y Scale** key to display the Y Scale menu. You can set the scale for the measurement display manually, or press the **Auto Scale** key. Pressing **Auto Scale** selects the optimum values for **Ref Value** and **Scale/Div**.

NOTE If limit line **Display** is set to **On**, and **Autoscale** is pressed or the scale is changed, the limit lines may no longer appear in the display.

Setting Noise Figure Scale

NOTE The following procedure can also be applied to other result types

To make Noise Figure the active screen and set up the noise figure parameters, use the following procedure.

- Step 1.** Press the **Next Window** key so that your desired graph (upper or lower) is highlighted with a green border.
- Step 2.** Press the **Trace/View** key.
- Step 3.** Press the **Result A** or the **Result B** key, depending on whether you want the Noise Figure results displayed in the upper (**Result A**) or lower (**Result B**) graph.
- Step 4.** Press the **Noise Figure** key.
- Step 5.** Press the **Noise Figure (dB)** key.

NOTE If you press the **Noise Factor (Linear)** key, the graph will display **Noise Factor** instead of Noise Figure results. Noise Factor results are displayed on a power (watts) scale.

- Step 6.** Press the **Amplitude/Y Scale** key.
- Step 7.** Press the **Scale/Div** key. Change the scale per division value using the knob or the numeric keys. Values entered using the numeric keys can be terminated by pressing the **dB** or the **linear** key.

NOTE Instead of setting the **Scale/Div** manually, you can let the analyzer choose a suitable value that will cause the measurement trace to be displayed over the full height of the display window. To do this, press the **Auto Scale** key.

Setting the Reference Level

- Step 1.** Press the **Ref Value** key. Change the reference value using the knob or the numeric keys. Values that are entered using the numeric keys can be terminated using either the **dB** key or the **linear** key. If you press the **linear** key, the figure you entered is automatically converted to dB.

Working with Markers

NOTE The marker functions only apply when you are working in graph format.

Marker functions measure the frequency and measurement results by placing a diamond-shaped marker at a point on the trace. The measurement results displayed depend on the result type selected.

The analyzer has four markers, **Marker(1)**, **Marker(2)**, **Marker(3)**, and **Marker(4)**. The markers are coupled to both the lower graph trace and upper graph trace.

Each marker can be enabled as a normal, delta, or delta pair marker. The active marker's frequency is displayed in the active function area, and at the bottom of the screen. The enabled marker's results are displayed under the **Markers** tab bar at the bottom of the screen.

NOTE The active Tab at the bottom of the screen can be changed by pressing the left-arrow and right-arrow keys

Selecting Markers

To select a marker:

Step 1. Press the **Marker** key.

Step 2. Press the **Select Marker** key to select the marker of interest.

The active marker is identified by being underlined in the **Marker** key label.

Step 3. Press the **Normal**, **Delta** or **Delta Pair** key to select your type of marker(s).

Figure 2-11 A Normal State Marker

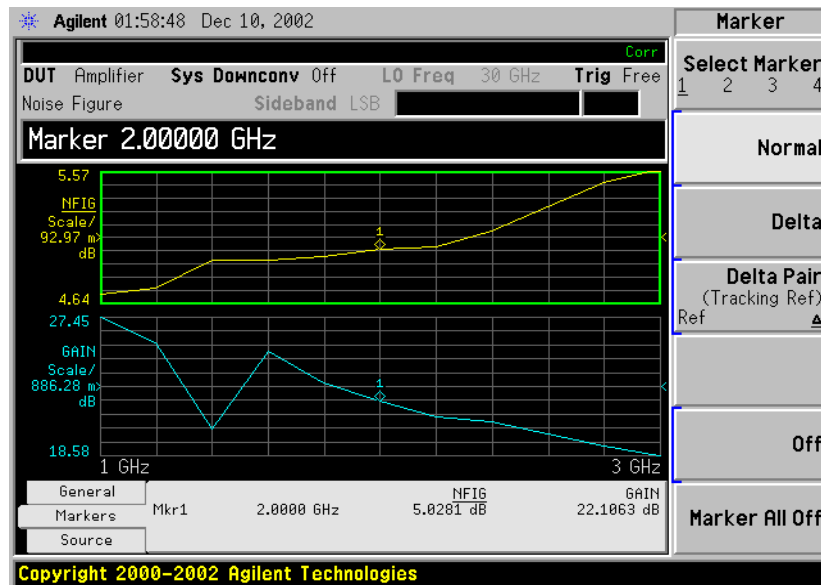

A marker is now placed on each trace. Turn the knob or use the up- and down-step keys to place the markers at the point on the trace you want to measure, or use the numeric keys to enter the frequency of interest. The marker frequency and marker result are displayed against the **Marker** tab bar which is below the graph display. Their frequency values are also displayed in the active function area.

NOTE

A marker can only be placed on a point where a measurement has been made. It is not possible to place a marker at an interpolated position on the graphs.

To turn an active marker off

To turn an active marker off, press the **Off** key. This also removes the marker annotation from the marker tab at the bottom of the screen, and the marker frequency from the active function area.

To change the active marker

The default active marker setting is **Marker(1)**. To change the active marker, press the **Select Marker** key. This moves the active marker from **Marker(1)** to **Marker(2)**. Press it again and it moves the active marker from **Marker(2)** to **Marker(3)**. This process is repeated until it returns to the **Marker(1)**.

Figure 2-12

Four Normal State Markers

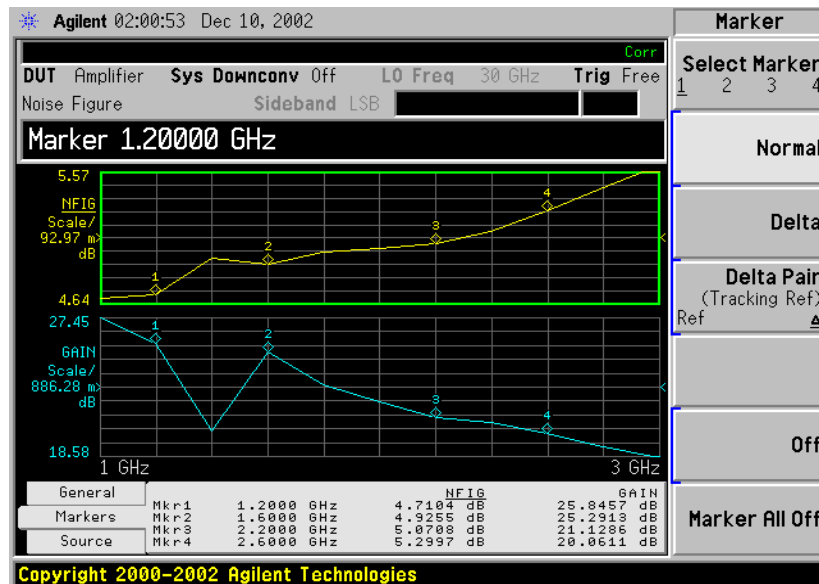

To Switch all the Markers Off

To switch all the markers off press **Marker All Off**. This turns off all the markers and associated annotation.

Changing the Marker States

To use Delta Markers

The **Delta** key places a reference marker at the current position of the active marker. The delta markers enable you to measure the difference between the reference marker and the delta marker position on the trace. Turn the knob to place the delta marker to the point on the trace you want to measure. The position of the reference marker remains fixed. The delta marker has its frequency and measurement result value differences annotated relative to the reference marker on the marker tab at the bottom of the screen. The delta marker has its actual frequency value is displayed in the active function area. See [Figure 2-13](#).

Figure 2-13 The Delta Marker State enabled



To activate a Delta marker:

- Step 1.** Press the **Marker** key.
- Step 2.** Press the **Select Marker** key to select the marker of interest.
- Step 3.** Press the **Delta** key to highlight it. Use the knob to move the Delta marker from the reference marker. The annotation on the marker tab at the bottom of the screen displays the difference between the reference marker and the delta marker. The frequency of the delta marker is displayed in the active function area at the top of the screen.

To use Delta Pair Markers

The **Delta Pair** key places two markers allowing you to choose to move either the normal marker or the reference marker. This feature is similar to the **Delta** marker, except you can choose to move either the reference or the delta marker.

When you first select a marker as a Delta Pair, the active marker is the reference marker. **Ref** will be underlined on the **Delta Pair** key to indicate this. The reference marker is indicated by the letter 'R' beside the

marker's number on the display. Once you have positioned the reference marker, press the Delta Pair key again to underline the delta marker (Δ). Your delta marker is now the active marker. You can position this on any of the measurement points on the graph by using the knob, the step-up or the step-down keys, or the numeric keys. The position of the reference marker remains fixed until the reference marker is re-activated by pressing the Delta Pair key again. The active marker has its frequency and measurement result value differences annotated below the graph. Its actual frequency value is displayed in the active function area. See [Figure 2-14](#).

Figure 2-14 Delta Pair with Reference Marker Enabled

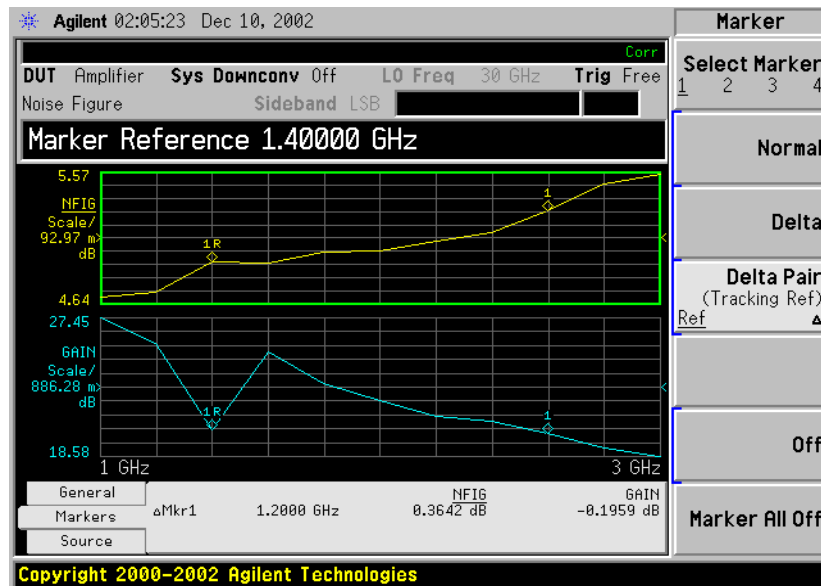

To activate the Delta Pair markers:

- Step 1.** Press the **Marker** key.
- Step 2.** Press the **Select Marker** key to select the marker of interest.
- Step 3.** Press the **Delta Pair** key to highlight it. Make sure that **Ref** is underlined on the **Delta Pair** key.
- Step 4.** Use the knob, or the step-up or step-down keys, to move the reference marker to the required position on the traces.
- Step 5.** Pressing the **Delta Pair** key again fixes the position of the reference marker, and allows you to move the reference marker using the knob, the step-up or step-down keys, or the numeric keys.

Figure 2-15 Delta Pair with Delta Marker Enabled



Searching with Markers

The **Peak Search** key accesses a further menu which allows you to place an active marker on the minimum or maximum points of a trace when using a Normal marker. When using Delta or Delta Pair markers, you can search for the Minimum Peak to Maximum Peak on the trace. You can set these to repeat continuously, or by manually pressing the **Find** key as required.

It should be noted that the Search function operates on the active trace. The active trace is always indicated by underlining of the name of the measurement, for example, the NFIG measurement shown in [Figure 2-16 on page 77](#). When two measurements are shown in two separate windows on the display, that is, when **Combined** is set to **Off**, the active trace is also indicated by a green border surrounding the graph. This is also shown with the NFIG measurement in [Figure 2-16 on page 77](#).

The marker on the second trace, that is, the marker on the inactive trace, is positioned at the same frequency position as the marker on the active trace.

Searching for Min or Max point

You need to have activated a Normal marker to perform a minimum or maximum search.

Figure 2-16 Typical Trace showing Maximum Point Found

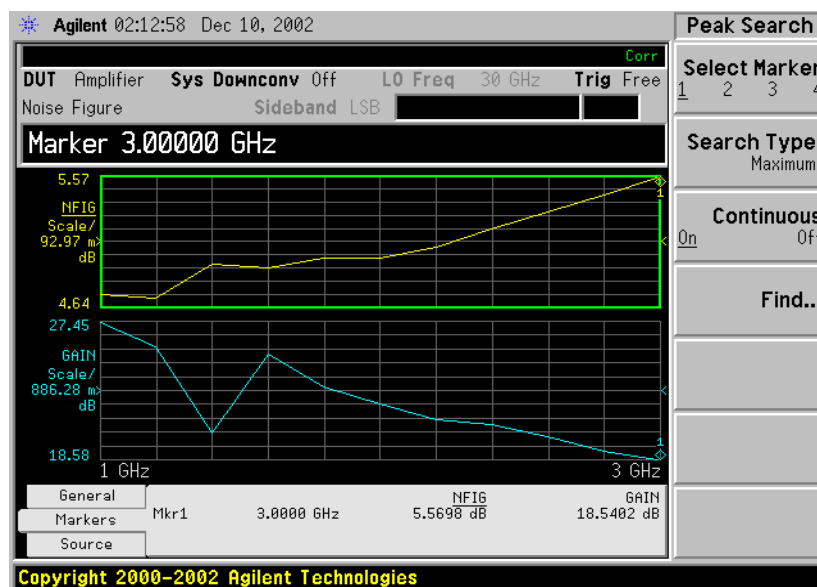

To search for the maximum point:

- Step 1.** Press the **Peak Search** key.
- Step 2.** Press the **Search Type** key to select the **Maximum**.
- Step 3.** Press the **Find** key.

The marker is now placed at the maximum point of the active trace.

If you want to continuously find the maximum point on the trace, set

Continuous to **On**.

Searching for Peak to Peak points

You need to have activated Delta or Delta Pair markers to perform a Peak to Peak search.

Figure 2-17 Peak to Peak Found



Step 1. Press the **Peak Search** key.

Step 2. Press the **Search Type** key to select **Pk-Pk**.

Step 3. Press the **Find** key.

The markers are now on the maximum and minimum points of the trace.

If you want to continuously find the maximum and minimum points on the trace, set **Continuous** to **On**.

The annotation displays the difference between the two points.

Indicating an Invalid Result

When an invalid result is detected while in graph display format, the graph is drawn at the top of the screen for the current measurement point and a special marker indicator is displayed. Also in table and meter formats the same special indicators are used to display an invalid result.

Several invalid result conditions may exist simultaneously. These conditions are ranked in order of severity and only the most severe condition present is displayed.

The ranking order is:

Table 2-4

Ranking Order of Invalid Result Conditions

Ranking Order	Invalid Result Condition	Marker Indicator
1	Hot power \leq cold power	"=="
2	Corrected calculation not possible	"XX"
3	Measurement result calculation invalid	"--"

The ranked order 2 only occurs if a corrected measurement is requested and either:

- The input range used at this measurement point is not calibrated.
- The input range is calibrated, but the calibration data is invalid at this point.

Example of a Basic Amplifier Measurement

Noise figure measurements are made by measuring the output power of the DUT for two different input noise power levels. The high and low power inputs come from a calibrated noise source. The noise source is switched on and off in rapid succession. High power input to the analyzer uses the noise power generated when the noise source is switched on, and low power input uses the noise power generated at ambient temperature with the noise source switched off.

This section uses a DUT to show how a basic noise figure measurement and various basic operations are performed. The DUT used is a low noise amplifier with a usable frequency range of 20 MHz to 3.0 GHz. The specifications of interest to the example are listed in [Table 2-5](#).

Table 2-5

The Example DUT Specifications

Frequency Range	Typical Gain	Minimum Gain	Typical Noise Figure
20 MHz to 3 GHz	20 dB	14 dB	4.8 dB

The example sets a frequency range of interest of 1.0 GHz to 2.0 GHz. The purpose of the measurement is to verify the specified table results are as stated over the frequency range of interest.

When you are making measurements, follow the procedure and change the values to meet your needs.

NOTE

For these basic measurements confirm the analyzer **Meas Mode** is in the default setting. This status is displayed above the graphs as follows:

- **DUT:** Amplifier
- **Sys Downconv:** Off

Calibrating the Noise Figure Analyzer

The first step is to calibrate the analyzer to obtain the corrected measurement you wish to make.

Step 1. Turn the instrument on and wait for the power-up process to complete.

NOTE

To obtain greater accuracy, it is recommended the analyzer warm up for at least one hour with **Alignment, Auto Align** set to **On**.

Step 2. Press **System, Power On/Presets, Preset Type** set to **Mode** and press the green **Presets** key to return the analyzer to its factory-default state.

Step 3. Press the **Mode** key and set the measurement mode to **Noise Figure**.

Step 4. Press the **Measure** key and set the measurement to **Noise Figure**.

Step 5. Press **Meas Setup, ENR**, and set **ENR Mode** to **Table**.

Step 6. On the same menu, press **Common Table** and set it to **On**.

Step 7. Again on the same menu, press **Meas & Cal Table...** to enter the ENR values of the noise source.

In this example, a 346B noise source is used which has the following Frequency/ENR pairs up to 2 GHz (covering the required frequency range of 1.0 GHz to 2.0 GHz):

Table 2-6 Example Noise Source ENR/Frequency values

Frequency (GHz)	ENR (dB)
.01	15.13
.10	15.39
1.0	15.21
2.0	15.02

Step 8. Press the **Frequency/Channel** key to set the frequency parameters of the measurement:

- **Freq Mode** — Sweep
- **Start Freq** — 1.0 GHz
- **Stop Freq** — 2.0 GHz
- **Points** — 15

Step 9. Press the **Meas Setup** key to set the averaging you want.

This example uses the following settings:

- **Averaging** — On
- **Averages** — 5

Step 10. Press the **BW/Avg** key to set the resolution bandwidth you want.

This example uses the following settings:

- **Bandwidth** — 1 MHz, Auto

Step 11. Press the **Input/Output** key, the **Noise Figure Corrections** key and the **Input Cal** key to change the minimum and maximum input attenuation, if required.

This example, made on a PSA Series analyzer, uses the default minimum input attenuation of **0 dB**, and the default maximum input attenuation of **8 dB**.

Step 12. Connect the noise source input to the Noise Source Output port on the rear of the analyzer using the appropriate cable, and connect the noise source output to the **RF INPUT 50 Ω** port as shown in [Figure 2-18](#).

Figure 2-18 ESA Calibration Setup with Normal or Smart Noise Sources

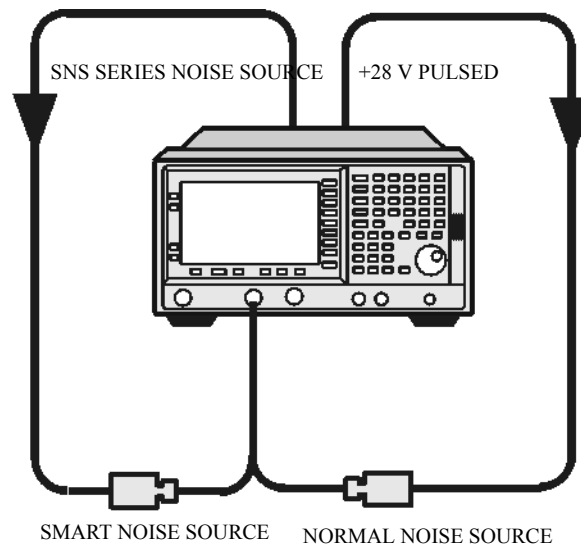

Step 13. Press the **Meas Setup** key and the **Calibrate** key twice to calibrate the analyzer.

A graph similar to [Figure 2-19](#) is now displayed.

With calibration completed and no device under test inserted, both gain and noise figure with **Corrected** set to **On** are near 0 dB. This shows that the analyzer has removed the noise contribution from the measurement system. Since the input is noise, which is random in its nature, there is some variation above and below zero.

NOTE

Measurement performance > 3 GHz is not specified. If you do not have a preamp and you are calibrating above 3 GHz, the calibration data will

vary significantly. Measurements made with this calibration data might be valid, but only if the device you are testing has a high enough gain and noise figure, such that the sum of these is about 35 dB or more. Otherwise, the measurement accuracy will be poor.

Figure 2-19 Typical Graph after calibration is complete

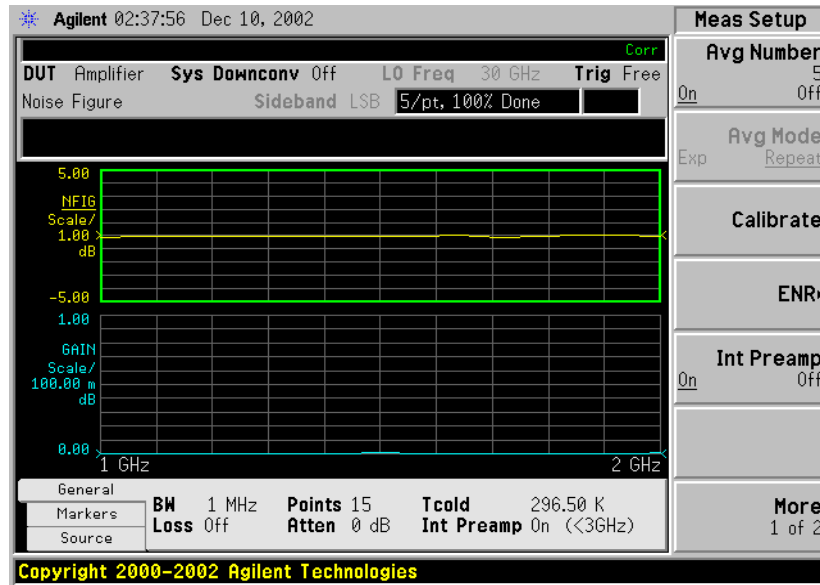

Press the **Trace/View** key to select **Table**. A result similar to [Figure 2-20](#) is now displayed. The expectation is approximately 0 dB of noise figure and gain. It may be better to view these results using table format mode.

Figure 2-20 Typical Tabulated Results after Calibration

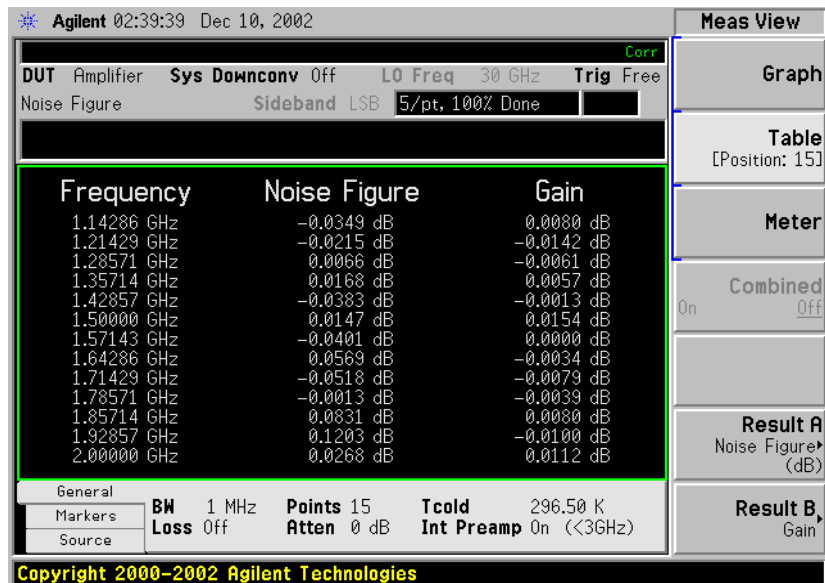

Making Measurements

To make noise figure measurements once calibration is complete:

- Step 1.** Disconnect the noise source from the 50Ω input of the analyzer
- Step 2.** Connect the DUT to the 50Ω input of the analyzer.
- Step 3.** Connect the noise source output to the DUT input as shown in [Figure 2-21](#).

Figure 2-21 Connecting the DUT to make a measurement on an ESA

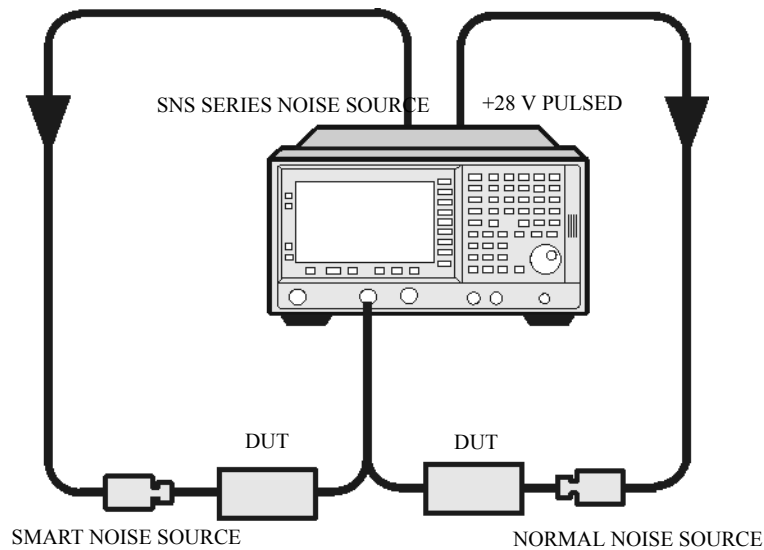

After the DUT and noise source are connected, the measurement result appears on the analyzer's display. If it does not, press **Restart**. If you want to get a continuous update, ensure **Sweep** is set to **Cont**. This is located under the **Sweep** key menu. This is the default setting.

A result similar to [Figure 2-22](#) is now displayed.

Figure 2-22 Typical Tabulated Results after Measurement

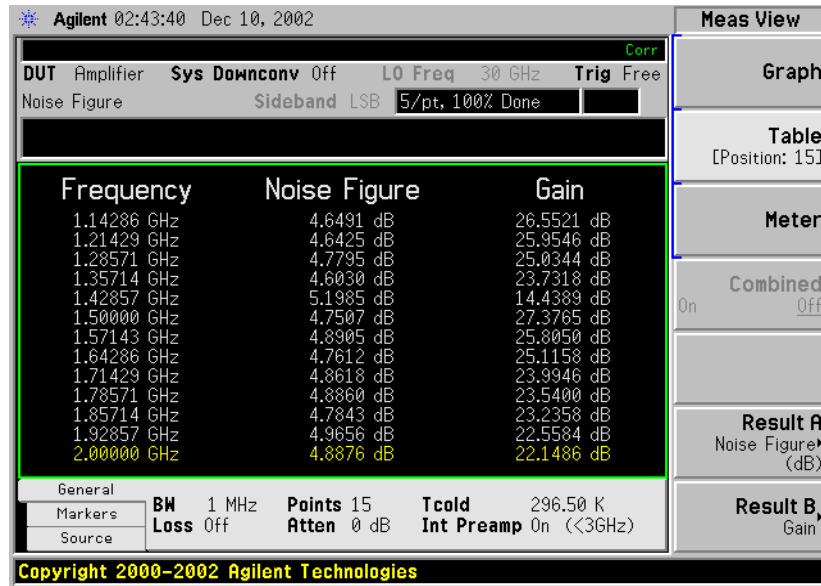

Step 4. Press the **Trace/View** key and select **Graph**. A graphical result similar to [Figure 2-23](#) is now displayed.

Figure 2-23 Typical Graphical Results after Measurement

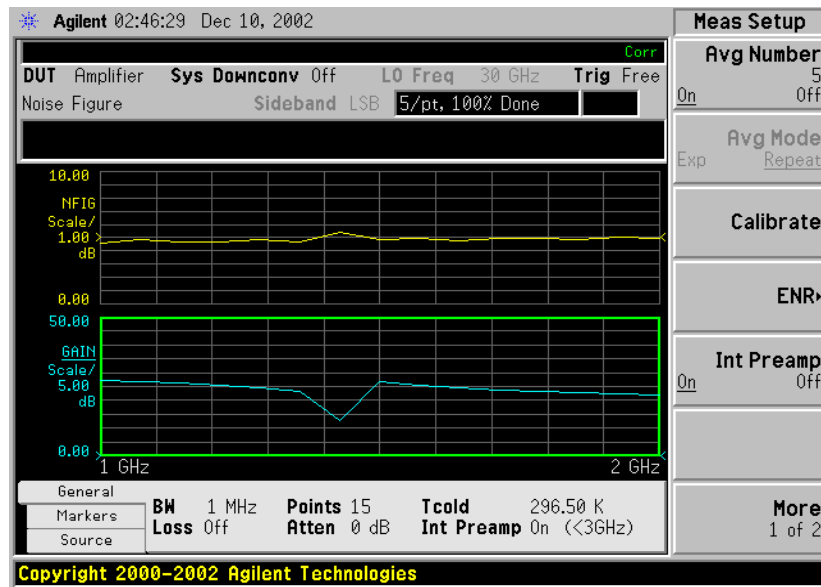

The results shown in [Figure 2-22](#) and [Figure 2-23](#) shows the DUT has an average noise figure of 4.8 dB, an average gain of 23 dB and a minimum gain of 14.4389 dB. The device under test therefore meets its manufacturer’s specification over the frequency range of interest.

Further Information on Noise Figure Measurements

Agilent Technologies produces three application notes about noise figures and their measurement. These are:

- *Application Note 57-1*
Fundamentals of RF and Microwave Noise Figure Measurements
- *Application Note 57-2*
Noise Figure Measurement Accuracy - the Y-Factor Method
- *Application Note 57-3*
10 Hints for Making Successful Noise Figure Measurements

All three application notes are available from the Agilent website at <http://www.agilent.com/find/esa>

3 **Advanced Features**

This chapter describes how to use the Limit Lines and Loss Compensation features on your Noise Figure Analyzer. There is a section on how to use the Preselector Adjust function to increase the accuracy of your results, and a section on how to use the Noise Figure Uncertainty Calculator.

What You will Find in this Chapter

This chapter covers:

- [Setting up Limit Lines](#) and using them for pass/fail testing of the measurements.
- [Using Loss Compensation](#) and using this to correct for system losses in cabling, switches, or connectors and system components.
- [Adjusting the Preselector](#) and using this to enhance the accuracy of your measurements above 10 GHz.
- [Noise Figure Uncertainty Calculator](#) and how to use it.

Setting up Limit Lines

Limit lines can be set to mark lower or upper boundaries of the active traces and they can also be set to notify you of a failure when a trace passes over a limit line. Two limit lines can be applied to a single trace, for example, allowing an upper and lower boundary limit to be specified.

The Noise Figure application (Option 219) features four independent Limit Lines. The **Limit Line (1)** and **Limit Line (2)** are applied to the upper graph, and **Limit Line (3)** and **Limit Line (4)** are associated with the lower graph.

To change the Limit Line

The default limit line setting is **Limit Line (1)**. To change the active indicator, press the **Limit Line** key. This moves the active indicator from **Limit Line (1)** to **Limit Line (2)**, press it again and it moves the active indicator from **Limit Line (2)** to **Limit Line (3)**. This process is repeated until it returns to the **Limit Line (1)**.

Setting the Type of Limit Line

You can set the Limit Line to be an upper limit or lower limit and test the trace against this limit line setting.

To set the limit line type, select your Limit Line, then press **Edit** to display the Limit Line form, and set **Type** to **Upper** if you want it to be above the trace or **Lower** if you want it to be below the trace. Each of the four limit line needs to be set up separately.

Enabling Testing against a Limit Line

You can set the Limit Line to test against the trace. If a result fails testing it is reported in the upper right hand corner of the display. In table mode you also see the reported result failure.

To set the testing of the trace against the limit line, set **Test** to **On** if you want the result reported or set **Test** to **Off** if you do not want the result reported. Each of the four limit lines needs to be set up separately.

NOTE After a failure the LIMITS FAIL: indicator remains displayed until:

- a complete sweep has been performed with the Limit Line test passing at every point
- you switch **Test** to **Off**
- you change the limit line type
- you press **Restart**

To Display a Limit Line

You can choose to display a Limit Line.

To display the limit line on the graph, set **Display** to **On**. To not display the limit line on the graph, set **Display** to **Off**. Each of the four limit lines needs to be set up separately.

To Switch all the Limit Lines Off

To switch all the Limit Lines off, press **Disable All Limits**. This simultaneously switches off all Limit Lines, regardless of what graph or trace they are associated with. Both **Test** and **Display** settings remain unaffected.

NOTE When a limit line is switched off, the limit line data is not affected.

Creating a Limit Line

To set up limit lines, you need to specify the frequencies, the Y-axis value, and whether or not it is to be connected to the previous limit line point. The limit line consists of a table of entries, each of which is a frequency-limit-connected group.

The **Limit** or Y-axis value is a dimensionless unit, hence you need to know what Y-axis scale you are working in before you set this.

NOTE

When you change the result parameter, the **Limit** or Y-axis values are not converted. This is due to the value being dimensionless.

To create a limit line:

Step 1. Press the **Display** key, then the **Limit Lines** key and select the limit line you want to create.

Step 2. Press the **Edit...** key.

You are presented with a Limit Line table with two entries. These two entries are at frequencies of 10 Hz and 26.5 GHz, that is, at the minimum and maximum extremities of the Noise Figure Measurement personality's frequency range.

Figure 3-1

Limit Line Table before Limit Lines Values are Added

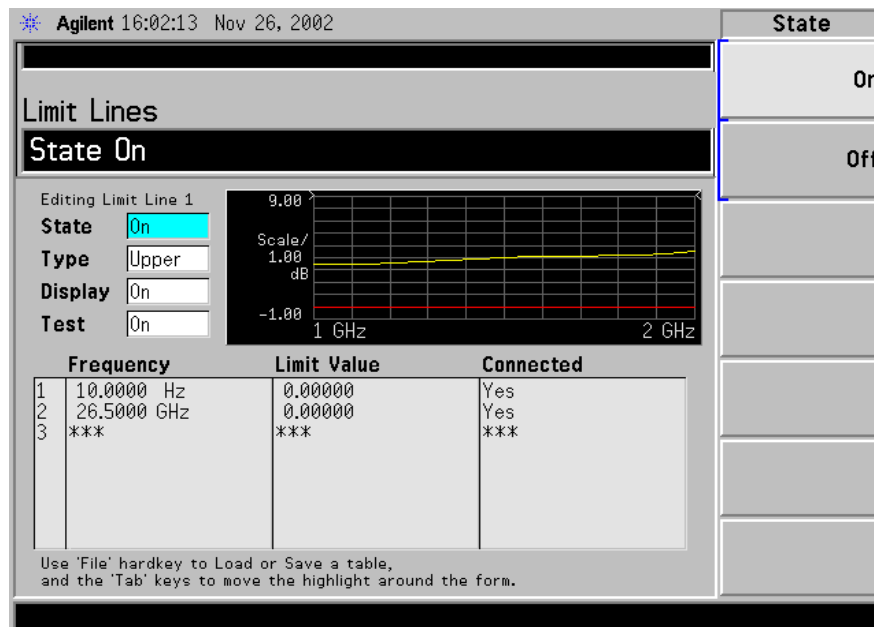

Step 3. Set the **State** to **On** to display the limit line.

Step 4. Tab down to the **Type** field, and set your line type. When you set **Type** to **Upper**, any limit line test is deemed to have failed if the trace goes above the line. If you set **Type** to **Lower**, any limit line test is deemed to have failed if the trace falls below this limit line.

Advanced Features

Setting up Limit Lines

- Step 5.** Tab down to the **Display** field, and set **Display** to **On** to display your limit line
- Step 6.** Tab down to the **Test** field. Set **Test** to **On** to test the trace against the limit line. Set **Test** to **Off** to omit the test.
- Step 7.** Tab down to the first Frequency value (or to the first empty frequency field if you wish to keep the existing frequency values) and enter the frequency using the numeric front panel keys. Finish by pressing the unit of measurement terminator key.
- Step 8.** Enter the **Limit** or Y-axis unit value corresponding the frequency you just entered. Again, finish by pressing the unit of measure terminator key.
- A limit line unit value to be useful is derived from the scale values you are using to display the trace.
- Step 9.** Set **Connected** to **Yes** or **No**. When **Connected** is set to **Yes** it connects that point to the previous point to form a continuous line. To disconnect a point, set **Connected** to **No**, this disconnects it from the previous point. [Figure 3-2](#) shows the connections and [Figure 3-3](#) shows the graphical result with limit line **Display** set to **On**.

NOTE

When the Limit Line Test is set to **On**, and a trace crosses over the limit line, the test is only performed between connected points. Also, if you are making a fixed frequency measurement, you only need to specify that frequency value. The limit line will be tested on that single point.

- Step 10.** Repeat this process until the limit line is defined. Limit line tables can have a maximum of 101 entries.

The limit line is now defined. Press the **Return** key to return to the limit line menu. When saving a limit line table you need to specify the limit line number to which the table applies.

NOTE

You can load a previously saved Limit Line table. However, you need to specify which limit line number you want loaded. See the *PSA Series Spectrum Analyzers User's and Programmer's Reference Guide*, or the *ESA User's/Programmer's Reference* for more details on loading a file.

Figure 3-2 Typical Limit Line Connections in Table

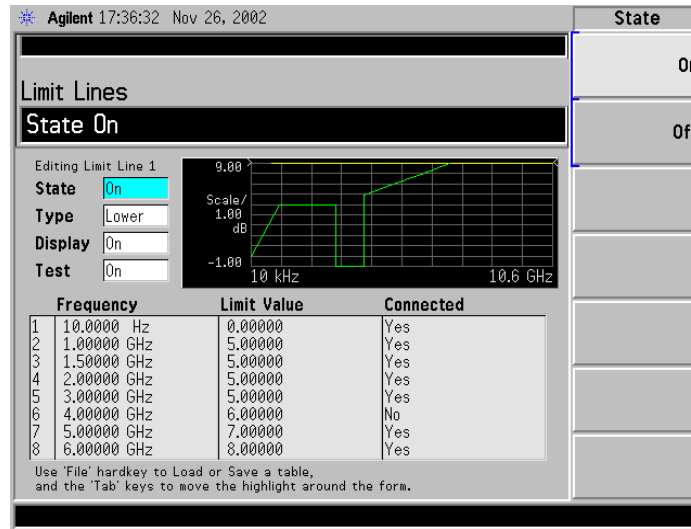
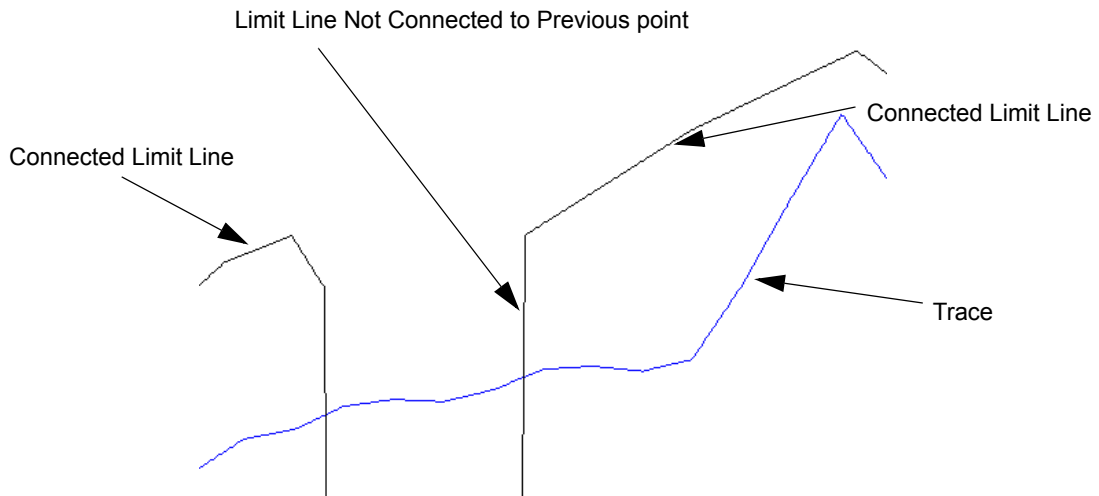

Figure 3-3 Limit Line Connections Displayed



Using Loss Compensation

You can configure the Noise Figure application (Option 219) to compensate for losses due to cabling and connectors, and those due to temperature effects that occur in the measurement setup. These can be between the Noise Source and the DUT (**Before DUT**), or between the DUT and the analyzer input (**After DUT**), or both. Loss compensation can be set either by specifying a single, fixed loss value which gets applied at all frequencies, or using various loss values, specified in a table, applied across the frequency span. In the table mode, linearly interpolated values are used between each table entry.

Any device that causes loss will also generate excess noise, and this excess noise is proportional to the absolute temperature of the device causing the loss. You can compensate for this extra noise by specifying the temperature of the device causing the loss. This temperature dependent compensation is applied at all frequencies.

Examples where Loss Compensation is applied

This is important in cases such as:

1. Amplifiers with waveguide input, where a lossy waveguide-to-coax adapter is needed.
2. Transistors, where input and output tuners are required.
3. Non-50W converters (such as TV tuners and amplifiers) where matching pads or transformers are required.
4. Compensation for fixed attenuators used to improve SWR.
5. Double sideband measurement modification (of receivers and mixers) to approximate single sideband results.

Configuring Fixed Loss Compensation

To configure fixed loss compensation follow the example below:

- Step 1.** Press the **Input/Output** key.
- Step 2.** Press the **Loss Comp** key.
- Step 3.** Press the **Setup...** key to access the **Loss Compensation Setup** form, see [Figure 3-4](#)

Figure 3-4 Typical Limit Line Connections in Table

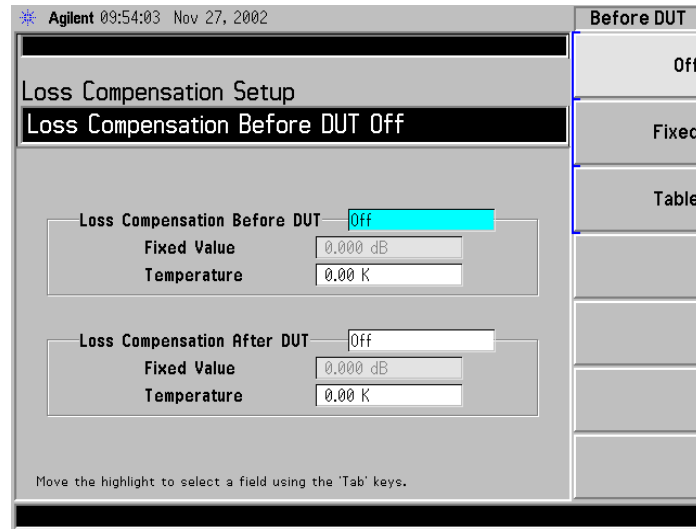

Step 4. When configuring loss compensation before the DUT, use the **Tab** key to navigate to the **Loss Compensation Before DUT** field and set **Loss Compensation Before DUT** to **Fixed** by selecting the **Fixed** key to highlight it.

NOTE

A fixed loss compensation value cannot be entered or changed if the **Before DUT** field or the **After DUT** field is not set to **Fixed**. It is selected by highlighting the **Fixed** key.

Step 5. To set the loss compensation value before the DUT, use the **Tab** key to navigate to the **Fixed Value** field and input the required value for the loss occurring before the DUT, see [Figure 3-5](#).

Enter a value using the numerical keypad and terminate it using the unit keys presented to you which are either **Linear** or **dB**.

The lower limit is -100.000 dB, the upper limit is 100.000 dB, and the default is 0.000 dB.

Step 6. Use the **Tab** key to navigate to the **Temperature** field, and use the numeric keys or the knob to enter the temperature of the device where the loss is occurring. This will normally be room temperature, which is 296.5 K.

NOTE

It is important that you enter the correct temperature. Leaving the **Temperature** set to the default value of 0.00 K will result in incorrect noise figure measurements.

Step 7. When configuring loss compensation after the DUT, use the **Tab** key to navigate to the **Loss Compensation After DUT** field and set **Loss Compensation After DUT** to **Fixed** by selecting the **Fixed** key to highlight

Advanced Features

Using Loss Compensation

it, see [Figure 3-5](#).

- Step 8.** To set the loss compensation value after the DUT, use the **Tab** key to navigate to the **Fixed Value** field and input the required value for the loss occurring after the DUT.

Enter a value using the numerical keypad and terminate it using the unit keys presented to you which are either **Linear** or **dB**.

The lower limit is -100.000 dB, the upper limit is 100.000 dB and the default is 0.000 dB.

- Step 9.** Use the **Tab** key to navigate to the **Temperature** field, and use the numeric keys or the knob to enter the temperature of the device where the loss is occurring. This will normally be room temperature, which is 296.5 K.

NOTE

It is important that you enter the correct temperature. Leaving the **Temperature** set to the default value of 0.00 K will result in incorrect noise figure measurements.

Figure 3-5 Loss Compensation Setup Form with Fixed Selected

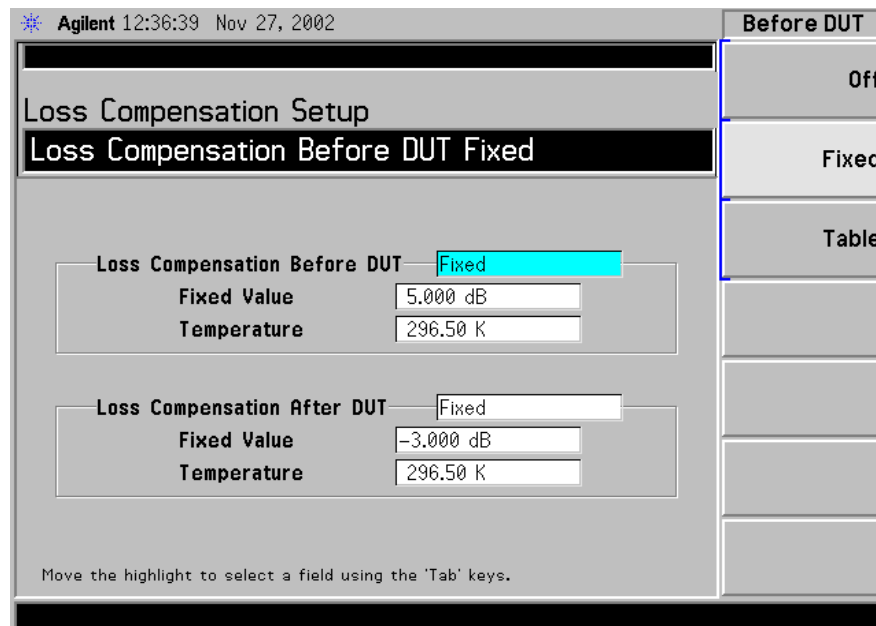

Agilent 12:36:39 Nov 27, 2002

Loss Compensation Setup

Loss Compensation Before DUT Fixed

Loss Compensation Before DUT Fixed

Fixed Value 5.000 dB

Temperature 296.50 K

Loss Compensation After DUT Fixed

Fixed Value -3.000 dB

Temperature 296.50 K

Move the highlight to select a field using the 'Tab' keys.

Before DUT

Off

Fixed

Table

Configuring Table Loss Compensation

To configure table loss compensation proceed as follows.

- Step 1.** Press the **Input/Output** key.
- Step 2.** Press the **Loss Comp** key
- Step 3.** Press the **Setup...** key to access the **Loss Compensation Setup** form, see [Figure 3-6](#).

Figure 3-6 Loss Compensation Setup Form

The screenshot shows the 'Loss Compensation Setup' form. At the top, it says 'Agilent 09:54:03 Nov 27, 2002'. The main title is 'Loss Compensation Setup'. Below that, it says 'Loss Compensation Before DUT Off'. There are two main sections. The first is 'Loss Compensation Before DUT' with a dropdown menu set to 'Off'. Below this are fields for 'Fixed Value' (0.000 dB) and 'Temperature' (0.00 K). The second section is 'Loss Compensation After DUT' also with a dropdown menu set to 'Off', and fields for 'Fixed Value' (0.000 dB) and 'Temperature' (0.00 K). On the right side, there is a vertical menu with options 'Off', 'Fixed', and 'Table'. The 'Table' option is highlighted. At the bottom, there is a note: 'Move the highlight to select a field using the 'Tab' keys.'

- Step 4.** When configuring table loss compensation before the DUT, use the **Tab** key to navigate to the **Loss Compensation Before DUT** field and select the **Table** key to highlight it, see [Figure 3-7](#).

The table loss compensation used is as specified in the Loss Compensation Before DUT Table. See [“Creating a Loss Compensation Table” on page 99](#).

- Step 5.** Use the Tab key to navigate to the Temperature field, and enter the temperature of the devices which are causing the loss. Room temperature requires a value of 296.5 K.

NOTE

It is important that you enter the correct temperature. Leaving the **Temperature** set to the default value of 0.00K will result in incorrect noise figure measurements.

- Step 6.** When configuring table loss compensation after the DUT, use the **Tab** key to navigate to the **Loss Compensation After DUT** field and select the **Table** key to highlight it, see [Figure 3-7](#).

Advanced Features

Using Loss Compensation

The table loss compensation used is as specified in the Loss Compensation After DUT Table. See “Creating a Loss Compensation Table” on page 99.

Figure 3-7 Loss Compensation Setup Form with Table Selected

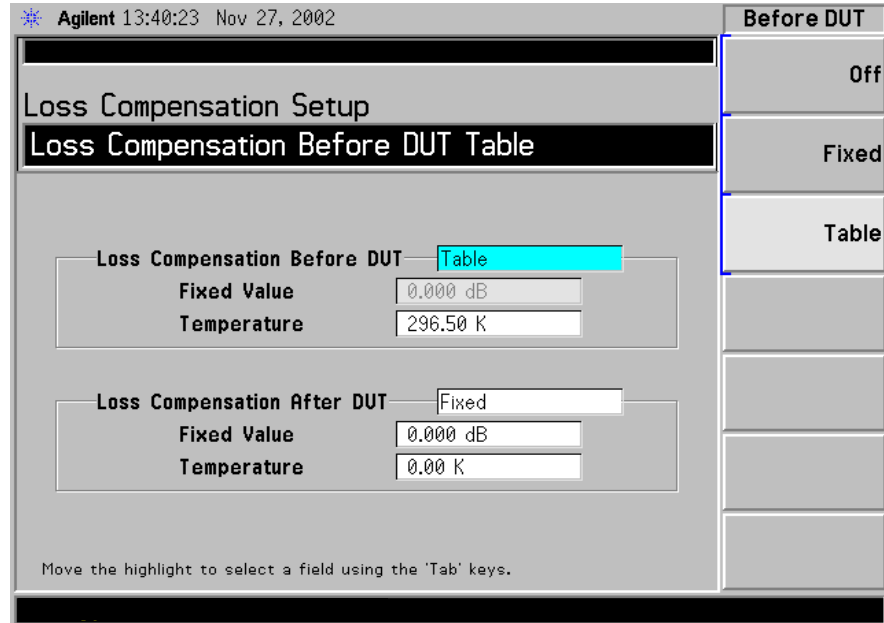

Agilent 13:40:23 Nov 27, 2002

Loss Compensation Setup

Loss Compensation Before DUT Table

Loss Compensation Before DUT **Table**

Fixed Value 0.000 dB

Temperature 296.50 K

Loss Compensation After DUT Fixed

Fixed Value 0.000 dB

Temperature 0.00 K

Before DUT

Off

Fixed

Table

Move the highlight to select a field using the 'Tab' keys.

NOTE

You can load a previously saved Loss Compensation table. However, you need to specify whether the Loss Compensation table is an **After Table** or a **Before Table**. See the *ESA User's / Programmer's Reference* for more details on loading a file.

Creating a Loss Compensation Table

Loss Compensation tables can have a maximum of 401 entries. To create a loss compensation table proceed as follows.

- NOTE** The example shows how to enter a Before DUT Table. If you want to enter an After DUT Table follow the procedure, changing the **Before DUT Table...** key presses to **After DUT Table...** key presses.
- NOTE** If you want to enter new loss compensation data and there is previous loss compensation data in the Noise Figure application (Option 219), you can delete the previous data by pressing the **Delete All** key. An empty table is shown in [Figure 3-8](#).
- NOTE** The Loss Compensation table frequency limits in the **Before DUT Table...** are specified in terms of the DUT's input frequencies and the **After DUT Table...** are specified in terms of the DUT's output frequencies. This is important when making frequency converting DUT measurements or using a system downconverter.

Step 1. Press the **Input/Output** key.

Step 2. Press the **Loss Comp** key, and the **Before DUT Table...** key.

A **Loss Compensation Before DUT Table** appears on the display with the first loss frequency point in the table highlighted, see [Figure 3-8](#). The table editing and navigation menu items now appear. For details on working with tables, see the *ESA User's / Programmer's Reference*.

Figure 3-8 An Empty Loss Compensation Table

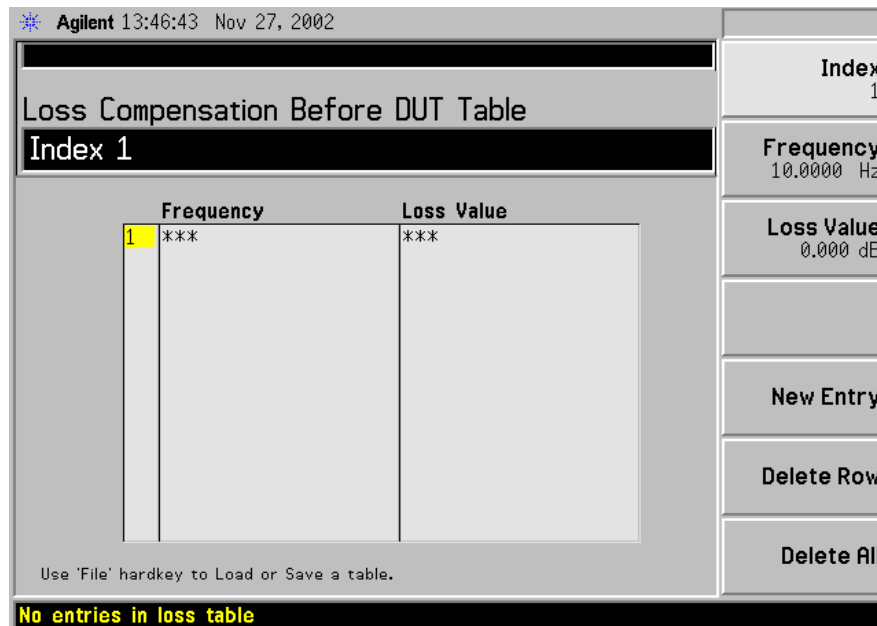

Advanced Features
Using Loss Compensation

- Step 3.** To enter or amend the first row of compensation data, press the **Tab** key to move to the Frequency column. To amend a different row in an existing table, enter the required row number using the numeric keys, and then press the **Index** key. This will highlight the index number of the required row. Now **Tab** to the Frequency column.
- Step 4.** Enter the Loss Frequency value in the table using the numeric keys. Terminate it using the unit menu keys.
- Step 5.** Press the **Tab** key to move the highlight to the Loss Value column and enter the corresponding Loss Value.
- When terminating the Loss Value you can use either **dB** or **linear** keys. However, the result always appears in the table in dB.
- Step 6.** Press the **Tab** key to move the highlight to the Loss Frequency column and enter the next Loss Frequency Value.
- Step 7.** Repeat steps 4 to 6 until all the Loss Frequency and Loss Values you need are entered.
- Step 8.** After completing the Loss Compensation table entries, press the **Return** key or **ESC** key to return to the Loss Compensation menu.
- Step 9.** Once you have completed entering the Loss Compensation data, save the Loss Compensation table using the **File** key.

See the *ESA User's/Programmer's Reference*, for more details on loading and saving a file.

NOTE You can insert the Loss Frequency/Loss Values in the Loss Compensation Table entry in any order, as the Noise Figure application (Option 219) automatically sorts the table list into ascending frequency order.

NOTE If you do not save the Loss Compensation table, you may lose the data. The data can be saved either by saving the instrument state (**File, Save, Type, State**) or by saving the table itself (**File, Save, Type, Loss Comp Before DUT**).

NOTE The Loss Compensation Table data is stored in CSV (Comma Separated Value) format. It is sometimes more convenient to use a text editor on a PC to edit or enter this data rather than to enter the data manually using the analyzer. Start by saving a table with at least one loss compensation value to diskette, and then edit or add to the saved file using your PC.

Setting Temperature of Loss

Any device (cables, connectors and so forth) that causes a loss will also generate excess noise. The amount of excess noise so generated is proportional to the absolute temperature of the device causing the loss. You must compensate for this excess noise in the measurement, and this is done by specifying the temperature of the device. To set the temperature of the device causing the loss, proceed as follows:

NOTE

The temperature you specify here is used both for **Fixed** loss compensation, and for all frequencies specified in a loss compensation **Table**.

Step 1. Press the **Input/Output** key.

Step 2. Press the **Loss Comp** key

Step 3. Press the **Setup...** key to access the **Loss Compensation Setup** form, see [Figure 3-9](#).

Step 4. To set the temperature value before the DUT, use the **Tab** key to navigate to the **Temperature** field and input the required temperature of loss value occurring before the DUT.

Enter a value using the numeric keypad and terminate it using the unit keys presented to you, either in degrees **K**, **C** or **F**. Entries terminated using the **C** or **F** keys are converted to **K**.

The lower limit is 0.0 K, the upper limit is 29,650,000.0 K. The default is 0.0 K.

Step 5. To set the temperature value after the DUT, use the **Tab** key to navigate to the **Temperature** field and input the required temperature of loss value occurring after the DUT.

Enter a value using the numerical keypad and terminate it using the unit keys presented to you, either in degrees **K**, **C** or **F**. Entries terminated using the **C** or **F** keys are converted to **K**.

The lower limit is 0.0 K, the upper limit is 29,650,000.0 K. The default is 0.0 K. Room temperature is usually given as 296.5 K.

Figure 3-9 Loss Compensation Setup Form with Temperature Selected

Agilent 14:23:27 Nov 27, 2002

Loss Compensation Setup
Temperature 296.50 K

Before Temp
296.50 K

Loss Compensation Before DUT: Table
Fixed Value: 0.000 dB
Temperature: 296.50 K

Loss Compensation After DUT: Off
Fixed Value: 0.000 dB
Temperature: 0.00 K

Move the highlight to select a field using the 'Tab' keys.

Before Temp
Before Temp 296.50 K

Adjusting the Preselector

The **Presel Adjust** feature allows you to manually adjust the center of the preselector. Correctly centering the preselector removes the possibility of your measurement frequency falling outside the passband for the preselector filter as this would reduce the accuracy of your results. This feature gives you the ability to make more accurate measurements above 10 GHz.

By changing the Presel Adjust, the center of the preselector filter can be moved. The noise figure result at your measured frequency changes with the frequency response of the preselector filter.

The procedure used to center the preselector is to monitor the noise figure value as the presel adjust sweeps its frequency within a band from -250 MHz to +250 MHz.

As shown in [Figure 3-10](#) the preselector may have more than one peak. The objective is to center the preselector in the middle and not at a peak, as a peak may be near a skirt edge. This may cause problems at other frequencies other than the frequency on which the preselector is centered. You therefore need to find the Lower Presel Skirt and Upper Presel Skirt positions in terms of the offset preselector adjustment frequencies (see [Figure 3-10](#)) and take the mean value of the two points as the preselector center.

NOTE The Y-Factor for centering the preselector at the critical frequency should ideally be greater than 0.2 dB for the procedure to be implemented effectively. This can be made with or without the DUT.

Figure 3-10 Preselector Filter Response being varied to find Optimum Frequency

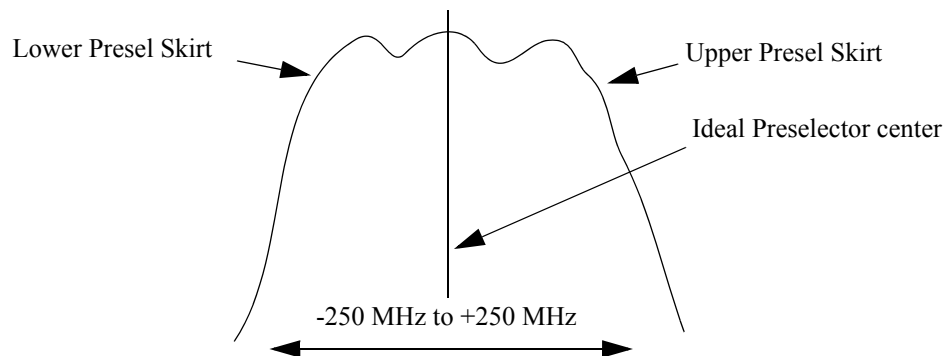

How to Manually Center the Preselector Filter to Optimize Noise Figure Measurements

- Step 1.** Press the **Preset** key.
- Step 2.** Set the noise figure correction to Off.
Press the **Input/Output** key and ensure the **Noise Figure Corrections (Off)** menu key is selected.
- Step 3.** Set the Freq Mode to Fixed.
Press the **Frequency** key, the **Freq Mode** menu key, and the **Fixed** menu key.
- Step 4.** Enter the frequency at which you want to measure.
Press the **Frequency** key, the **Fixed Freq** menu key, and enter the numeric value.
- Step 5.** Attach the noise source alone, or the noise source and the DUT, to the Analyzer.
Ensure you have entered the ENR table for the attached noise source.
- Step 6.** Set the View to Meter.
Press the **View/Trace** key and the **Meter** menu key.
- Step 7.** Set the B result to display Y-factor.
Press the **Result B** menu key and the **Y-Factor** menu key.

NOTE

The Y-Factor for centering the preselector at the critical frequency should ideally be greater than 0.2 dB for the procedure to be implemented effectively. This can be made with or without the DUT.

- Step 8.** Set the measurement control to continuous mode.
Press the **Meas Control** key and ensure the **Measure (Cont)** menu key is selected.
- Step 9.** Set the measurement set up averages to on and set averages to 10.
Press the **Meas Setup** key and ensure the **Average (On)** menu key is selected. Use the knob or the numeric keypad to set the averages to 10.
- Step 10.** Press the **Input/Output** key and the **Presel Adjust** menu key.
- Step 11.** Find the point at which the noise figure is at its lowest.
- Step 12.** Make a note of the uncorrected Noise figure value. Note this value as the initial Presel Peak value.
- Step 13.** Adjust the preselector frequency downward until the noise figure increases by greater than 4 dB from the initial Presel Peak value that

you noted. You may need to repeatedly enter numeric values manually.

- Step 14.** Record this Presel Adjust frequency as the Lower Presel Skirt.
- Step 15.** Re-adjust the preselector frequency upward until the noise figure increases by a similar value to that seen in Step 13. You may need to repeatedly enter different frequency values until you locate the correct position.
- Step 16.** Record this Presel Adjust frequency as the Upper Presel Skirt.
- Step 17.** Calculate the mean average of the Lower and the Upper Presel Skirt frequencies, that is, add the Upper Presel Skirt and the Lower presel Skirt results and divide by two. This calculated value is the ideal adjustment for centering the preselector frequency.
- Step 18.** Set the preselector frequency to this calculated frequency.

Noise Figure Uncertainty Calculator

The measurement uncertainty calculator can be used to calculate the RSS (root sum square) measurement uncertainty. Measurement uncertainty is caused by device mismatch and other properties of the noise source, the device under test, and the spectrum analyzer. Once you measure or identify the various device characteristics, they can be entered into the analyzer and it will calculate the RSS uncertainty.

This makes a frequency-independent calculation using one ENR uncertainty value. While it provides a good estimation of the measurement uncertainty, you may want more accuracy. You may want to use more accurate values for ENR, gain and VSWR, or calculate values at a specific frequency of interest or at multiple frequencies. Refer to Application Note 57-2, Agilent part number 5952-3706E, for more information about calculating noise figure uncertainties. This document can be found at: <http://www.agilent.com/find/nfu>

Figure 3-11 Noise Figure Uncertainty Calculator Screen

Agilent 15:22:47 Sep 18, 2003 Noise Figure T

Uncertainty Calculator

...

Noise Source Model Agilent 346B

ENR Uncertainty 0.20 dB Match * 1.15000

	DUT	Instrument
Noise Figure	4.00 dB	8.00 dB
Noise Figure Uncertainty		0.41 dB
Gain	20.00 dB	
Gain Uncertainty		0.83 dB
Input Match *	1.40000	1.60000
Output Match *	1.40000	

Results

RSS Noise Figure Meas Uncert 0.47 dB

* May be entered as Return Loss (-xx.x dB), VSWR or Refl Coefficient

View Calculations

Noise Source For the highest accuracy, and therefore the most meaningful results, you should select 'User Defined' as the Noise Source whenever the actual value of the noise source calibration data is available. This allows you to enter the uncertainty of the Excess Noise Ratio (ENR) and the 50 Ω match (in dB, VSWR, or Reflection Coefficient), which can be from any noise source from any manufacturer. In addition, default values are

provided giving typical parameters for noise sources from Agilent Technologies.

DUT	The device under test will be either an amplifier, upconverter, or downconverter. You will have to enter the measured (or documented) values for its noise figure, input match, output match, and gain into the fields in the calculator. (Gain is only required for an amplifier.)
Instrument	Spectrum analyzer default values are provided. These are reasonable defaults for measurements below 3 GHz using the built-in preamp (Option 1DS). For more accurate calculations, you will need to input the values that are appropriate for your particular measurement and setup.
RSS value	The calculator provides the square root of the sum of the squares (RSS) of the various contributions to uncertainty. This is the recommended way to calculate the total measurement uncertainty since each of the contributing factors are random in nature.
System up/down converters	The calculator is designed to calculate uncertainty for a measurement where the DUT is either an amplifier, a downconverter or an upconverter. It is not designed to calculate the uncertainty when measuring a DUT that is in a measurement setup that includes a system downconverter or system upconverter.

Example Calculation:

- Step 1.** Access the uncertainty calculator by pressing **Mode Setup, Uncertainty Calculator**.
- Step 2.** Suppose that you are testing an amplifier. You must enter the device characteristics into the appropriate DUT fields on the calculator form. Use the arrow keys to tab to the required field. Enter the desired value and terminate your entry by pressing one of the units keys (if provided) or the **Enter** key.
 - gain = 20 dB
 - noise figure = 4 dB
 - input match = 1.4
 - output match = 1.4
- Step 3.** Now read out the calculated RSS uncertainty from the results field at the bottom of the display, as shown in [Figure 3-11 on page 106](#). If you would like more detail about the calculations and factors that contribute to this total uncertainty, use the arrow keys to tab down to the results field and press the **View Calculations** key. You will see a

Advanced Features
Noise Figure Uncertainty Calculator

screen similar to that shown in Figure 3-12.

Figure 3-12 Noise Figure Uncertainty Calculations Screen

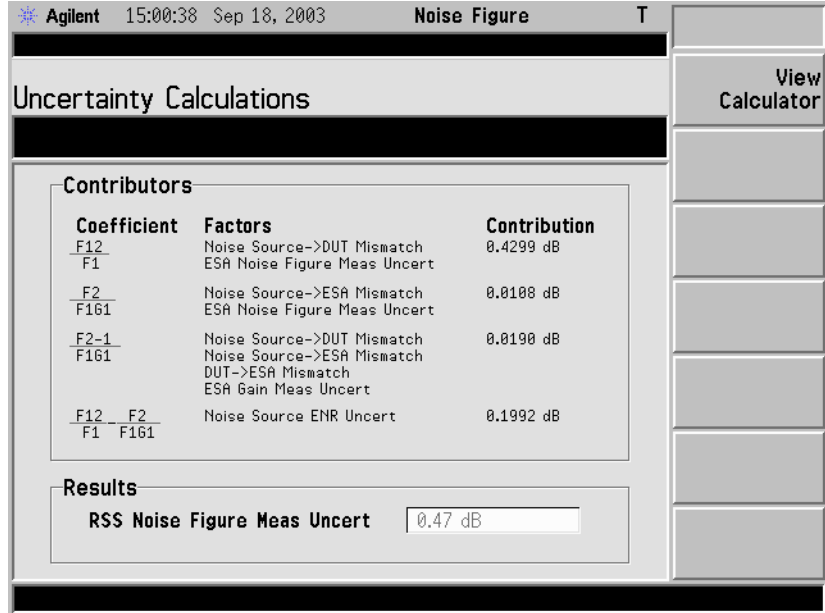

4 Making Frequency Converter Measurements

This chapter describes how to make measurements outside the baseband frequency range of the ESA-E series of analyzers.

What You will Find in this Chapter

This chapter covers:

- Overview of Frequency Converter Measurements
- An overview of the DUT Types
- Comparison of the 8970B, the NFA analyzer and the Option 219 Noise Figure Measurement Application
- Choosing and Setting Up the Local Oscillator
- Connecting the System
- A description of Measuring a Frequency Converting DUT
- Making Frequency Converting DUT Measurements using examples
- A description of Measurements with a System Downconverter
- Measurements with a System Downconverter using examples
- Frequency Restrictions

Overview of Frequency Converter Measurements

Configuring extended frequency measurements involves four steps.

Step 1. Press the **Mode Setup** hard key and the **DUT Setup...** key to select the type of DUT being measured.

For more details on the available DUT types, see “[DUT Types](#)” on [page 113](#).

Step 2. Selecting the type of DUT displays the DUT Setup form. Set the remaining parameters for the measurement.

- **System Downconverter** When measuring an amplifier type DUT, this allows you to specify whether or not the system downconverter is to be used in the measurement.

NOTE

System Downconverter is only applicable when the DUT Type is Amplifier. The system downconverter can not be used with Upconverters and Downconverters.

- **Ext LO Frequency** When measuring an upconverting DUT, or a downconverting DUT, this allows you to specify the fixed LO frequency being fed into the DUT. It also allows you to specify the LO frequency from the system downconverter.
- **Sideband** This allows you to specify whether the measurement is to measure the lower sideband (LSB), the upper sideband (USB), or both upper and lower sideband (double sideband, or DSB).

NOTE

When measuring Upconverter noise, only upper and lower sidebands can be measured at any one time. Double sidebands (DSB) are not applicable.

When measuring Downconverter noise, or an amplifier type DUT with the System Downconverter, you can measure upper sideband (USB), lower sideband (LSB), or double sideband (DSB).

- **Frequency Context** When the DUT is a downconverter or an upconverter, or you are using the system downconverter with an amplifier, you can select whether the frequencies displayed on the analyzer represent the frequencies before or after conversion. Selecting a Frequency Context of **IF Analyzer Input** specifies that the frequencies displayed are after the conversion, that is, the frequencies leaving the DUT or the system downconverter, and entering the analyzer. Selecting a Frequency Context of **RF DUT Input** specifies that the frequencies displayed are the frequencies before the conversion, that is, the frequencies entering the DUT. These are

the same Start and Stop Frequencies that are displayed on the Frequency menu.

- **Diagram** This setting does not affect the measurement directly, but determines whether the diagram displayed on the screen is for calibration or for a measurement. The diagram represents the connections you need to make to perform either a calibration or a measurement using the current settings. The small blue icon of an eye indicates whether the **Frequency Context** is **RF DUT Input** (the icon is beside the DUT input in the diagram) or **IF Analyzer Input** (the eye icon is beside the analyzer input).

Step 3. Configure the measurement (measurement frequency range, number of measurement points and averages and so forth) using the **Frequency/Channel** and **BW/Avg** keys.

For more details on configuring measurements, including calibration, see [Chapter 2](#) , “Making Basic Measurements,” on page 35.

DUT Types

Available modes The Noise Figure measurement personality (Option 219) allows you to measure the following types of DUT. You set the DUT Type by pressing the **Mode Setup** key on the front panel and the **DUT Setup...** key:

- **Amplifier:** The DUT is an amplifier-type device with no frequency conversion. This is the basic measurement mode where the measurement frequency is within the analyzer's frequency range.

NOTE The **Amplifier** DUT is for any DUT that does not perform frequency conversion and includes amplifiers, filters, attenuators and so forth.

If you wish to measure the noise figure of an amplifier at a frequency outside the range of the analyzer, set DUT to Amplifier, and set **System Downconverter** to **On**. The LO must be fixed

- **Downconv:** The DUT is a frequency downconverter (that is, frequency downconversion occurs in the DUT itself). The LO must be fixed.
- **Upconv:** The DUT is a frequency upconverter (that is, frequency upconversion occurs in the DUT itself). The LO must be fixed.

Noise figure measurements involving frequency converters are necessary when:

- The frequency conversion is part of the DUT. For example, the DUT is a mixer or a receiver.
- The frequency conversion is part of the measurement test set-up. The DUT is to be measured at a higher frequency than the analyzer's frequency range covers, hence an external mixer and local oscillator are added to the measurement test set-up to convert this frequency to a frequency within the analyzer's range.

The Noise Figure measurement personality (Option 219) can make a single frequency conversion, either in the DUT, or as an added **System Downconverter**, which configures the analyzer as a frequency range extender.

NOTE The Noise Figure measurement personality (Option 219) can not control an external LO source remotely. You can only specify a fixed frequency for that LO, so any sweeping must be done by the internal LO under the control of the analyzer.

Basic Measurement — No Frequency Conversion

The basic measurement setup is shown in [Figure 4-1](#), allowing you to compare more complex setups with it.

Figure 4-1 ESA Basic Noise Figure Measurement - No Frequency Conversion

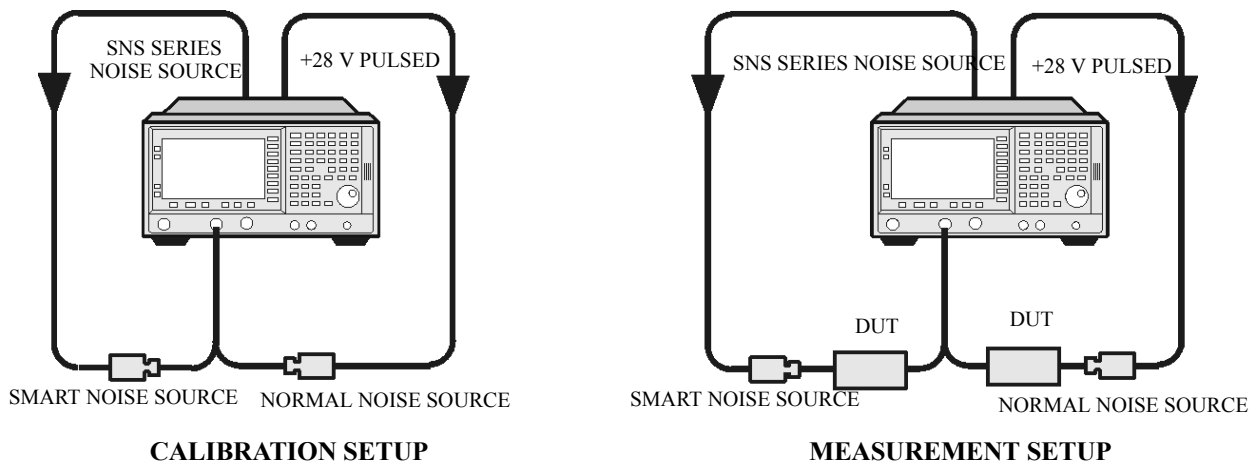

When you are performing an uncorrected measurement, the result is the measured Noise Figure of all of the components after the noise source. When the calibration setup is connected and the calibration performed, the Noise Figure measurement personality (Option 219) measures its own noise figure and that of the connection set up. If you then make a corrected measurement, the contribution of the calibration setup is subtracted from the uncorrected result, giving a corrected measurement of the DUT only.

Press the **Mode Setup** key, followed by the **DUT Setup...** key to access the DUT Setup form. Set the **DUT** and the **System Downconverter** as shown in the following table.

DUT	Amplifier
System Downconverter	Off

Frequency Downconverting DUT

In this mode, the DUT contains a frequency downconverting device, for example, a mixer or receiver.

Making this measurement, the external Local Oscillator (LO) remains locked at one frequency and the Noise Figure measurement personality (Option 219) does the sweeping. It is not possible to control a variable frequency on the external LO.

Variable IF Fixed LO (equivalent to Mode 1.4 on an 8970B Noise Figure Meter)

This is an overview of the key presses needed to set up this type of measurement, see [“Frequency Restrictions” on page 156](#), and [“Making Frequency Converting DUT Measurements” on page 141](#) for an example of this measurement. This shows how to make an LSB measurement. However, you need to change the settings and apply the appropriate filtering. For greater detail on this see [“Measuring a Frequency Converting DUT” on page 129](#).

Press the **Mode Setup** key, followed by the **DUT Setup...** key to access the DUT Setup form. Set the values on the DUT Setup form as shown in the following table.

DUT	DownConv
System Downconverter	Disabled
Ext LO Frequency	Enter a value
Sideband	LSB, USB or DSB . See the important notes on page 116 .
Frequency Context	IF Analyzer Input or RF DUT Input . This determines whether you specify the measurement frequencies at the DUT input (RF DUT Input) or at the analyzer’s input (IF Analyzer Input). See Frequency Context (below) for a more detailed description.
Diagram	Calibration or Measurement . This does not affect the measurement or calibration, but indicates how the noise source, the DUT and the analyzer should be set up. The blue eyeball icon acts as a visual reminder of the Frequency Context setting you have selected. See Frequency Context (below) for a more detailed description. See also the important note on page 116 .

Frequency Context

You can select whether to specify the frequencies at the DUT input (**RF DUT Input**) or at the analyzer’s input (**IF Analyzer Input**). The setting you select is indicated visually on the setup diagram by the blue ‘eye’ icon.

- **IF Analyzer Input:** You specify the frequencies at the analyzer's input, that is, at the DUT output after downconversion has taken place.

You specify the Start frequency and Stop Frequency using the Frequency menu, which is accessed by pressing the **FREQUENCY/Channel** key. The frequencies you specify are the frequencies at which the analyzer will make its measurements. These are the same frequencies that are shown on the results graph, in the results table, and on the results meter.

The DUT Setup form (**Mode Setup, DUT Setup...**) has a blue 'eye' icon just above the IF Start and the IF Stop frequencies, which indicates that you have specified the frequencies at the analyzer input.

The RF Start and RF Stop frequencies are also displayed on the setup diagram. These are calculated from the specified IF Start and IF Stop frequencies, and the external LO frequency.

- **RF DUT Input:** You specify the frequencies at the DUT input, that is, before downconversion has taken place.

You specify the Start frequency and Stop Frequency using the Frequency menu, which is accessed by pressing the **FREQUENCY Channel** key. The frequencies you specify are the frequencies at the input to the DUT. These frequencies are then converted by the downconverter before being measured by the analyzer, and consequently do not represent the frequencies actually being measured by the analyzer.

The frequencies displayed on the results graph, in the results table, and on the results meter are the DUT input frequencies that you have specified. These displayed result frequencies do not represent the actual frequencies being measured by the analyzer.

The DUT Setup form (**Mode Setup, DUT Setup...**) has a blue 'eye' icon just above the RF Start and the RF Stop frequencies, which indicates that you have specified the frequencies at the DUT input.

The IF Start and IF Stop frequencies are also displayed on the setup diagram. These are calculated from the specified RF Start and RF Stop frequencies, and the external LO frequency.

NOTE

When making a Double Side Band (**DSB**) measurement with **RF DUT Input** Frequency Context, the frequencies you specify as the RF Start and RF Stop frequencies refer to the Lower Side Band only. There is no ambiguity when making Upper Side Band (**USB**) or Lower Sideband measurements (**LSB**), or when specifying frequencies at the analyzer input, that is, with Frequency Context of **IF Analyzer Input**.

NOTE

When making Double Sideband (**DSB**) measurements, it is important that the IF frequency is much smaller than the LO frequency. This is because the ENR values in the ENR table can only be applied to one

frequency, which is the LO frequency. The ENR values can not be applied simultaneously to both the upper sideband and to the lower sideband. The ENR values are therefore applied to the midpoint between the upper sideband and the lower sideband, and this equates to the LO frequency.

Consequently, the higher the IF frequency is in comparison to the LO frequency, the further apart the upper and lower sidebands will be. The further these upper and lower sidebands are from the LO frequency, the less accurate will the ENR value be.

Another potential source of error is the frequency response of the DUT. If the frequency response varies over the measurement range, from lower to upper frequency, the noise figure results will only represent an average value.

It is recommended for greatest accuracy that the IF frequency be no greater than 1% of the LO frequency when making double sideband measurements. When making a swept measurement, no frequency in the swept frequency band should exceed 1% of the LO frequency.

NOTE

Filtering is needed to remove the unwanted sideband when making single-sideband measurements. Filtering is also needed to filter out any LO leakage in the IF path. Ideally any filters should be included in the calibration path. However, if they are not in the path, you can enter loss compensation to account for any additional error.

The ESA-E series of spectrum analyzers have a 3.0 GHz low pass filter which needs to be taken into account when planning the filter requirements during measurement and calibration.

Frequency Upconverting DUT

In this mode, the DUT contains a frequency upconverting device, for example, a mixer used in the transmit path of a radio.

Making this measurement, the external Local Oscillator (LO) remains locked at one frequency and the Noise Figure measurement personality (Option 219) does the sweeping. It is not possible to control a variable frequency on the external LO.

NOTE

Filtering is needed to remove the unwanted sideband when making single-sideband measurements. Filtering is also needed to filter out any LO leakage in the IF path. Ideally any filters should be included in the calibration path. However, if they are not in the path, you can enter loss compensation to account for any additional error.

The ESA-E series of spectrum analyzers have a 3.0 GHz Low Pass Filter which needs to be taken into account when planning the filter requirements during measurement and calibration.

Variable IF Fixed LO (equivalent to Mode 1.4 with SUM Sideband on an 8970B Noise Figure Meter)

This is an overview of the key presses needed to set up this type of measurement. For further details on frequency restrictions, see [“Frequency Restrictions” on page 156](#).

For an example of this measurement, see [“Making Frequency Converting DUT Measurements” on page 141](#). This shows you how to make an LSB measurement. However, you need to change the settings and apply the appropriate filtering. For further details on this, see [“Measuring a Frequency Converting DUT” on page 129](#).

Press the **Mode Setup** key, followed by the **DUT Setup...** key to access the DUT Setup form. Set the values on the DUT Setup form as shown in the following table.

DUT	UpConv
System Downconverter	Disabled
Ext LO Frequency	Enter a value
Sideband	LSB or USB
Frequency Context	IF Analyzer Input or RF DUT Input . This determines whether you specify the measurement frequencies at the DUT input (RF DUT Input) or at the analyzer's input (IF Analyzer Input). See Frequency Context (below) for a more detailed description.
Diagram	Calibration or Measurement . This does not affect the measurement or calibration, but indicates how the noise source, the DUT and the analyzer should be set up. The blue eyeball icon acts as a visual reminder of the Frequency Context setting you have selected. See Frequency Context (below) for a more detailed description.

Frequency Context

You can select whether to specify the frequencies at the DUT input (**RF DUT Input**) or at the analyzer's input (**IF Analyzer Input**). The setting you select is indicated visually on the setup diagram by the blue 'eye' icon.

- **IF Analyzer Input:** You specify the frequencies at the analyzer's input, that is, at the DUT output after upconversion has taken place.

You specify the Start frequency and Stop Frequency using the Frequency menu, which is accessed by pressing the **FREQUENCY Channel** key. The frequencies you specify are the frequencies at which the analyzer will make its measurements. These are the same frequencies that are shown on the results graph, in the results table, and on the results meter.

The DUT Setup form (**Mode Setup, DUT Setup...**) has a blue 'eye' icon just above the IF Start and the IF Stop frequencies, which indicates that you have specified the frequencies at the analyzer input.

The RF Start and RF Stop frequencies are also displayed on the setup diagram. These are calculated from the specified IF Start and IF Stop frequencies, and the external LO frequency.

- **RF DUT Input:** You specify the frequencies at the DUT input, that is, before upconversion has taken place.

You specify the Start frequency and Stop Frequency using the Frequency menu, which is accessed by pressing the **FREQUENCY Channel** key. The frequencies you specify are the frequencies at the input to the DUT. These frequencies are then converted by the upconverter before being measured by the analyzer, and

DUT Types

consequently do not represent the frequencies actually being measured by the analyzer.

The frequencies displayed on the results graph, in the results table, and on the results meter are the DUT input frequencies that you have specified. These displayed result frequencies do not represent the actual frequencies being measured by the analyzer.

The DUT Setup form (**Mode Setup, DUT Setup...**) has a blue 'eye' icon just above the RF Start and the RF Stop frequencies, which indicates that you have specified the frequencies at the DUT input.

The IF Start and IF Stop frequencies are also displayed on the setup diagram. These are calculated from the specified RF Start and RF Stop frequencies, and the external LO frequency.

System Downconverter

The DUT is a non-frequency converting device, for example an amplifier or filter, and its frequency is higher than the analyzer's measurement range. Frequency downconversion is required within the measurement system, using a mixer external to the DUT, to convert the signal of interest to the frequency range of the analyzer.

Making this measurement, the external Local Oscillator (LO) remains locked at one frequency and the Noise Figure measurement personality (Option 219) does the sweeping. It is not possible to control a variable frequency on the external LO.

NOTE

Filtering is needed to remove the unwanted sideband when making single-sideband measurements. Filtering is also needed to filter out any LO leakage in the IF path. Ideally any filters should be included in the calibration path. However, if they are not in the path, you can enter loss compensation to account for any additional error.

The ESA-E series of spectrum analyzers have a 3.0 GHz Low Pass Filter which needs to be taken into account when planning the filter requirements during measurement and calibration of any measurement made at or below 3 GHz.

Fixed LO Variable IF (equivalent to Mode 1.2 on an 8970B Noise Figure Meter)

These are an overview of the key presses needed to set up this type of measurement. See [“Frequency Restrictions” on page 156](#) for the restrictions applicable to this measurement. See [“Measurements with a System Downconverter” on page 149](#) for an example of this type of measurement. You will need to change the settings and apply the appropriate filtering. For greater detail on this, see [“Measurements with a System Downconverter” on page 149](#).

Press the **Mode Setup** key, followed by the **DUT Setup...** key to access the DUT Setup form. Set the values on the DUT Setup form as shown in the following table.

DUT	Amplifier
System Downconverter	On
Ext LO Frequency	Enter a value
Sideband	LSB, USB or DSB
Frequency Context	IF Analyzer Input or RF DUT Input. This determines whether you specify the measurement frequencies at the DUT input (RF DUT Input) or at the analyzer's input (IF Analyzer Input). See Frequency Context (below) for a more detailed description.
Diagram	Calibration or Measurement. This does not affect the measurement or calibration, but indicates how the noise source, the DUT and the analyzer should be set up. The blue eyeball icon acts as a visual reminder of the Frequency Context setting you have selected. See Frequency Context (below) for a more detailed description.

Frequency Context

You can select whether to specify the frequencies at the DUT input (**RF DUT Input**) or at the analyzer's input (**IF Analyzer Input**). The setting you select is indicated visually on the setup diagram by the blue 'eye' icon.

- **IF Analyzer Input:** You specify the frequencies at the analyzer's input, that is, at the DUT output after upconversion has taken place.

You specify the Start frequency and Stop Frequency using the Frequency menu, which is accessed by pressing the **FREQUENCY Channel** key. The frequencies you specify are the frequencies at which the analyzer will make its measurements. These are the same frequencies that are shown on the results graph, in the results table, and on the results meter.

The DUT Setup form (**Mode Setup, DUT Setup...**) has a blue 'eye' icon just above the IF Start and the IF Stop frequencies, which indicates that you have specified the frequencies at the analyzer input.

The RF Start and RF Stop frequencies are also displayed on the setup diagram. These are calculated from the specified IF Start and IF Stop frequencies, and the external LO frequency.

- **RF DUT Input:** You specify the frequencies at the DUT input, that is, before upconversion has taken place.

You specify the Start frequency and Stop Frequency using the Frequency menu, which is accessed by pressing the **FREQUENCY Channel** key. The frequencies specified are the frequencies at the input to the DUT. These frequencies are then converted by the upconverter before being measured by the analyzer, and

consequently do not represent the frequencies actually being measured by the analyzer.

The frequencies displayed on the results graph, in the results table, and on the results meter are the DUT input frequencies that you have specified. They are also used to determine the ENR values used in the calculations. These displayed result frequencies do not represent the actual frequencies being measured by the analyzer.

The DUT Setup form (**Mode Setup, DUT Setup...**) has a blue 'eye' icon just above the RF Start and the RF Stop frequencies, which indicates that the frequencies have been specified at the DUT input.

The IF Start and IF Stop frequencies are also displayed on the setup diagram. These are calculated from the specified RF Start and RF Stop frequencies, and the external LO frequency.

NOTE When making a Double Side Band (**DSB**) measurement with **RF DUT Input** Frequency Context, the frequencies you specify as the RF Start and RF Stop frequencies refer to the Lower Side Band only. There is no ambiguity when making Upper Side Band (**USB**) or Lower Sideband measurements (**LSB**), or when specifying frequencies at the analyzer input, that is, with Frequency Context of **IF Analyzer Input**.

NOTE When making Double Sideband (**DSB**) measurements, it is important that the IF frequency is much smaller than the LO frequency. This is because the ENR values in the ENR table can only be applied to one frequency or, in the case of a swept measurement, to one set of frequencies. The ENR values can not be applied simultaneously to both the upper sideband and to the lower sideband. The ENR values are therefore applied to the midpoint between the upper sideband and the lower sideband, and this equates to the LO frequency.

Consequently, the higher the IF frequency is in comparison to the LO frequency, the further apart the upper and lower sidebands will be. The further these upper and lower sidebands are from the LO frequency, the less accurate will the ENR value be.

Another potential source of error is the frequency response of the DUT. If the frequency response varies over the measurement range, from lower to upper frequency, the noise figure results will only represent an average value.

It is recommended for greatest accuracy that the IF frequency be no greater than 1% of the LO frequency when making double sideband measurements. When making a swept measurement, no frequency in the swept frequency band should exceed 1% of the LO frequency.

Comparison of the 8970B, the NFA analyzer and the Option 219 Noise Figure Measurement Application

Table 4-1 shows the relationship between the 8970B Noise Figure Analyzer, the NFA Series, and the ESA Series Option 219 Noise Figure Measurement application.

Table 4-1 8970B / NFA / Option 219 Measurement Cross Reference

8970B	NFA Series	ESA Option 219
Mode 1.1: Swept LO	System Downconverter Fixed IF Variable LO	Not supported
Mode 1.2: Fixed LO	System Downconverter Variable IF Fixed LO	System downconverter Fixed LO
Mode 1.3: Swept LO	Downconverting Fixed IF Variable LO	Not supported
Mode 1.4: Fixed LO	Downconverting Variable IF Fixed LO	DUT = Downconv Fixed LO
Mode 1.3 with SUM Sideband: Swept LO	Upconverting Fixed IF Variable LO, USB	Not supported
Mode 1.4 with SUM Sideband: Fixed LO	Upconverting Variable IF Fixed LO, USB	DUT = Upconv Fixed LO Sideband = USB

Choosing and Setting Up the Local Oscillator

Selecting a Local Oscillator for Extended Frequency measurements with Option 219

Because of reciprocal mixing, noise components in the LO are converted into the IF band applied to the analyzer. This converted LO noise causes the measured noise figure to be higher than the noise figure of the mixer.

If the mixer is to be used with a particular LO in its final application, its noise figure should be measured with the same LO. The measurement then gives the noise figure for the combination of extended frequency device and LO in the final system.

For testing of extended frequency measurements, the LO must have a low noise floor over frequencies equal to the $LO \pm IF$. It is also important that the LO has low broad-band noise because any noise at the IF frequency will pass through to the IF and distort the results.

Effect of high LO spurious signals and noise on mixer measurements with low L-to-I rejection.

The spurious level of the LO also has to be low. At frequencies where there is a high spurious signal, the noise figure measured will have a peak at that IF. For example, ideally the LO's noise, including spurious, needs to be below -90 dBm. If a mixer has higher isolation, then the noise of the LO can be higher since the mixer will be better able to reject the LO's noise.

This is especially necessary if the mixer has a poor balance, or L-to-I isolation. With low isolation, the mixer is more likely to pass the LO noise through and thus increase the measured noise figure.

NOTE

L-to-I rejection is the mixer's ability to reject the fundamental, harmonics and spurious signals of the LO, and not allow them to pass through to the IF output.

Selecting a Local Oscillator for Option 219

Here are several criteria that must be met when choosing the LO:

1. It should have a frequency appropriate to the DUT's frequency range, IF range, and sideband chosen.
2. It should have sufficient power to drive mixers (typically, +7 dBm)
3. It should have excellent frequency accuracy and repeatability (typically, the same as the analyzer you are using.)

The last point, frequency accuracy, deserves further comment. There are three frequency-dependent components in a noise figure measurement that must all be aligned to make an accurate measurement at the IF. The need for frequency accuracy is the main reason for recommending a synthesized source for the LO, such as the Agilent 83712B Synthesized CW Generator.

Other LOs may be used, but should be tested to determine that their noise is sufficiently low, as LO noise can cause an increase in noise figure for the mixer/LO combination, and calibration of the system may not be possible. A broad-band, high gain amplifier at the LO output usually generates unacceptable noise. This is almost always the case when a heterodyne-type sweep oscillator or signal generator is used.

NOTE

When making double sideband (**DSB**) measurements, it is important that the IF frequency is much smaller than the LO frequency. This is because the ENR values in the ENR table can only be applied to one frequency or, in the case of a swept measurement, to one set of frequencies. The ENR values can not be applied simultaneously to both the upper sideband and to the lower sideband. The ENR values are therefore applied to the midpoint between the upper sideband and the lower sideband, and this equates to the LO frequency.

Consequently, the higher the IF frequency is in comparison to the LO frequency, the further apart the upper and lower sidebands will be. The further these upper and lower sidebands are from the LO frequency, the less accurate will the ENR value be.

Another potential source of error is the frequency response of the DUT. If the frequency response varies over the measurement range, from lower to upper frequency, the noise figure results will only represent an average value.

It is recommended for greatest accuracy that the IF frequency be no greater than 1% of the LO frequency when making double sideband measurements. When making a swept measurement, no frequency in the swept frequency band should exceed 1% of the LO frequency.

Connecting the System

Figure 4-3 shows the connection diagram options you use to calibrate the ESA analyzer with Option 219, and after calibration, to measure a DUT, whether it is a downconverter, an upconverter, amplifier, or a filter. It does not show where to place a filter to remove any unwanted sideband or input noise.

Setting Up the Noise Figure Analyzer

You can connect the 10 MHz timebase references, thus locking the analyzer and the LO to the same frequency reference.

To connect the 10 MHz reference output from the ESA-E Series analyzer to the LO, connect the **10 MHz REF OUT** to the **10 MHz REF IN** of the LO.

NOTE

To connect the 10 MHz reference output from the LO to an ESA-E Series analyzer, connect the **10 MHz REF OUT** of the LO to the **10 MHz REF IN** of the analyzer.

To connect the analyzer and make your measurements:

- Step 1.** Turn the analyzer on and press the **Preset** key to return the analyzer to a known state. Go into the Noise Figure mode if the preset is not set to **Mode**.
- Step 2.** Enter the ENR values in to the analyzer. See [“Entering Excess Noise Ratio \(ENR\) Data” on page 37](#) for the procedures to do this.
- Step 3.** Follow the procedure to calibrate the system, and measure the DUT.

Figure 4-2 Setting Up a Frequency Converting DUT Measurement

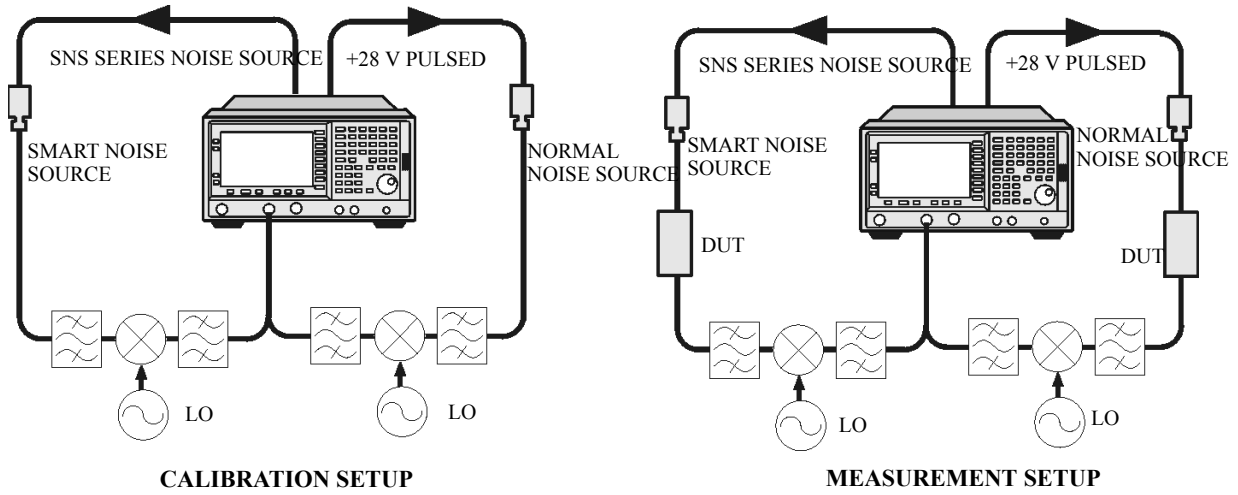

Measuring a Frequency Converting DUT

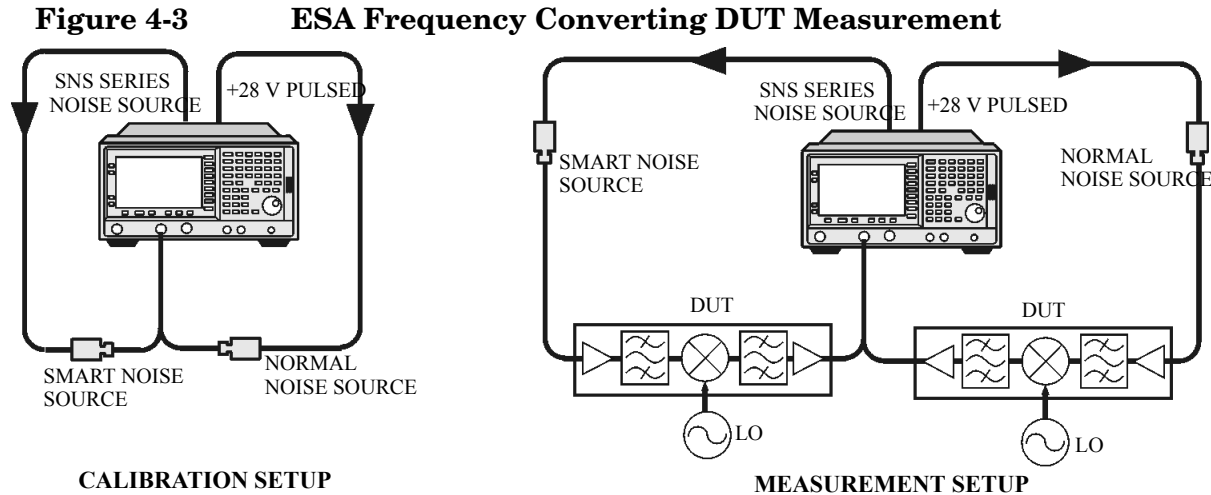

In this measurement, the DUT performs frequency conversion in the measurement setup. However, there is no frequency conversion in the calibration setup, as is shown in [Figure 4-3](#). The purpose of the calibration setup is to allow the analyzer to measure its own noise figure and sensitivity with the noise source. This must be performed across the frequency range to which the analyzer will tune when performing the measurement.

For both calibration and for measurement, a normal noise source must be connected to the **+28 V PULSED** on an ESA-E Series analyzer. An Agilent Technologies Smart Noise Source (SNS) must be connected to **SNS SERIES NOISE SOURCE** on the rear panel of an ESA-E Series analyzer.

The LO frequency reference may be connected to the **10 MHz REF OUT** on an ESA-E Series analyzer. This locks the LO and the analyzer together for greater measurement accuracy.

For these measurements you must access the **DUT Setup...** screen (**Mode Setup, DUT Setup...**), and set the following parameters:

DUT	Upconv or Downconv
System Downconverter	Not accessible
Ext LO Frequency	Enter a value for the LO's frequency
Sideband	LSB, USB or DSB (Downconverters only)

Frequency Context	IF Analyzer Input or RF DUT Input . This determines whether you specify the measurement frequencies at the DUT input (RF DUT Input) or at the analyzer's input (IF Analyzer Input). See Frequency Context (below) for a more detailed description.
Diagram	Calibration or Measurement . This does not affect the measurement or calibration, but indicates how the noise source, the DUT and the analyzer should be set up. The blue 'eye' icon acts as a visual reminder of the Frequency Context setting you have selected. See Frequency Context (below) for a more detailed description.

Frequency Context

You can select whether to specify the frequencies at the DUT input (**RF DUT Input**) or at the analyzer's input (**IF Analyzer Input**). The setting you select is indicated visually on the setup diagram by the blue 'eye' icon.

- **IF Analyzer Input:** You specify the frequencies at the analyzer's input, that is, at the DUT output after upconversion has taken place.

You specify the Start frequency and Stop Frequency using the Frequency menu, which is accessed by pressing the **FREQUENCY Channel** key. The frequencies you specify are the frequencies at which the analyzer will make its measurements. These are the same frequencies that are shown on the results graph, in the results table, and on the results meter. When the measurement is made, the analyzer calculates the input frequency to the DUT, and using the appropriate values from the noise source ENR table, interpolates as necessary and measures the DUT.

The DUT Setup form (**Mode Setup, DUT Setup...**) has a blue 'eye' icon just above the IF Start and the IF Stop frequencies, which indicates that you have specified the frequencies at the analyzer input.

The RF Start and RF Stop frequencies are also displayed on the setup diagram. These are calculated from the specified IF Start and IF Stop frequencies, and the external LO frequency.

- **RF DUT Input:** You specify the frequencies at the DUT input, that is, before upconversion has taken place.

You specify the Start frequency and Stop Frequency using the Frequency menu, which is accessed by pressing the **FREQUENCY Channel** key. The frequencies you specify are the frequencies at the input to the DUT. These frequencies are then converted by the upconverter before being measured by the analyzer, and consequently do not represent the frequencies actually being measured by the analyzer. When the measurement is made, the analyzer calculates the input frequency to the analyzer, and using the appropriate values from the noise source ENR table, interpolates as necessary and measures the DUT.

The frequencies displayed on the results graph, in the results table, and on the results meter are the DUT input frequencies that you have specified. These displayed result frequencies do not represent the actual frequencies being measured by the analyzer.

The DUT Setup form (**Mode Setup, DUT Setup...**) has a blue 'eye' icon just above the RF Start and the RF Stop frequencies, which indicates that you have specified the frequencies at the DUT input.

The IF Start and IF Stop frequencies are also displayed on the setup diagram. These are calculated from the specified RF Start and RF Stop frequencies, and the external LO frequency.

NOTE When making a Double Side Band (**DSB**) measurement with **RF DUT Input** Frequency Context, the frequencies you specify as the RF Start and RF Stop frequencies refer to the Lower Side Band only.

NOTE The Upconverter and Downconverter modes include any DUT that performs frequency conversion, whether a simple single mixer or a complex receiver structure.

Sidebands and Images

For any measurement involving frequency conversion, you need to consider the exact frequency ranges involved, and make decisions about the filtering requirements for the specific measurement. For example, there may be several different methods of measuring a mixer, and the method chosen may be set by the choice of available filters.

Figure 4-4

Sidebands and Images with Downconversion

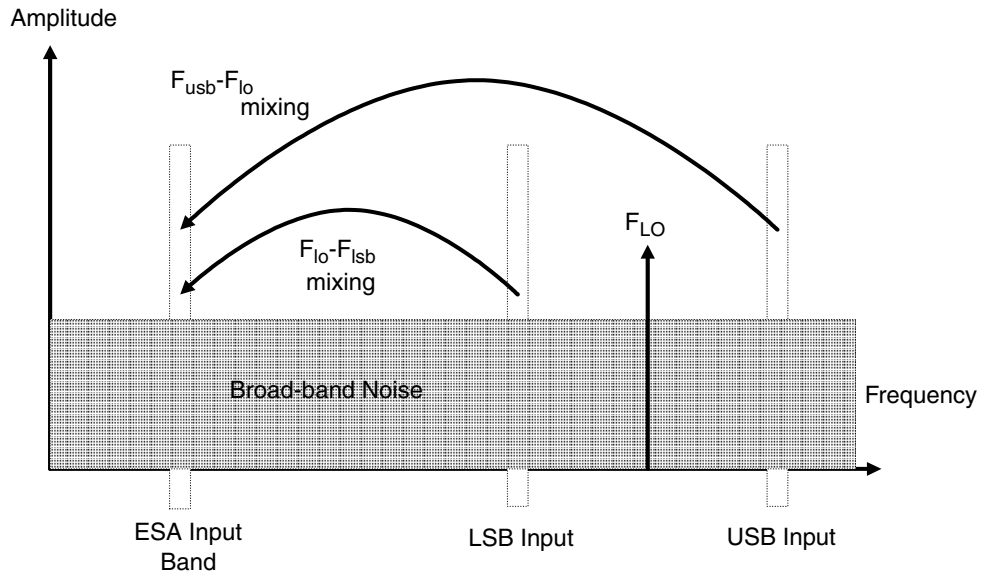

Simple, ideal, mixers output signals on both the sum and difference of their RF and LO frequencies. Hence, for a fixed output frequency and a fixed LO frequency, there are two different input frequencies that are converted to the output frequency. This is shown in [Figure 4-4](#).

The noise sources used in noise figure measurements are broad-band. When using a downconverter, there is a probability that noise will be presented to a simple mixer in both the upper and lower input frequency bands that are converted into the same IF output band to which the analyzer is tuned. The analyzer receives mixer-created noise from the two frequency bands which are superimposed. The noise is random, and hence the two power levels combine by simple addition. Similarly, the analyzer receives noise-source-created noise from the two frequency bands combined as added power. Any measurement where two mixing products are combined like this is usually termed double-sideband (DSB).

It is conventional to call the higher frequency band of an image pair the Upper-Sideband (USB), and the lower frequency band of an image pair the Lower-Sideband (LSB).

Non-ideal mixers exhibit some unwanted behaviors:

1. Some of the input signal leaks directly to the output.

2. Some of the LO signal, and its harmonics, leak directly to the output.
3. Mixing products are created between the input signal and the harmonics of the LO.

There are other unwanted products involving input signal harmonics, but these tend to be less troublesome than those above, provided the mixer is operated at a level within its linear range.

Signal Leakage

Direct signal leakage of input signal through to a mixer's output can occur, because the noise sources cover a broad frequency range. Signal leakage is not normally a problem unless the noise source has a large variation in ENR, or the mixer's RF-to-IF leakage is high.

LO Leakage

The LO power is normally greater than the largest input signal that a mixer is intended to operate with. The LO power leaking from the mixer's output is at a high level compared to the signal levels involved in the noise figure measurement. Hence, LO leakage needs to be considered when measuring noise figure of a frequency converting DUT.

If the LO frequency is low enough to be passed by the input filter of the analyzer's RF section (a 3.0 GHz Low Pass Filter), the LO leakage can prevent successful measurement of the DUT noise figure.

Desensitization by LO leakage can be avoided by adding a filter between the DUT and the analyzer to remove the LO frequency component.

Low pass filters with cutoffs at low frequencies, may exhibit spurious resonances and leakage at low microwave frequencies. It may be necessary to use a pair of lowpass filters, one microwave, one RF, in order to assure a stopband attenuation over a wide frequency range.

LO Harmonics

Many mixers are operated by sinusoidal LO signals. LO harmonics can be formed in the mixer at significantly high levels. It is common for the specified LO input level for a diode mixer to be chosen to operate the diodes between saturation and off conditions, hence making the mixer act as a switch. LO harmonic derived products from industry standard double-balanced mixers may be similar in level to what they would have been with a square-wave LO signal. Instead of just being sensitive at one pair of frequencies $[F_{LO} \pm F_{IF}]$, the mixer input is sensitive at a series of pairs:

Equation 4-1

$$[F_{LO} \pm F_{IF}] + [2F_{LO} \pm F_{IF}] + [3F_{LO} \pm F_{IF}] + [4F_{LO} \pm F_{IF}] + [5F_{LO} \pm F_{IF}] + \dots$$

Filtering is needed to eliminate the noise input to the DUT at these higher order frequencies. However, their frequencies may be great enough that the mixer attenuates them, making them insignificant.

Single Sideband Measurements

Most mixer applications involve single sideband (SSB) mixing - either LSB or USB, hence it is ideal to make noise figure measurements on a mixer in the circumstances in which it is used. Making an SSB measurement requires suitable filters to remove the unwanted image, any LO leakage, and other unwanted mixer products. This may require filters that are not readily available, or that are expensive, and a DSB measurement may be chosen as a compromise when measuring a downconverter or using the System Downconverter. There is no general guidance on what filtering is needed. Each case needs individual consideration.

Items to be considered are:

1. Decide the frequency ranges that must be covered; Input, LO, and Output.
2. Calculate the frequency range that the unwanted image will cover.
3. Calculate the frequency range that the LO harmonic modes will cover.
4. Choose a filter to go between the noise source and the DUT, that will pass the wanted input band and stop the unwanted input bands.
5. Consider the LO frequency range (and harmonics), and whether or not a filter is needed to protect the analyzer input from being desensitized by LO leakage in the 0 - 3.5 GHz range.
6. Choose a filter, if necessary, to go between the DUT and the analyzer.

If any of these ranges conflict, making the filter requirements impossible, the measurement could be split into a group of smaller ranges, with different filters for each.

If the DUT is a complicated mixer, it may already contain filters to operate the mixer in single sideband mode over the frequency range of interest. A mixer in its final application exhibits the same problems that make noise figure measurement difficult, hence the application will need similar filtering to that needed during noise figure measurement.

Figure 4-5 Single Sideband Mixer Measurements

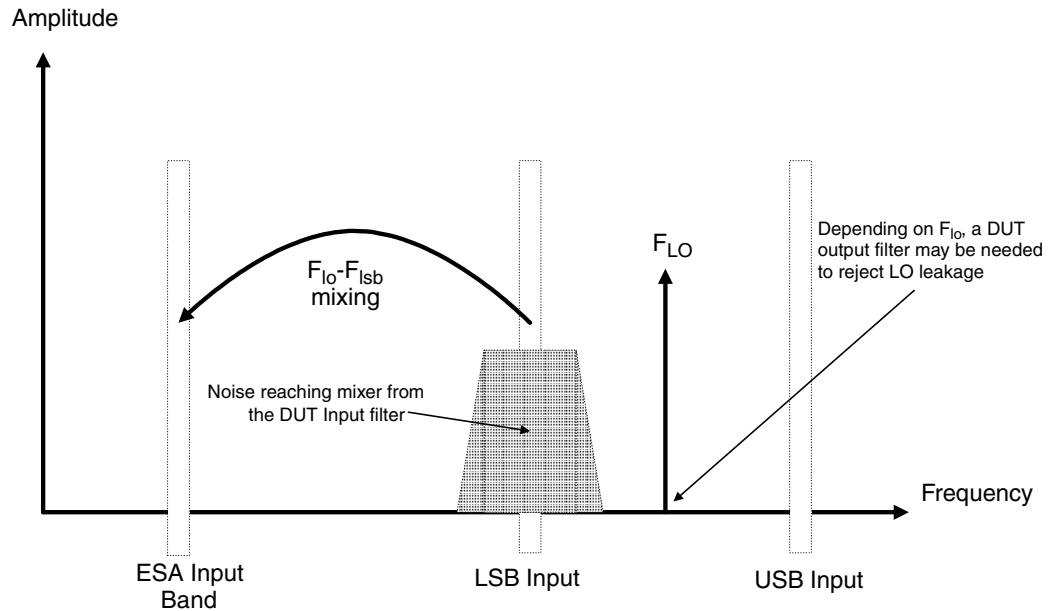

Figure 4-5 shows an SSB mixer measurement (Downconverter, LSB) where a filter makes it single sideband. If the IF frequency is lowered, the analyzer is tuned to a lower frequency, and the USB and LSB bands will move closer to the LO frequency. This makes filtering more difficult. If the IF is lowered further, a point is reached where filtering is not possible and SSB measurements cannot be made. The width of the filter limits where the LO or IF frequencies sweep to make a measurement.

The analyzer performs frequency calculations and controls the frequency for a variety of mixer modes. However, you have to determine the filter requirements, and provide those filters in the measurement setup.

'Downconverter' means that the output frequency, (IF) is lower than the input, (RF).

'Upconverter' means that the output frequency, (IF) is higher than the input (RF).

The analyzer can handle SSB mixer measurements in modes defined by the following combinational choices:

- **DUT: Upconverter, Downconverter, or Amplifier with System Downconverter On.**
- **Sideband: LSB or USB.**

Double Sideband Measurements

Double Sideband (DSB) measurements can only be made when the DUT is a downconverter, or when the DUT is an amplifier and the system downconverter is On. DSB techniques can be useful when making noise figure measurements under the following conditions:

- When adequate filters for image-free SSB measurements are not available
- When frequency ranges have to be covered that make SSB filters impractical or impossible

DSB measurements do not eliminate the need for filtering. However, they can greatly simplify the filtering needed. This benefit is achieved at the loss of frequency resolution.

Figure 4-6 Double Sideband Measurements

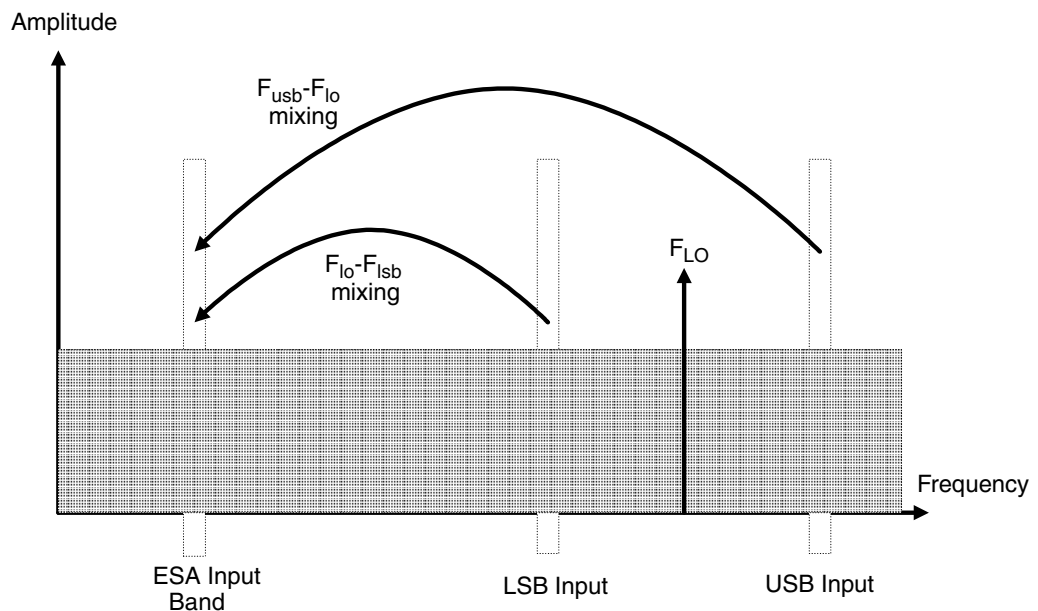

Figure 4-6 shows a double sideband, downconversion, mixing. Noise from two separated RF bands are mixed into the IF band, where the power addition takes place.

DSB measurements are made with the noise from a pair of separate bands, symmetrically arranged about the LO frequency. The IF frequency value should be low, ideally no larger than 1% of the LO frequency. As the two sidebands, the USB and the LSB, are generated at frequencies equal to $LO \pm IF$, this technique maintains the two bands close together. This is necessary because the assumption is made that the variations in noise source ENR, gain and noise figure are constant between the two bands. ENR values are applied to the mid-point between the upper and lower sidebands, and this equates to the frequency of the LO.

Figure 4-6 shows that noise from two bands are combined during the measurement, while during calibration, when the DUT was not connected, only one band (at the IF frequency) was used.

If the assumptions about the parameters being flat over frequency between the two sidebands are valid, your results will show a doubling in power (3 dB increase) in noise level during the measurement of any downconverting DUTs. There is also a doubling of measured power when using the system downconverter, but compensation is not required because the calibration power is also doubled.

This 3 dB increase in measured power with downconverting DUTs can be corrected using the Loss Compensation Setup screen (**Input/Output, Loss Comp**). Set **Loss Compensation Before DUT** to **Fixed**, enter a **Fixed Value** of -3 dB, and set **Temperature** to the noise source's cold temperature. The DSB power addition occurs for both the *Hot* and *Cold* noise from the noise source, and the noise created in the input of the DUT. A temperature value can be assigned to this loss using the **Before Temp**. Using the *Cold* temperature of the noise source (often assumed to be 290 Kelvin) corrects for this, and the analyzer will give corrected results comparable to those that would have been given by an SSB measurement.

DSB measurements are not appropriate for making measurements where DUT performance, or noise source ENR, have significant variation over the frequency range $[F_{LO} \pm F_{IF}]$.

DSB measurements need care to determine their filtering needs.

NOTE

When making a Double Side Band (**DSB**) measurement with **RF DUT Input** Frequency Context, the frequencies you specify as the RF Start and RF Stop frequencies refer to the Lower Side Band only.

LO Leakage (with specific DSB information)

LO leakage is a problem when working in the 200 kHz to 3 GHz range. It can be avoided by tuning the LO to frequencies greater than 3.5 GHz. Above 3.0 GHz, the analyzer's input filter progressively attenuates the LO signal. For a DSB downconverter measurement with the LO frequency below about 3.5 GHz, a lowpass filter will be needed. The cutoff frequency must be chosen to pass the IF frequency of the measurement. The amount of attenuation over the LO frequency range has to be sufficient to reduce the LO leakage down to the broad-band (10.0 MHz - 3 GHz) noise level presented to the analyzer input.

With most DSB Downconverter measurements, the IF is made low, with respect to, the RF and LO frequencies, so filter needs are not complex.

NOTE

Low pass filters with cutoffs at low frequencies, may exhibit spurious resonances and leakage at low microwave frequencies. It may be necessary to use a pair of lowpass filters, one microwave, one RF, in order to assure a stopband attenuation over a wide frequency range.

LO Harmonics (with specific DSB information)

Many mixers have product pairs associated with harmonics of the LO. Depending on the mixer, these could be at a sufficient level to distort the measured noise figure results. To avoid this insert an input filter between the noise source and the DUT. A Highpass filter may also be needed in this location if signal leakage is a problem.

There is no general guidance on what filtering is needed. Each case needs individual consideration:

1. Decide the frequency ranges that have to be covered; Input, LO, and Output.
2. Calculate the frequency range that the LO harmonic modes will cover.
3. If LO harmonic related products are a problem, choose a filter to go between the noise source and the DUT, that will pass the wanted input band and stop the LO harmonic modes. If the frequency ranges are wide, the measurement may have to be split into frequency ranges with different filters for each.
4. Consider the LO frequency (and harmonics). Is a filter needed to protect the analyzer input being desensitized by LO leakage in the 0 to 3.5 GHz range?
5. Choose a filter, if necessary, to go between the DUT and the analyzer.

The analyzer can handle DSB mixer measurements when using a **Downconverter**, or when the **System Downconverter** is **On**.

Fixed LO

As the LO frequency is fixed, there is no sweep at the DUT input. This means that as the two sideband input pairs diverge, their average remains fixed. This feature can be useful for measuring a complex DUT where the effect of variation of performance of the post-mixer stage over IF frequency is of interest.

Because the LO frequency is held constant, it is the IF frequency at the analyzer input that is swept. [Figure 4-7](#) illustrates this mode.

Figure 4-7 Fixed LO Measurements

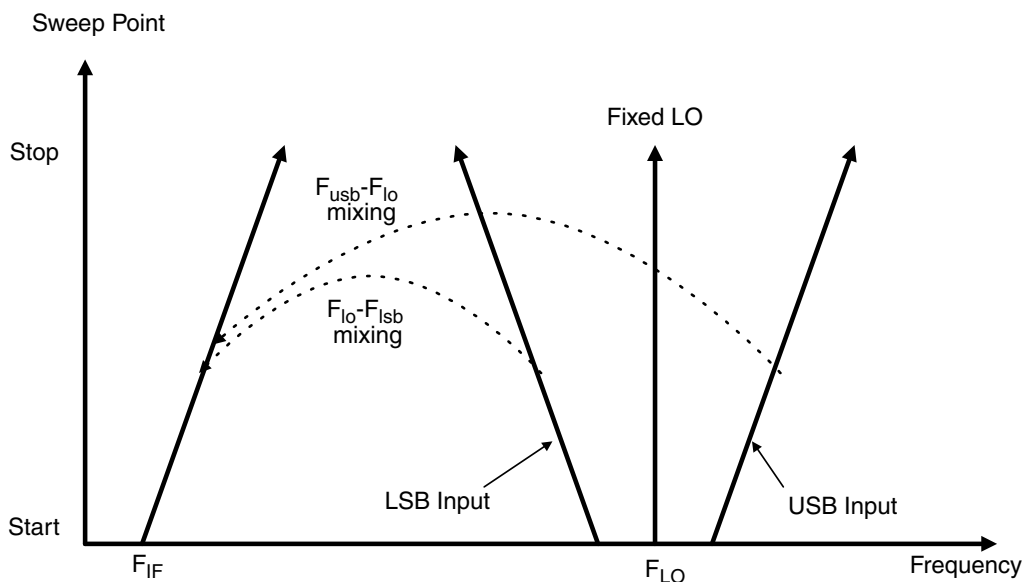

Making Frequency Converting DUT Measurements

An example is provided on the following pages using the analyzer to make a fixed frequency measurement. The LO is locked at a specified frequency, and a lower sideband (LSB) measurement of a mixer is made. The example can be modified to make measurements where the IF is swept. Also, from the example, upper and double side band measurements can be made. The changes in the example's procedure are explained in each case.

Calibration of the measurement system is similar to a basic calibration, the noise source is connected directly to the RF input of the analyzer and a calibration is made. The DUT is then placed between the noise source and the analyzer, and a corrected measurement is made.

NOTE

The RF input section on all ESA models has a built-in 3.0 GHz low pass filter. This filter needs to be accounted for when planning the filter requirements during calibration and measurement.

Making Downconverting DUT Measurements using a Fixed LO and Fixed IF (Equivalent to Mode 1.4 on an 8970B Noise Figure Analyzer)

Both double and single sideband measurements may be made in this mode. This measurement may be useful to choose the optimum IF for a mixer or receiver, or to measure how a mixer's or a receiver's noise figure and gain vary with IF.

Lower Sideband Measurement

The example lower sideband measurement is made using a ESA-E Series analyzer. A signal generator is used to supply an LO at 970 MHz. Setting the RF frequency of interest to 900 MHz, with the LO of 970 MHz gives an IF of 70 MHz. This also meets with the need to maintain the LO frequency out of the analyzer's passband.

See [Figure 4-8](#).

NOTE

In the example, a 900 MHz Band Pass Filter is used between the noise source and the DUT to remove the upper sideband. (see [Figure 4-8](#)).

A 70 MHz Band Pass Filter is used between the DUT and the analyzer to remove all signals except the 70 MHz signal in which we are interested.

Figure 4-8 Fixed LO (970 MHz) and Fixed IF (70 MHz), LSB Spectrum

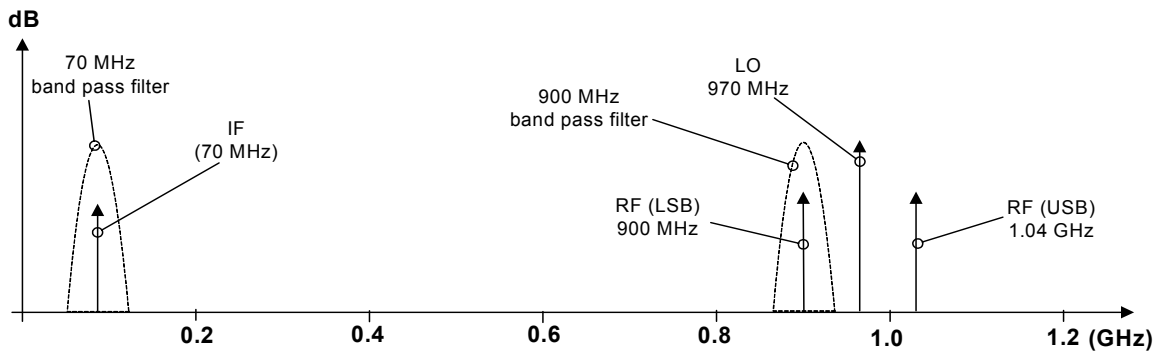

Initial Setup Procedure Follow the overview procedure of the initial set up.

- Step 1.** Power Up the analyzer and the LO. You need to wait for the recommended warm up time to get accurate measurement results
- Step 2.** Connect the 10 MHz reference, if required. [see “Connecting the System” on page 127](#) for more detail.
- Step 3.** Load the ENR values for the chosen noise source. [see “Entering Excess Noise Ratio \(ENR\) Data” on page 37](#) for more detail.
- Step 4.** Set up the LO. See [“Choosing and Setting Up the Local Oscillator” on page 125](#) for more detail.
- Step 5.** Connect the system and add filtering where required. [Figure 4-10 on page 145](#) shows the connections.

Setting Up the DUT

- Step 1.** Press the **Mode Setup** key, and the **DUT Setup...** key. The DUT Setup form is displayed ([Figure 4-9](#)). Confirm that the **DUT** field is set to **DownConv** (select the **DownConv** key to highlight it).

The default **Device Under Test** setting is **Amplifier**.

NOTE

The **System Downconverter** field is no longer accessible to you when the DUT is a downconverter.

- Step 2.** Press the **Tab** key to navigate to the **Ext LO Frequency** field. Enter the LO frequency of 970 MHz.
- Step 3.** Press the **Tab** key to navigate to the **Sideband** field. Select the lower sideband by pressing the **LSB** key.
- Step 4.** Press the **Tab** key to navigate to the **Frequency Context** field, and select **IF Analyzer Input**. This means that we will specify the frequency at the analyzer’s input (70 MHz), and the RF frequency will be calculated by

the noise figure application.

- Step 5.** Press the **Tab** key to navigate to the **Diagram** field, and select **Calibration**. This will then display the setup diagram for measurement calibration. Check that the system is setup as shown in the diagram.

NOTE In this example measurement, 70 MHz bandpass and 200 MHz low-pass filters have been used between the DUT and the analyzer. These filters have been added at this Calibration stage to remove any errors that they might contribute from the final result.

Figure 4-9 DUT Setup Form

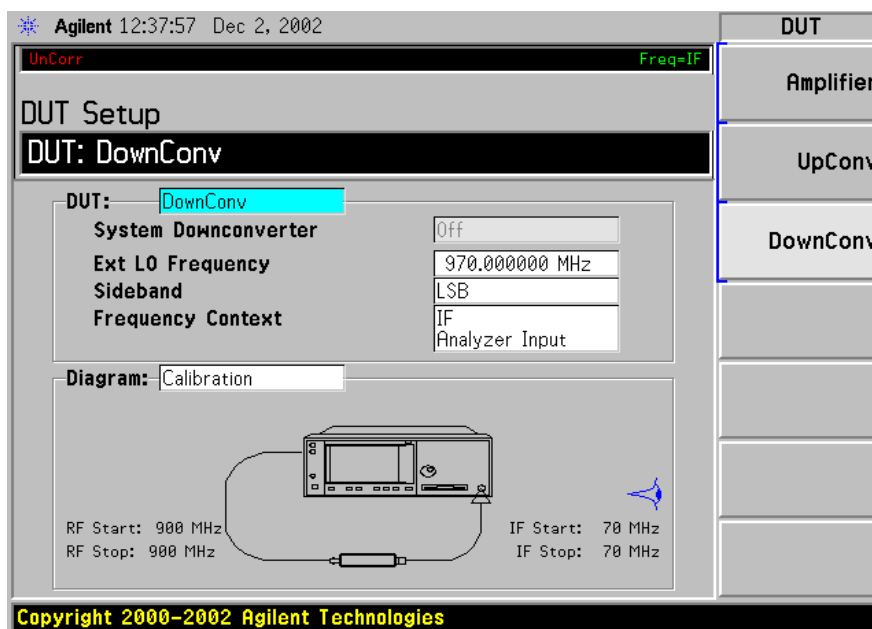

Setting Frequency, Frequency Mode, and Averaging

- Step 1.** Press the **FREQUENCY Channel** key. Use the keys presented to you specify the Frequency Mode and Frequency parameters. In this example of a fixed frequency noise figure measurement on a downconverter, the appropriate settings are
- Freq Mode: Fixed
 - Fixed Freq: 70 MHz

NOTE There are two possible frequencies you can enter - the RF frequency (before downconversion) or the IF frequency (after downconversion). In this example, we previously specified that the **Frequency Context** was **IF Analyzer Input**, so a value of 70 MHz is used

Step 2. To configure the rest of the measurement, press the **Meas Setup** key. Use the keys presented to you to specify the remaining measurement parameters. In this example, the appropriate settings are:

- Averaging: ON
- Number of averages: 10
- Internal preamp: ON

Calibration of the Measurement Setup Calibration of the setup for a noise figure measurement is specific to the frequency you have set. If you change the frequency after calibration, you will have to recalibrate the measurement.

To connect the noise source and analyzer for calibration, see [Figure 4-10](#) or [Figure 4-10](#). Connect any After DUT filtering prior to calibration.

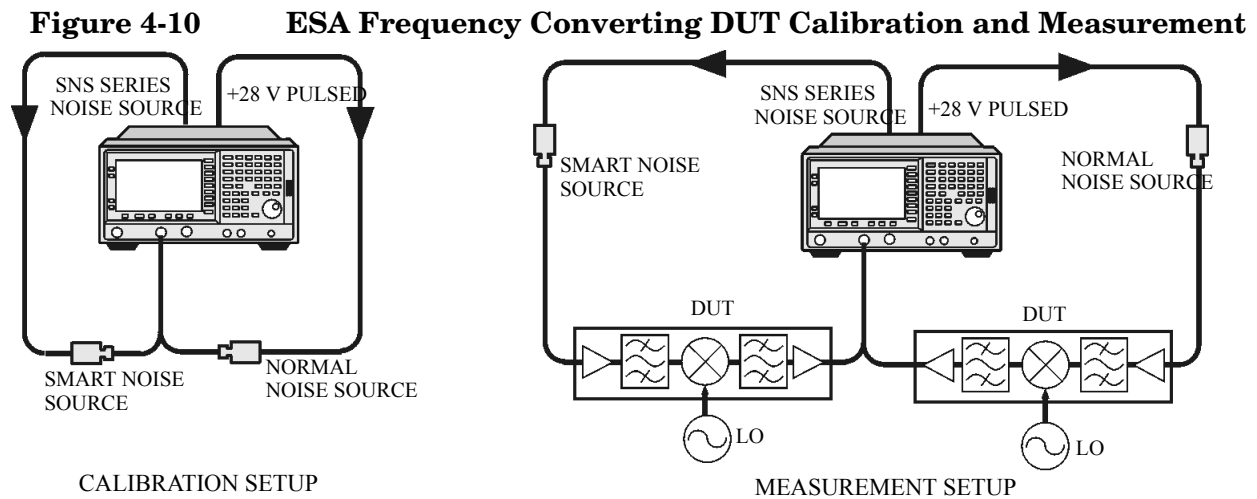

Step 1. Press the **Meas Setup** key, and the Calibrate key twice

The first time you press the **Calibrate** key you are prompted to press it again. This two-stroke calibration is a safety feature to prevent you from accidentally pressing **Calibrate** and erasing the current calibration data.

When calibration is complete the measurement system is calibrated at the mixer input. The red Uncorr text changes to green Corr text in the top right hand side of the display.

Step 2. Press the **View/Trace** key and the **Meter** key to see the calibration results.

Figure 4-11 Typical Calibration Results

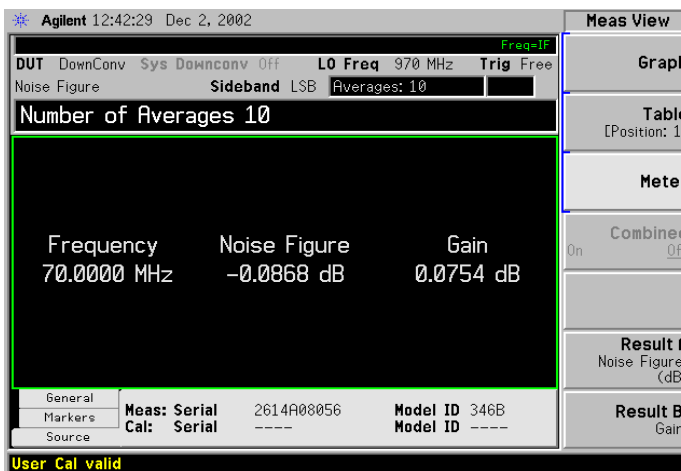

NOTE

After calibration the instrument will not be jittering near 0 dB with no DUT inserted. This is because the instrument is now using the ENR value for the RF, while the input is tuned to the IF. When DUT is added, the NFA measures the noise figure of the DUT. If the configuration is arranged to reject one sideband, the SSB result is displayed. If both sidebands are converted by the mixer the DSB result is displayed.

Making the Corrected Noise Figure and Gain Measurement A measurement corrected for the noise contributed by the analyzer may now be made. Insert the DUT into the system as shown in [Figure 4-10](#). Press the **View/Trace** key and the **Meter** key to display the results. A typical display of noise figure and gain (conversion loss) is shown in [Figure 4-12](#).

NOTE

The filtering used for this example measurement comprised:

- 900 MHz bandpass filter between the noise source and the DUT
- 70 MHz bandpass and 200 MHz low-pass filters between the DUT and the analyzer

Figure 4-12 Typical Microwave Results

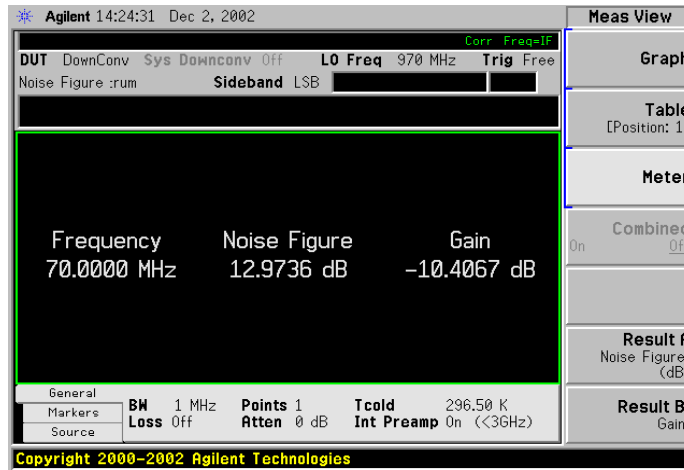

NOTE Once you have successfully made the measurement you may want to save the set up for future measurements. This can be done by saving the state. For more details, see the ESA Series User’s/Programmer’s Guide.

Upper Sideband Measurement

The upper sideband measurement set up is similar to the LSB measurement procedure described in “[Lower Sideband Measurement](#)” on page 142. However, the filtering requirements will be different because the LSB has to be filtered out. Follow the LSB procedure, and in the **DUT Setup...** form select **USB** in the sideband option.

Double Sideband Measurement

The double sideband measurement set up is similar to the LSB measurement procedure described in “[Lower Sideband Measurement](#)” on page 142. Follow the LSB procedure, and in the **DUT Setup...** form select the **DSB** in the sideband option.

If the assumptions about the parameters being flat over frequency between the two sidebands are valid, your results will show a doubling in power (3 dB increase) in noise level during a DSB measurement. This can be corrected using the Loss Compensation Setup screen (**Input/Output, Loss Comp**). Set **Loss Compensation Before DUT** to **Fixed**, enter a **Fixed Value** of -3 dB, and set **Temperature** to the noise source’s cold temperature. The DSB power addition occurs for both the *Hot* and *Cold* noise from the noise source, and the noise created in the input of the DUT. A temperature value can be assigned to this loss using the **Before Temp**. Using the *Cold* temperature of the noise source (often assumed to be 290 Kelvin) corrects for this, and the analyzer will give corrected results comparable to those that would have been given by an SSB measurement.

Making Upconverting DUT Measurements using a Fixed LO and Variable IF (Equivalent to Mode 1.4 with SUM on an 8970B Noise Figure Meter)

Lower Sideband Measurement

The lower sideband measurement set up is similar to the LSB measurement procedure described in “[Lower Sideband Measurement](#)” on page 142. However, with an upconverting measurement, the RF is the lower frequency, and the IF is the higher frequency to which you will convert. Follow the LSB procedure, and in the **DUT Setup...** form ensure the **LSB** is the sideband option is selected, and select **Upconv** instead of **Downconv** as the DUT. The filtering requirements will be different as you need to remove the LO signal from the IF path.

Upper Sideband Measurement

The upper sideband measurement set up is similar to the LSB measurement procedure described in “[Lower Sideband Measurement](#)” on page 142. However, with an upconverting measurement, the RF is the lower frequency, and the IF is the higher frequency to which you will convert. Follow the LSB procedure, and in the **DUT Setup...** form ensure the **LSB** is the sideband option is selected, and select **Upconv** instead of **Downconv** as the DUT. The filtering requirements will be different as you need to remove the LO signal from the IF path.

Measurements with a System Downconverter

A system downconverter can be thought of as a frequency extender for the analyzer, to allow measurements to be made on DUTs at frequencies the analyzer does not cover in its frequency range.

NOTE This measurement discussion uses an unspecified external downconverter. So there are no warranted specifications or characteristics provided for the measurement system.

Figure 4-13 ESA System Downconverter Calibration and Measurement

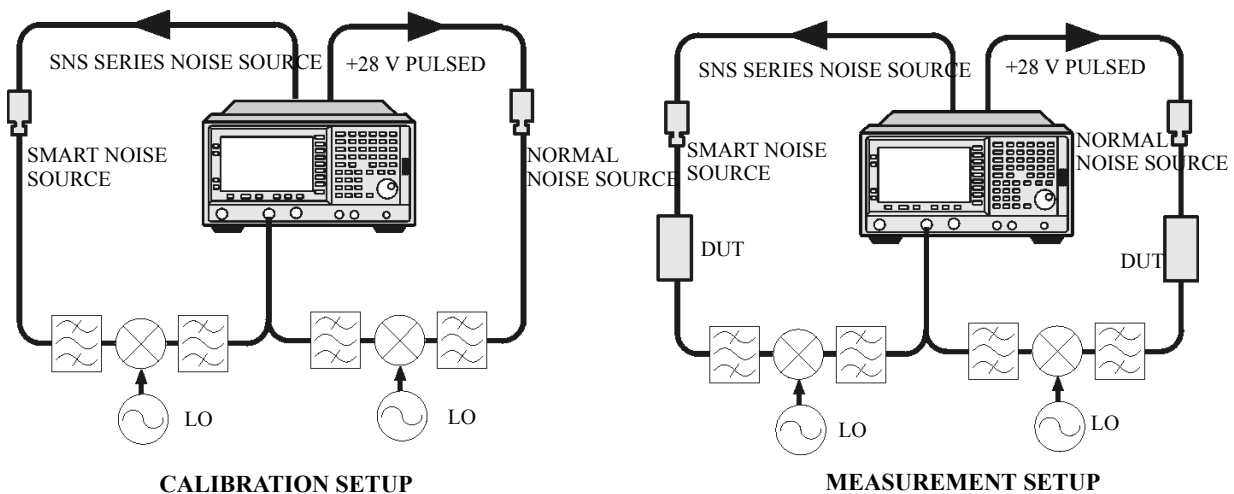

A system downconverter is part of the measuring system, and is present in both the calibration setup and the measurement setup (see [Figure 4-13](#)). During calibration, the noise performance of both the analyzer and the system downconverter are measured. Because of this, when corrected measurements are performed, the results then apply to the DUT only. ENR data for the same frequency range is used for both calibration and measurements

The analyzer has the capability to control a single frequency conversion, so system downconverter measurements under the analyzer's control are limited to non-frequency converting DUTs.

The analyzer can be used in much more complex systems, with multiple frequency conversions between the DUT and measurement system. However, the control of such systems is application-specific. You need to perform frequency calculations to suit that particular system, account for the effects of any DSB conversions, determine filter requirements, and calculate the appropriate ENR values for calibration and measurement.

USB, LSB or DSB?

If the DUT is broad-band, a system downconverter could operate in USB, LSB, or DSB mode, and the same circumstances occur in both calibration and measurements, hence DSB sideband power addition corrections are not needed. Corrected measurements cancel any sideband summation effects.

If the DUT is narrowband and a DSB system downconverter is used, the calibration setup will operate in true DSB mode. However, the measurement setup mode will be influenced by the DUT's selectivity.

The possibilities fit into two groups and a third situation which should be avoided:

1. The DUT bandwidth is much greater than the LSB-USB separation, so a normal DSB measurement results.
2. The DUT bandwidth is much less than the LSB-USB separation, and the sweep width is less than the USB-LSB separation, so an SSB measurement results. This needs a gain correction factor due to the DSB calibration

NOTE

There is a third situation and this must be avoided. This is where the DUT selectivity can resolve the individual sidebands of the DSB measurement and the sweep is wide enough to scan the DUT across them. Different parts of the measurement plot are in different modes. USB, LSB and DSB could occur in different places on the same plot, with gradual changes between them, set by the shape of the DUT's frequency response. Variable gain correction would be needed across the plot and the corrections needed would change if adjustments to the DUT changed its shape.

Measurement Modes with a DSB System Downconverter

The ESA-E series of analyzers only support the use of a fixed LO, with any frequency sweeping being done by the analyzer. The benefits of a DSB measurement are minimal filter requirements, and wide frequency coverage. DSB measurements are appropriate for wideband DUTs. Their disadvantages, covered in the “USB, LSB or DSB?” section, make them inappropriate for narrowband DUTs. The usual aim is to choose as low a frequency IF as possible, in order to minimize the separation between the sidebands, and thus get the optimum resolution possible. [Figure 4-14](#) shows this.

NOTE

When making Double Sideband (**DSB**) measurements, it is important that the IF frequency is much smaller than the LO frequency. This is because the ENR values in the ENR table can only be applied to one frequency or, in the case of a swept measurement, to one set of

frequencies. The ENR values can not be applied simultaneously to both the upper sideband and to the lower sideband. The ENR values are therefore applied to the midpoint between the upper sideband and the lower sideband, and this equates to the LO frequency.

Consequently, the higher the IF frequency is in comparison to the LO frequency, the further apart the upper and lower sidebands will be. The further these upper and lower sidebands are from the LO frequency, the less accurate will the ENR value be.

Another potential source of error is the frequency response of the DUT. If the frequency response varies over the measurement range, from lower to upper frequency, the noise figure results will only represent an average value.

It is recommended for greatest accuracy that the IF frequency be no greater than 1% of the LO frequency when making double sideband measurements. When making a swept measurement, no frequency in the swept frequency band should exceed 1% of the LO frequency.

Figure 4-14 DSB System Downconverter Measurements

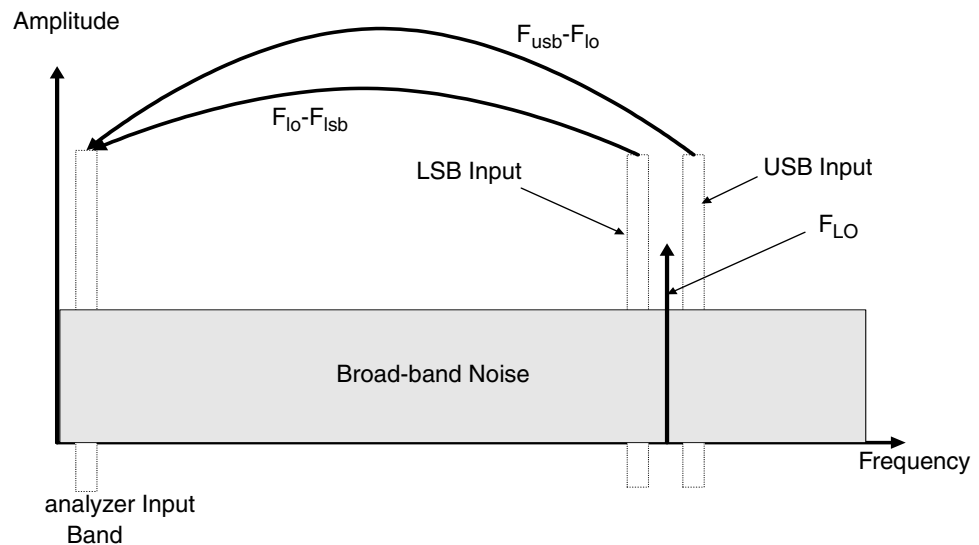

DSB system downconverter measurements have implicit linear averaging of DUT characteristics. The same ENR values are used for both the USB and LSB frequencies, and are taken from the average frequencies of the USB and the LSB. This corresponds to the LO frequency. Results returned are the average of the two sideband powers.

For microwave measurements, above 3.5 GHz, the analyzer's input filter will reject LO leakage from the downconverter, otherwise a filter is needed between the system downconverter and the analyzer. Also,

considerations about mixer LO harmonic modes apply.

Measurement Modes with an SSB System Downconverter

The analyzer can perform frequency calculations for USB, for LSB, or for USB system downconverter conversions.

The filtering requirements will be measurement-specific.

Figure 4-15 shows how filtering makes an LSB measurement, and Figure 4-16 shows a USB downconversion measurement.

Figure 4-15 LSB System Downconverter Measurements

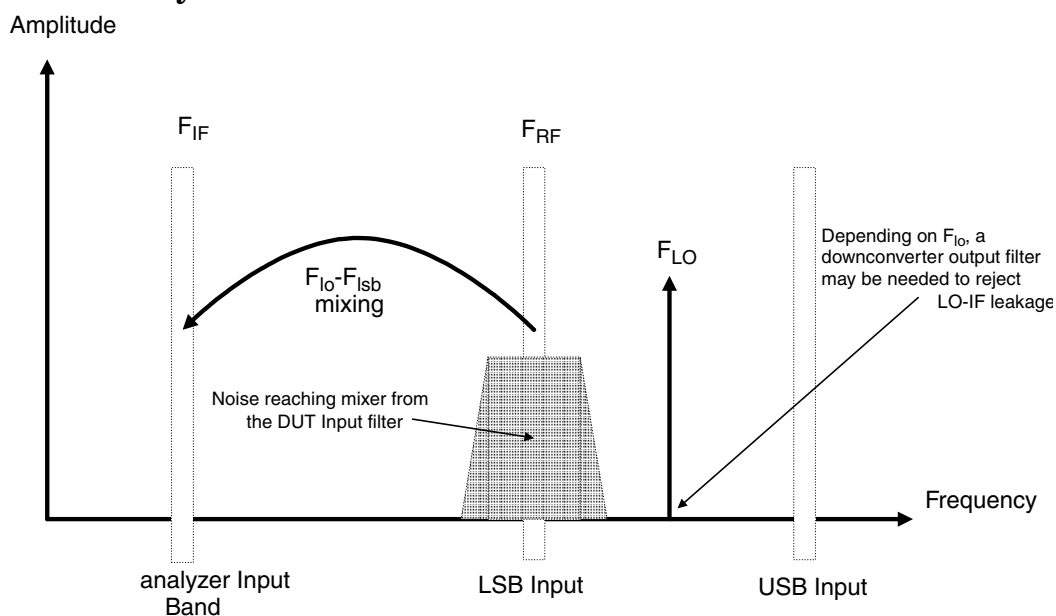
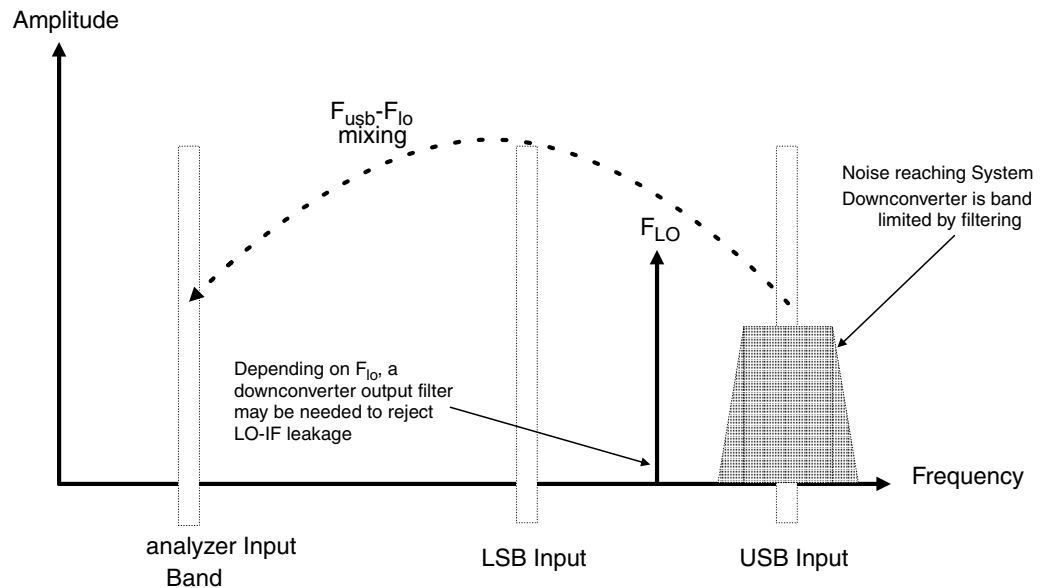

Figure 4-16 USB System Downconverter Measurements



Ideally choose a high IF frequency for the conversion to separate the USB and LSB bands, thus simplifying the filter requirements.

The filter needed to make an SSB measurement could be part of the DUT, or a measurement-specific filter must be obtained and applied at the input to the system downconverter.

The bandwidth of the SSB filter limits the maximum frequency range over which a measurement can be swept. Therefore SSB measurements are not suited to very wideband DUTs.

Filtering is needed to select the wanted sideband. A swept noise figure measurement is then possible even if the LO cannot be swept.

FIXED LO, LSB

The main benefit of the fixed LO system downconverter modes is that a programmable synthesized LO is not needed.

Figure 4-17 LSB Measurements

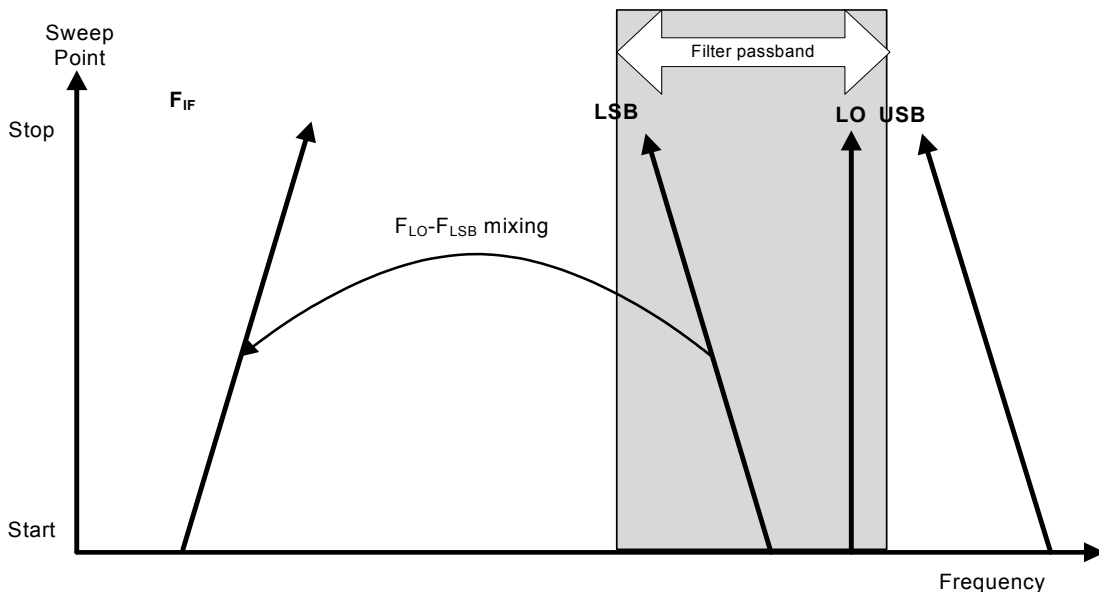

Figure 4-17 shows how the analyzer sweeps its own input frequency so that as the LSB tunes, the frequency increases across the sweep. The filter required is either a lowpass or a bandpass. The maximum sweep width is now limited to the maximum IF frequency, less an allowance for the filter transition band.

FIXED LO, USB

Figure 4-18 USB Measurements

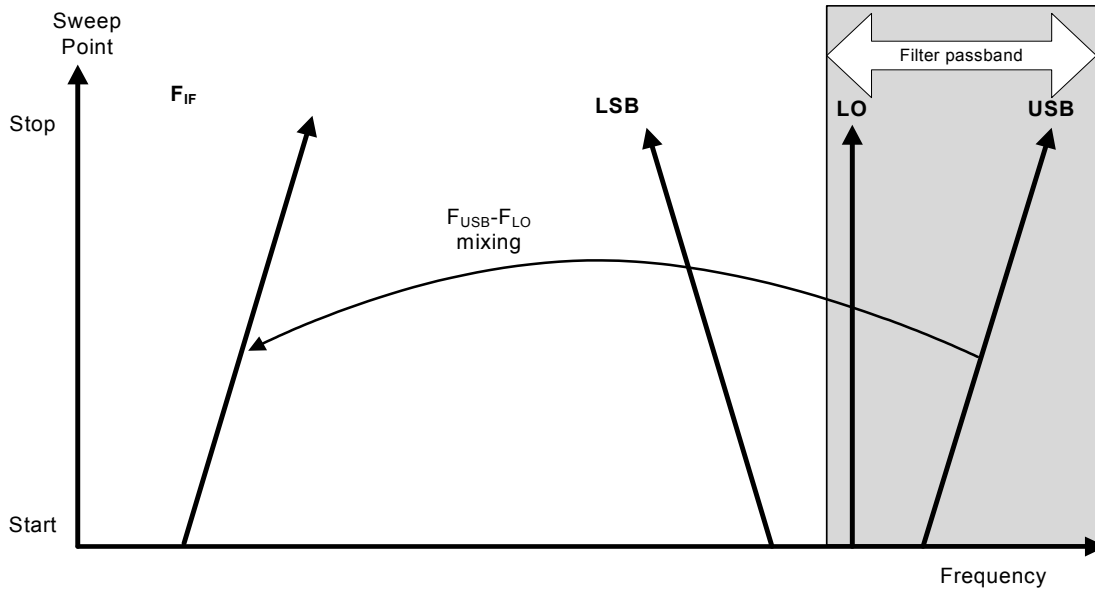

Figure 4-18 shows that as the analyzer is tuned in the normal direction, that is, from a low frequency to a high frequency, the USB and the IF vary in unison. The filter can be a bandpass or highpass, and the sweep width is again limited to the maximum IF frequency, less an allowance for the filter transition band.

Frequency Restrictions

To assist you in troubleshooting problems that you may have encountered when setting up these measurement modes, the restrictions that apply to the different types of measurements are detailed on the following pages.

NOTE

The analyzer will only return messages if the frequencies used at the ports of the frequency converter fall outside the valid range that the analyzer can handle. Under such conditions, a valid measurement cannot be performed. Within these limits, it is up to you to specify valid frequencies at all ports for the type of DUT currently selected.

Glossary of Restricted Terms

Table 4-2 is a description of the terms used in the restrictions

Table 4-2 Restricted Terms

Term	Description
IF	The output from DUT frequency or the tuned frequency of the analyzer
IF _{START}	IF Start frequency. IF _{START} is lower than IF _{STOP} .
IF _{STOP}	IF Stop frequency. IF _{STOP} is higher than IF _{START} .
RF	The input to DUT frequencies
RF _{START}	RF Start frequency. RF _{START} is lower than RF _{STOP} .
RF _{STOP}	RF Stop frequency. RF _{STOP} is higher than RF _{START} .
F _{LO}	External LO

General Restrictions

In noise figure measurements, the following general restrictions apply:

- The IF frequency range is limited to a minimum of 10 kHz, and a maximum of your analyzer's maximum frequency. This maximum frequency is dependent on the model of analyzer.
- The RF frequency range is from 1 Hz to 325 GHz, depending on the DUT setup.

NOTE

Regardless of whether the input frequencies are RF frequencies or IF frequencies, the Frequency/Channel menu is used to enter these frequency values.

- The minimum frequency separation between consecutive points is 10 Hz.

Frequency Downconverting DUT

In this measurement, the DUT contains a frequency downconverting device. Two examples are a mixer or receiver. These are the applicable restrictions:

LSB Restrictions

With LSB measurements, the following restrictions apply:

- $RF_{STOP} < F_{LO}$
- $RF_{START} > IF_{STOP}$
- $F_{LO} - RF_{STOP} \geq 10 \text{ kHz}$

USB Restrictions

With USB measurements, the following restrictions apply:

- $RF_{START} > F_{LO}$
- $IF_{STOP} < F_{LO}$
- $RF_{START} - F_{LO} \geq 10 \text{ kHz}$

DSB Restrictions

With DSB measurements, the following restrictions apply:

- $RF_{START} > IF_{STOP}$

Frequency Upconverting DUT

In this measurement, the DUT contains a frequency upconverting device. One example is a mixer used in a transmitter.

LSB Restrictions

With LSB measurements, following restrictions apply:

- $IF_{STOP} < F_{LO}$
- $IF_{START} > RF_{STOP}$

USB Restrictions

With USB measurements, the following restrictions apply:

- $IF_{START} > F_{LO}$
- $RF_{STOP} < F_{LO}$

System Downconverter

The DUT is a non-frequency converting device, for example an amplifier or filter measurement, and its frequency is outside the analyzer's measurement range or outside its range of maximum accuracy. Frequency downconversion is required within the measurement system, in other words, using a mixer, external to the DUT, to convert the signal of interest to the frequency range of the analyzer.

LSB Restrictions

With LSB measurements, the following restrictions apply:

- $RF_{STOP} < F_{LO}$
- $RF_{START} > IF_{STOP}$
- $F_{LO} - RF_{STOP} \geq 10 \text{ kHz}$

USB Restrictions

With USB measurements, the following restrictions apply:

- $RF_{START} > F_{LO}$
- $IF_{STOP} < F_{LO}$
- $RF_{START} - F_{LO} \geq 10 \text{ kHz}$

DSB Restrictions

With DSB measurements, the following restrictions apply:

- $RF_{START} > IF_{STOP}$

5 Menu Maps

This chapter provides a visual representation of the front-panel keys and their associated menu keys. Refer to [Chapter 6](#), “[Front-Panel Key Reference](#),” on page 195 for descriptions of the key functions.

What You Will Find in This Chapter

This chapter provides menu maps for the front panel keys that have menus associated with them. The key menus are listed in alphabetical order.

Key to this chapter's menumap diagrams

In this chapter of menumap diagrams, the following key has been used:

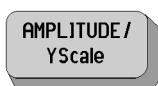

This represents a hardkey, that is, a raised key on the front panel.



This represents a softkey on a menu, that is, a key that is displayed only on the screen



A bar on the left of two or more keys indicates that the keys are a set of mutually exclusive choices.



A dagger to the left of the key indicates that this is an active function.



A double-dagger to the left of the key indicates a function that is not always available. It is dependent on other instrument settings.



This symbol to the left of the key indicates a function that is only available on the PSA series of analyzers.



This symbol to the left of the key indicates a function that is only available on the ESA-E series of analyzers.

Menus

Amplitude Menu - Monitor Spectrum Measurement

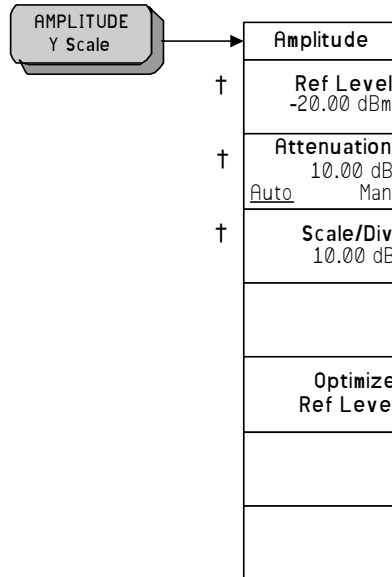

† A dagger to the left of the key indicates that this is an active function.

Amplitude Menu - Noise Figure Measurement

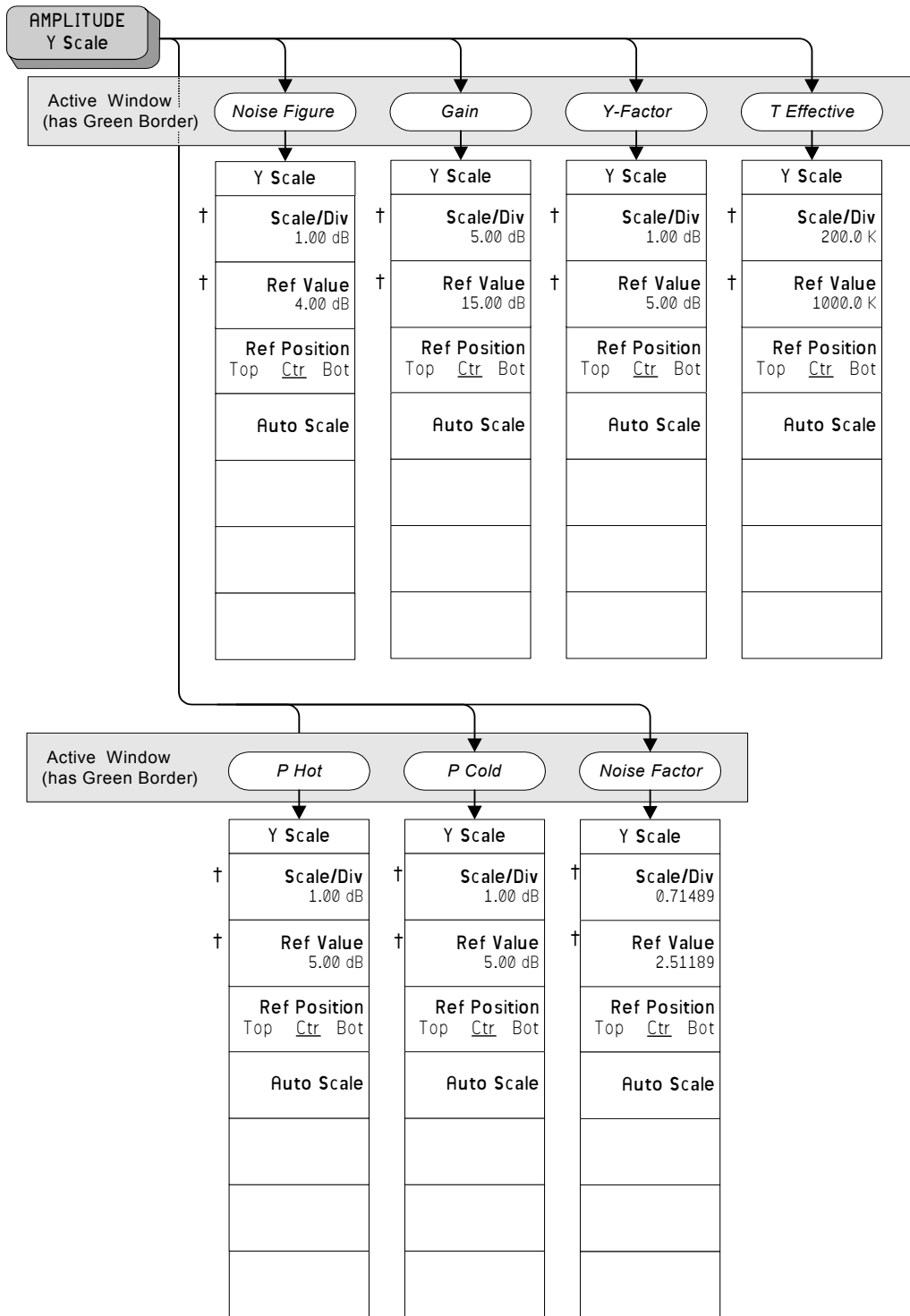

BW/Avg Menu - Monitor Spectrum Measurement

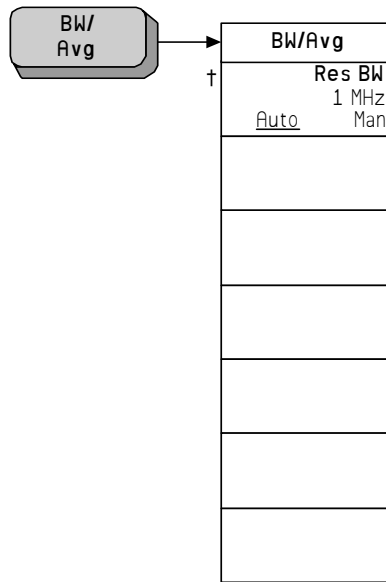

† A dagger to the left of the key indicates that this is an active function.

BW/Avg Menu - Noise Figure Measurement

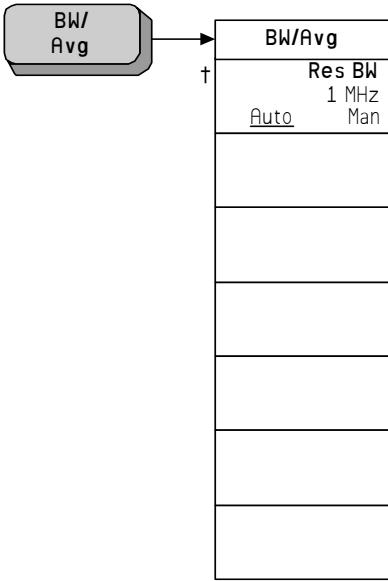

† A dagger to the left of the key indicates that this is an active function.

Det/Demod Menu - Monitor Spectrum Measurement

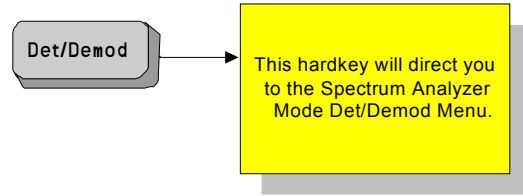

Det/Demod Menu - Noise Figure Measurement



‡ A double-dagger to the left of the key indicates a function that is not always available. In this case, the 'Detector' softkey is always grayed out and unavailable for selection.

Display Menus - Monitor Spectrum Measurement

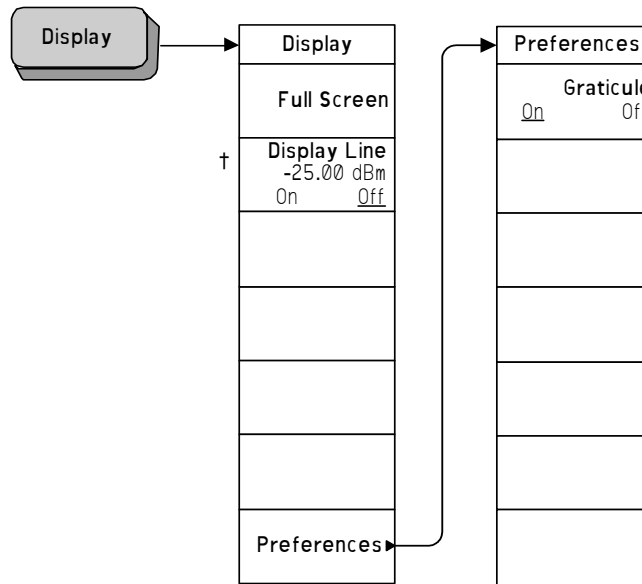

† A dagger to the left of the key indicates that this is an active function.

Display Menu - Noise Figure Measurement

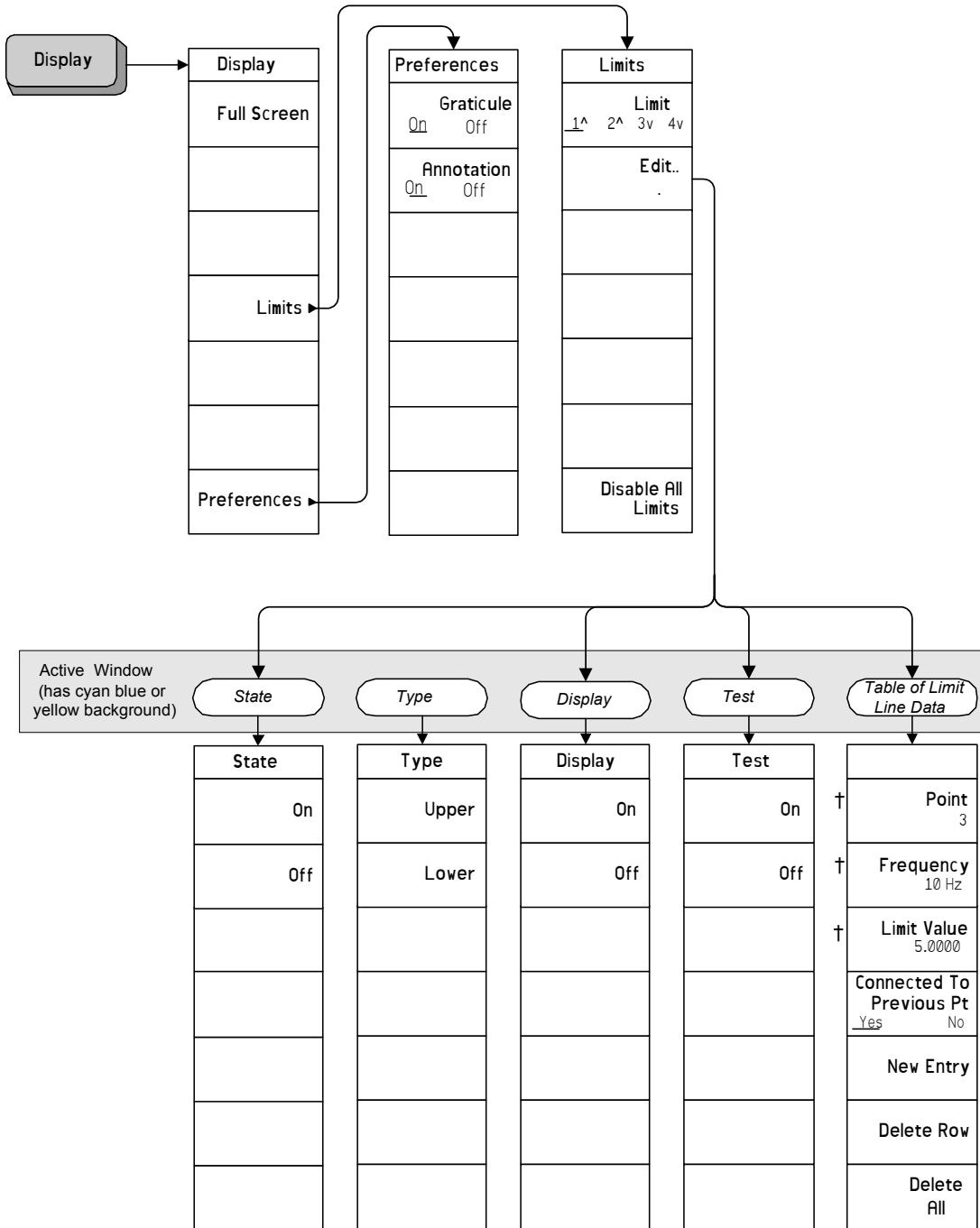

† A dagger to the left of the key indicates that this is an active function.

File Type Menu - Monitor Spectrum Measurement

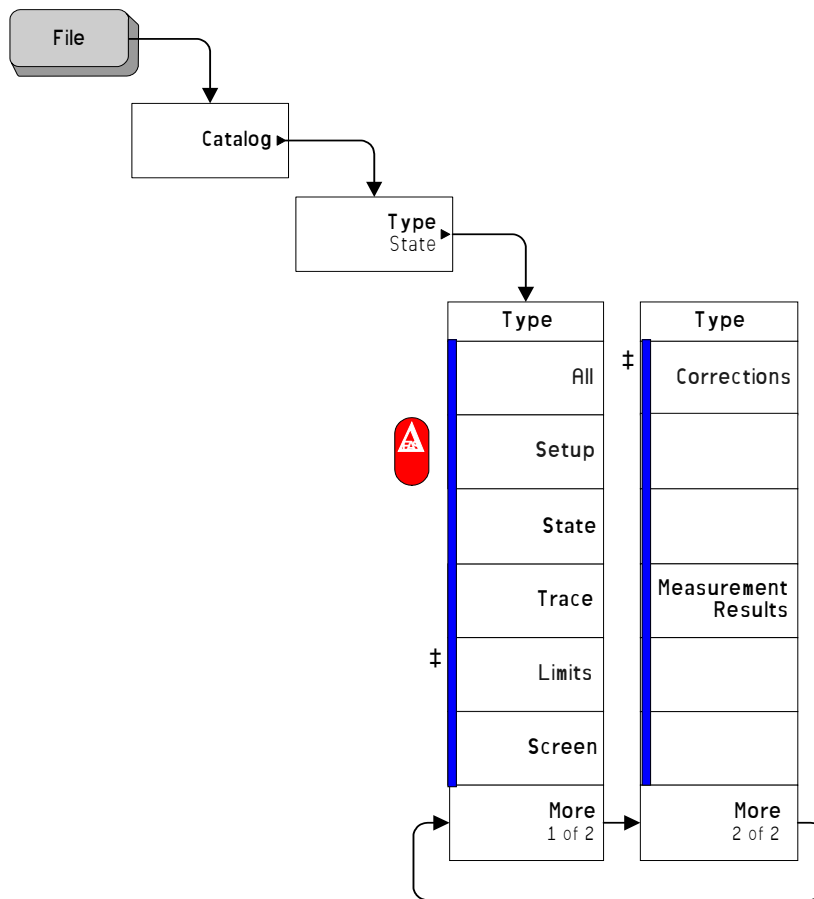

■ A bar on the left of two or more keys indicates that the keys are a set of mutually exclusive choices.

‡ A double-dagger to the left of the key indicates a function that is not always available. It is dependent on other instrument settings.

⚠
ESA This symbol to the left of the key indicates a function that is only available on the ESA-E series of analyzers.

File Type Menu - Noise Figure Measurement (ESA only)

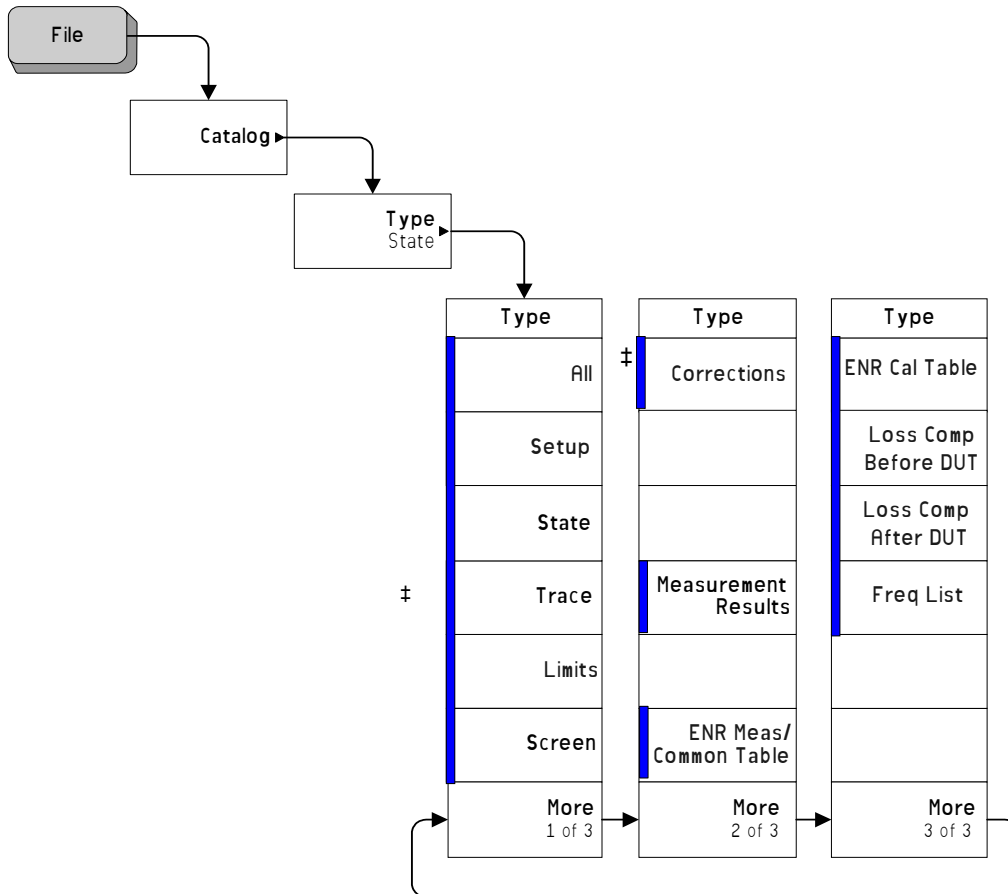

■ A bar on the left of two or more keys indicates that the keys are a set of mutually exclusive choices.

† A dagger to the left of the key indicates that this is an active function.

‡ A double-dagger to the left of the key indicates a function that is not always available. It is dependent on other instrument settings.

File Type Menu - Noise Figure Measurement (PSA only)

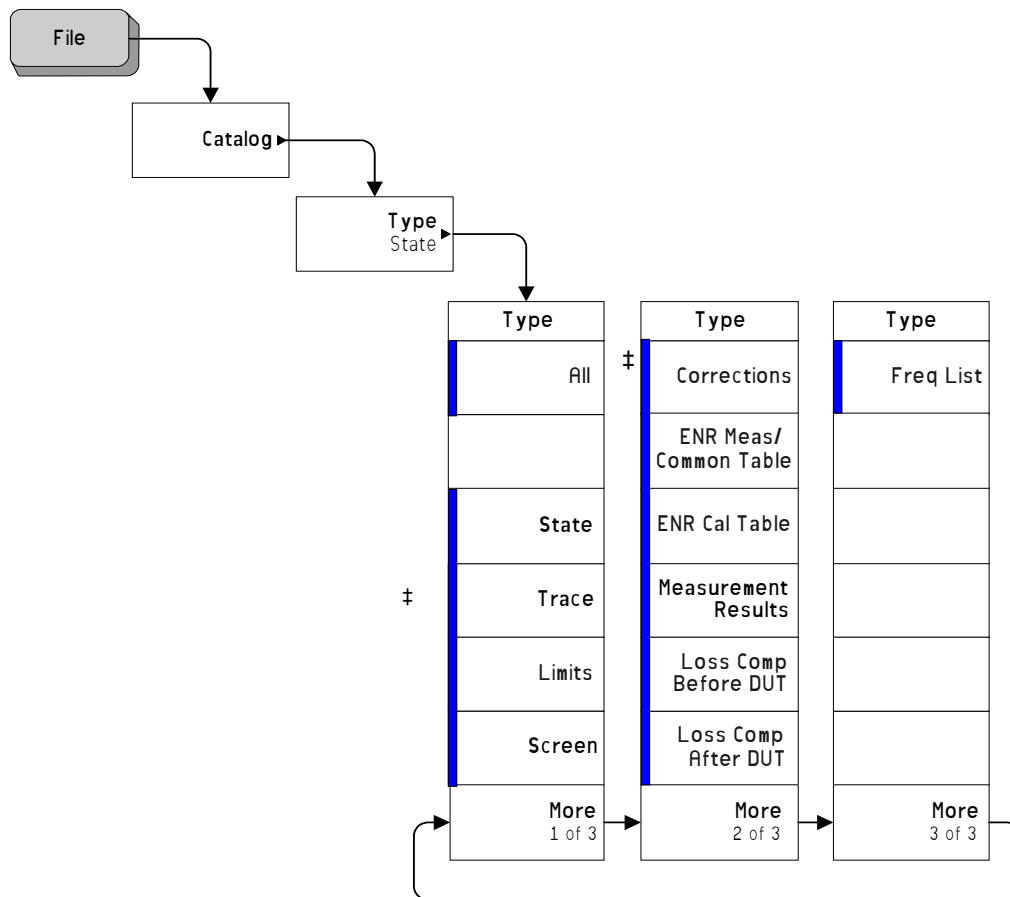

■ A bar on the left of two or more keys indicates that the keys are a set of mutually exclusive choices.

† A dagger to the left of the key indicates that this is an active function.

‡ A double-dagger to the left of the key indicates a function that is not always available. It is dependent on other instrument settings.

Frequency Menu - Monitor Spectrum Measurement

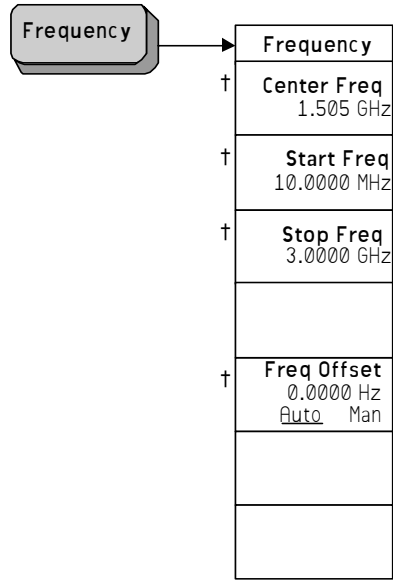

† A dagger to the left of the key indicates that this is an active function.

Frequency Menu - Noise Figure Measurement

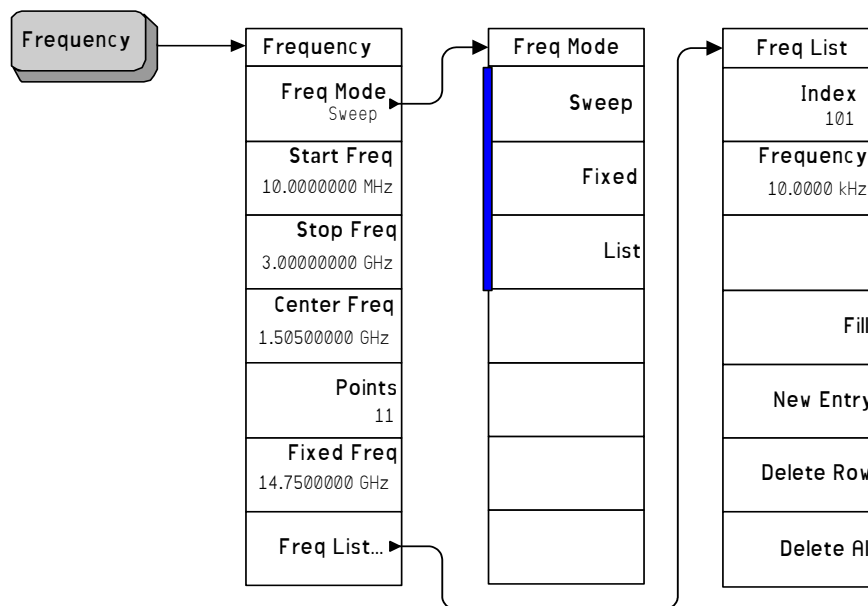

■ A bar on the left of two or more keys indicates that the keys are a set of mutually exclusive choices.

† A dagger to the left of the key indicates that this is an active function.

Input Output Menu - Monitor Spectrum Measurement

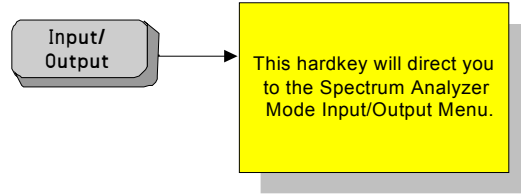

Input Output Menu - Noise Figure Measurement

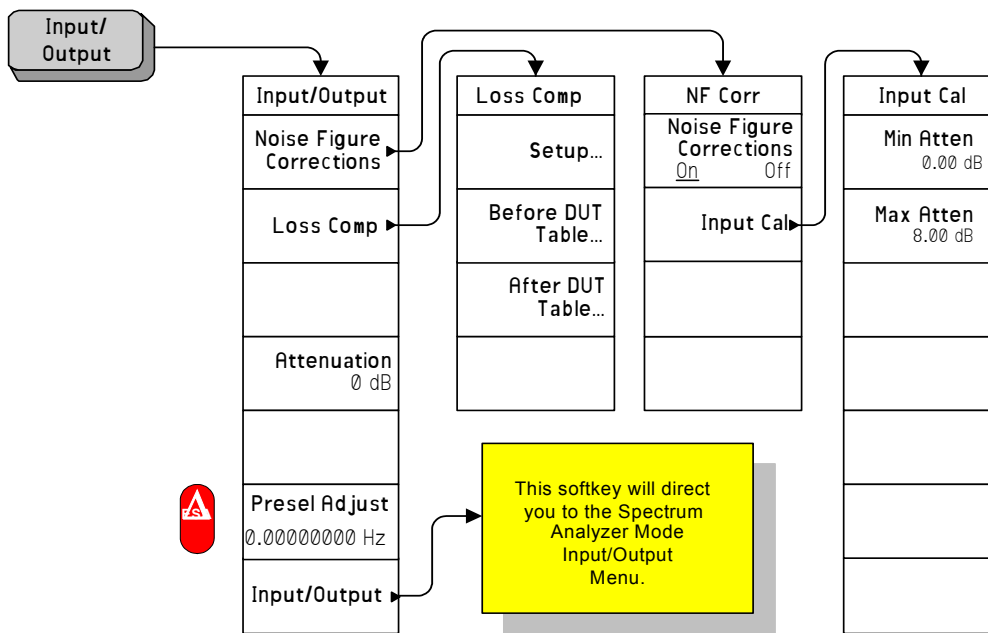

† A dagger to the left of the key indicates that this is an active function.



This symbol to the left of the key indicates a function that is only available on the ESA-E series of analyzers.

CAUTION

When you switch to DC Coupling, you risk permanently damaging the analyzer's front end mixer if the input signal contains a DC component.

Marker Menu - Monitor Spectrum Measurement

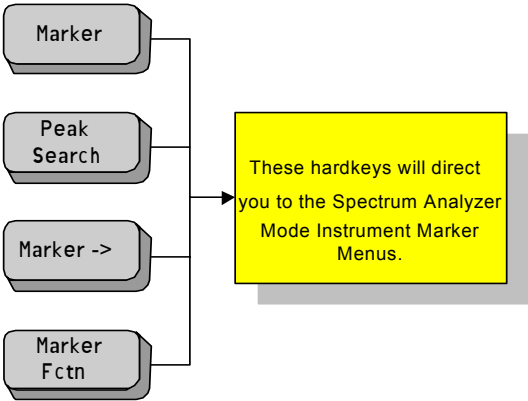

Marker Menu - Noise Figure Measurement

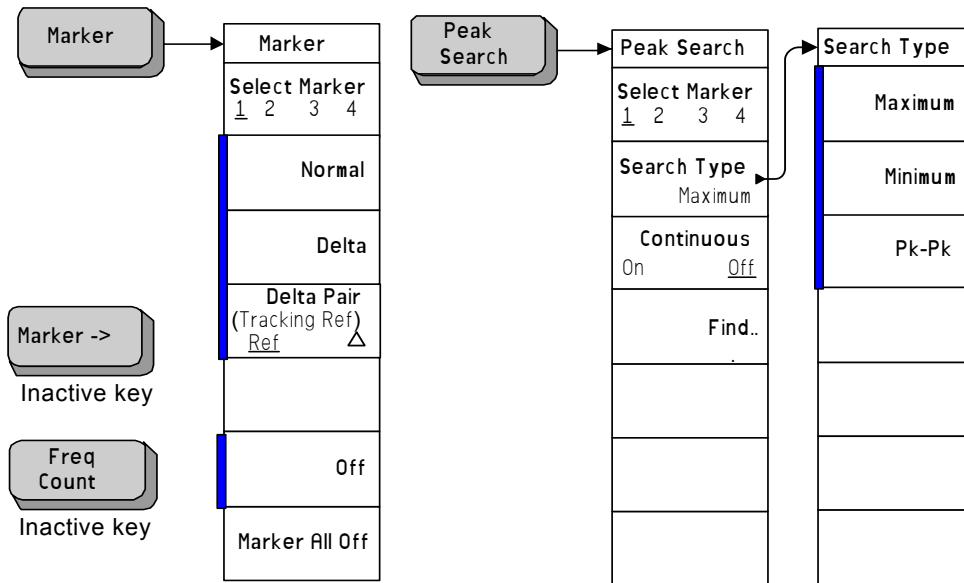

| A bar on the left of two or more keys indicates that the keys are a set of mutually exclusive choices.

Meas Setup Menu - Monitor Spectrum Measurement

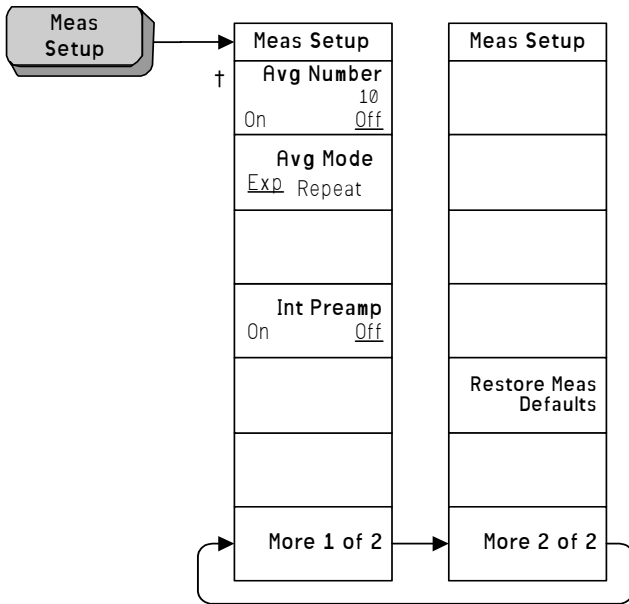

† A dagger to the left of the key indicates that this is an active function.

Meas Setup Menu - Noise Figure Measurement

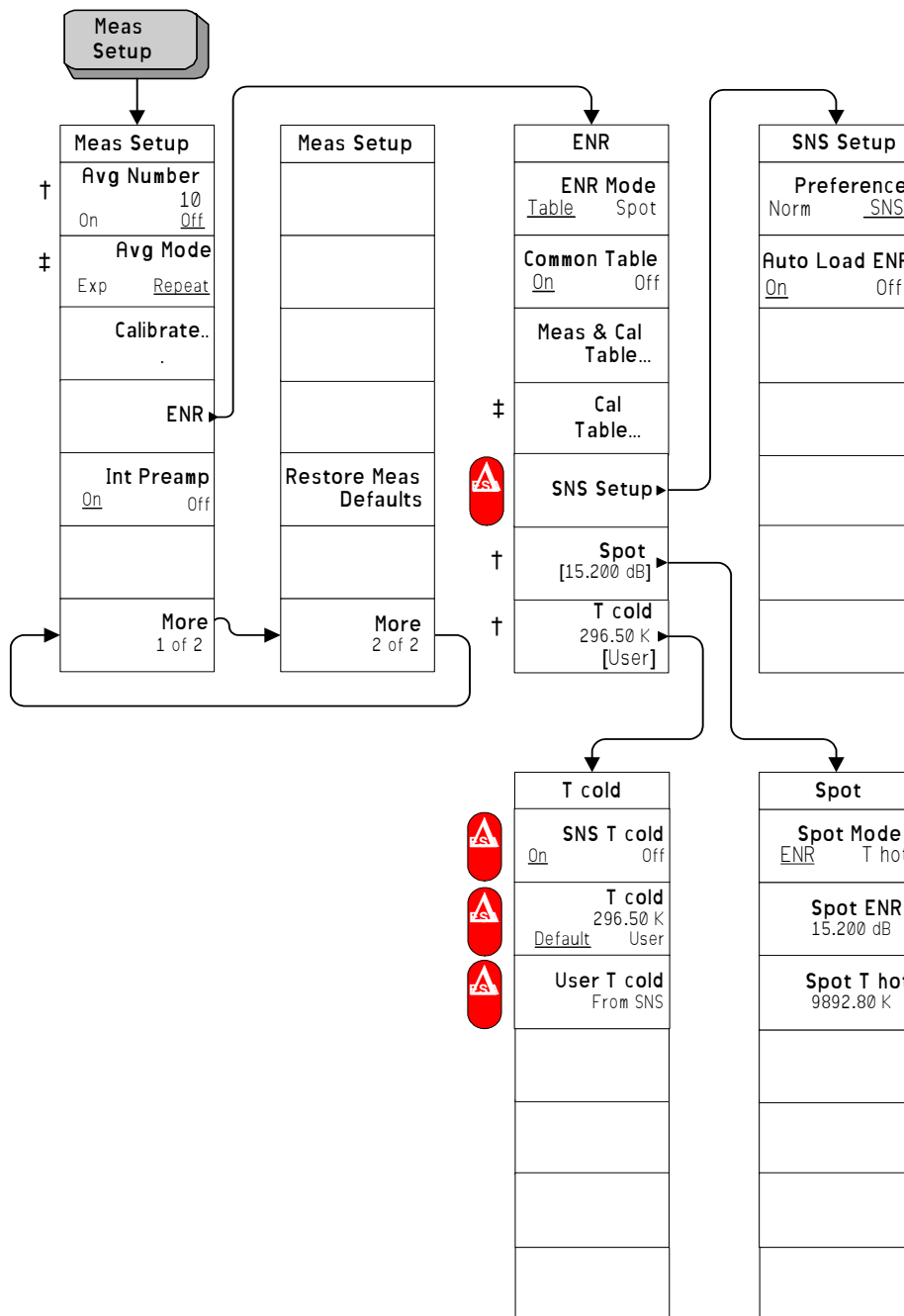

† A dagger to the left of the key indicates that this is an active function.

‡ A double-dagger to the left of the key indicates a function that is not always available. It is dependent on other instrument settings.



This symbol to the left of the key indicates a function that is only available on the ESA-E series of analyzers.

Measure Menu

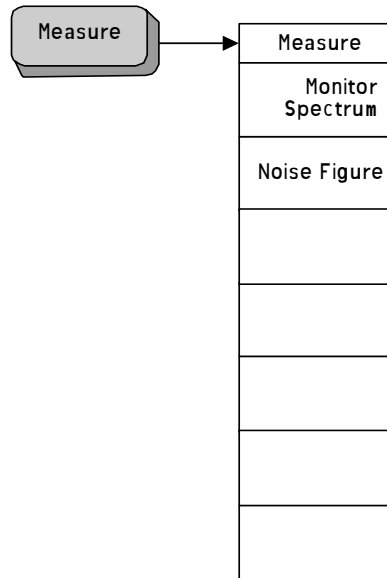

Mode Menu

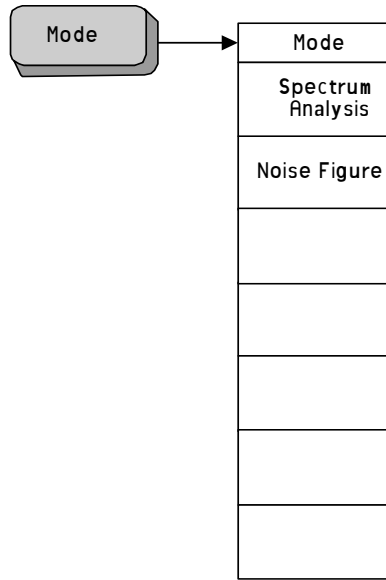

Mode Setup Menu

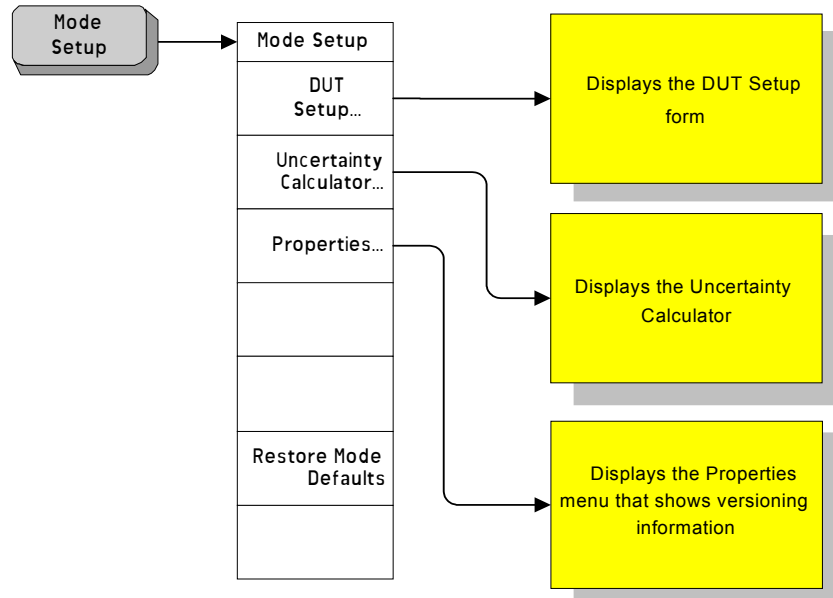

Mode Setup - DUT Setup Menu

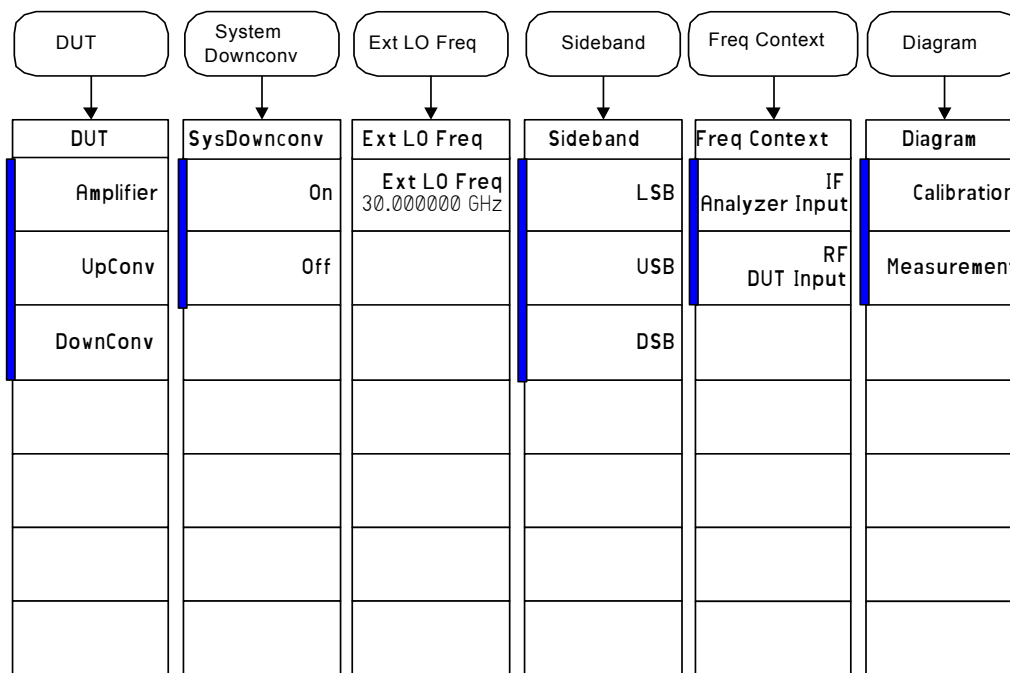

■ A bar on the left of two or more keys indicates that the keys are a set of mutually exclusive choices.

† A dagger to the left of the key indicates that this is an active function.

In the DUT Setup form represented in the diagram above, a different softkey menu is presented to you every time you Tab to a fresh field on the form. The diagram above shows the menu shown at each stage of your input. For example, when the form first displays, the cursor is in the 'DUT' field (shown above at top left), and the menu displayed to you is that shown above underneath 'DUT'. You can then Tab to the System Downconverter field, at which point the System Downconv menu (second from left) is displayed to you.

Source Menu - Noise Figure Measurement

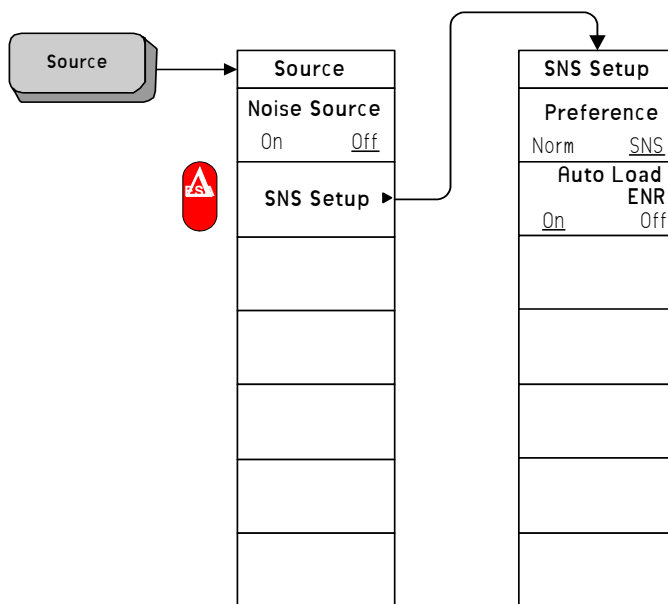

This symbol to the left of the key indicates a function that is only available on the ESA-E series of analyzers.

Span Menu - Monitor Spectrum Measurement

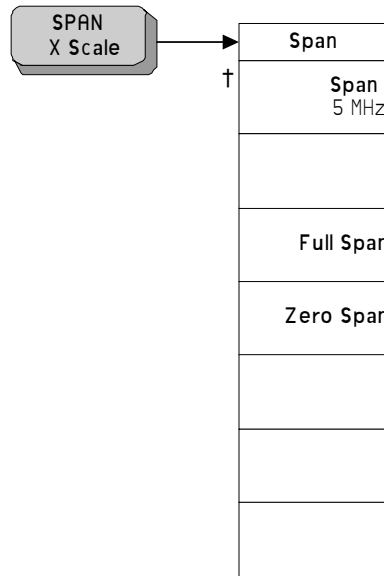

† A dagger to the left of the key indicates that this is an active function.

Span Menu - Noise Figure Measurement

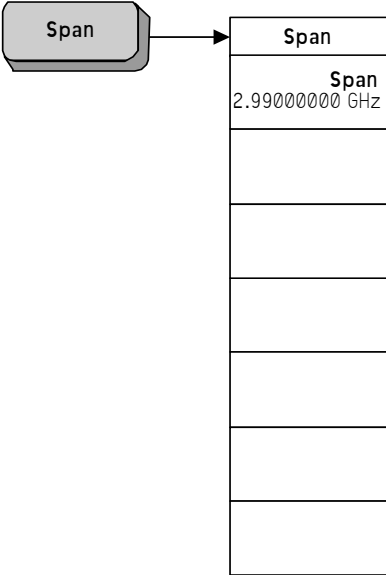

Sweep Menu - Monitor Spectrum Measurement

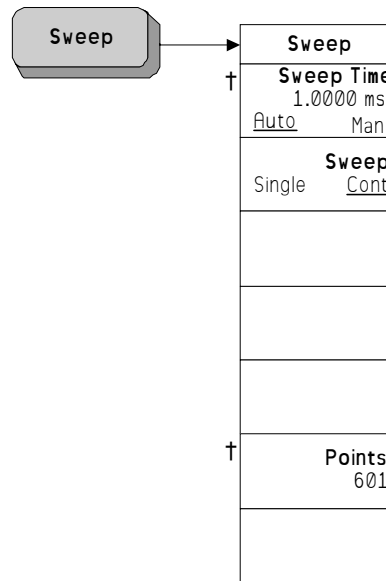

† A dagger to the left of the key indicates that this is an active function.

Sweep Menu - Noise Figure Measurement

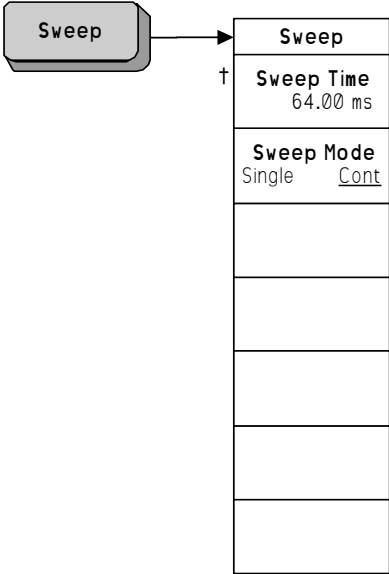

† A dagger to the left of the key indicates that this is an active function.

View/Trace Menu - Monitor Spectrum Measurement

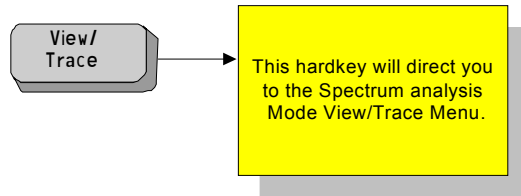

View/Trace Menu - Noise Figure Measurement

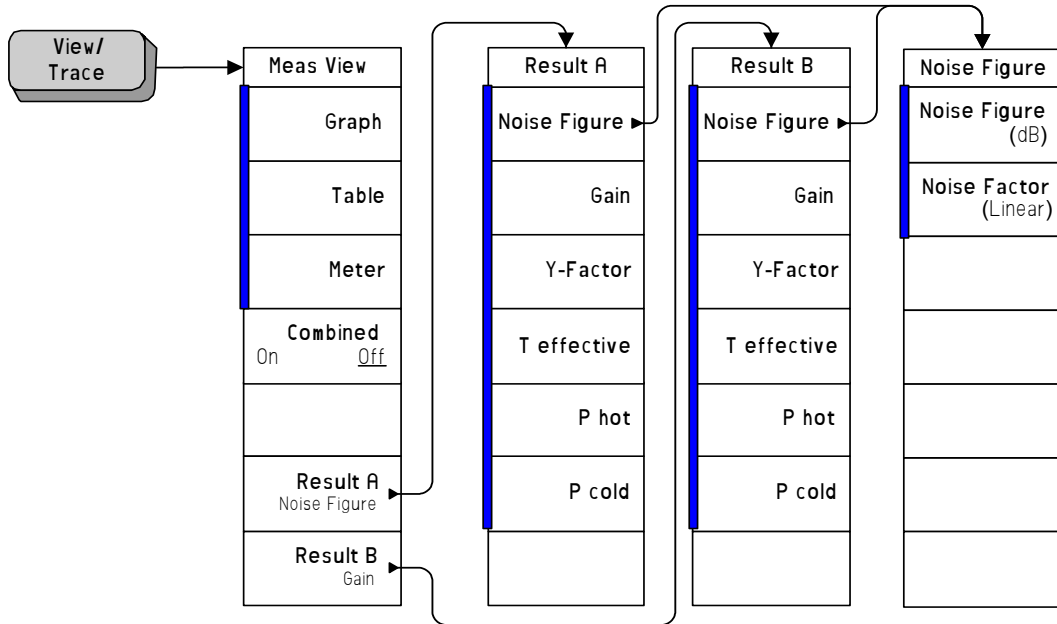

| A bar on the left of two or more keys indicates that the keys are a set of mutually exclusive choices.

Uncertainty Calculator Menus

All of these menus are all accessed from the Uncertainty Calculator screen. As you tab from field to field on the screen, you will see each of these menus displayed in sequence.

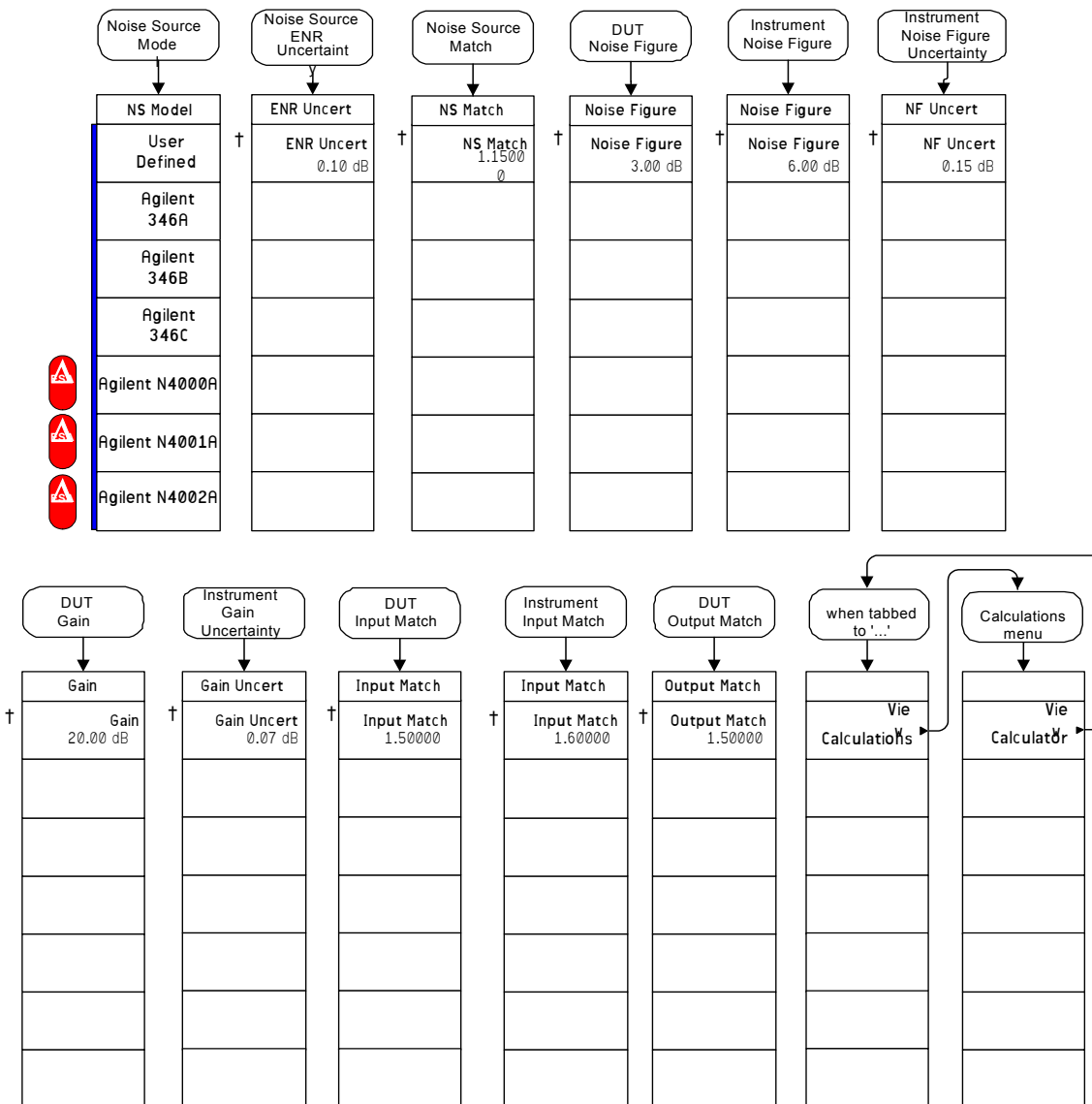

■ A bar on the left of two or more keys indicates that the keys are a set of mutually exclusive choices.

† A dagger to the left of the key indicates that this is an active function.

⚠ This symbol to the left of the key indicates a function that is only available on the ESA-E series of analyzers.

6

Front-Panel Key Reference

This chapter details the front-panel keys and menu keys that appear on the menu-maps presented in the previous chapter. The front-panel keys are listed alphabetically and are described with their associated menu keys. The menu keys are arranged as they appear in the analyzer menus.

Key Descriptions and Locations

This chapter provides information on Phase Noise mode functions only. Some keys are described that are either not available in Spectrum Analysis (SA) mode, or that provide functions which differ from those provided by the same keys in SA mode. Other keys are described which provide fewer functions than the same key in SA mode, but the functions that are provided are identical in both modes. For those keys not described here, refer to the *ESA Spectrum Analyzers User's Guide*.

AMPLITUDE Y Scale -	Page 197
BW/Avg	Page 199
Det/Demod	Page 201
Display	Page 203
FREQUENCY Channel	Page 207
Input/Output	Page 210
Marker	Page 213
Peak Search	Page 215
Meas Setup	Page 217
MEASURE	Page 223
MODE	Page 224
Mode Setup	Page 225
Mode Setup — DUT Setup	Page 226
Mode Setup - Uncertainty Calculator	Page 228
Preset	Page 231
Source	Page 232
SPAN X Scale	Page 233
Sweep Menu	Page 234
View/Trace	Page 235

AMPLITUDE Y Scale

Accesses the amplitude menu keys and the Reference Level functions. Amplitude menu keys are used for setting functions that affect the way data on the vertical axis is displayed or corrected.

Scale/Div	Sets the units per vertical graticule division in the measurement window on the display. If more than one measurement window is displayed (for example, when making Noise Figure measurements), the active window is indicated by a green border. The active window can be changed by pressing the Next Window key.
Ref Value	Allows you to specify the amplitude level represented by the Ref Position (see below) on the graticule display. The units of measurement are either dB or Kelvin, depending on the measurement being displayed in the active window.
Ref Position	The reference position on each trace is indicated by a small chevron (the ‘>’ and ‘<’ signs) at either side of the graticule. The value of this reference position on the graticule is specified with the Ref Value key (see above). The Ref Position key allows you to vary the position of the reference trace between top, center, and bottom of the graticule. This key is only available in Noise Figure measurements. <ul style="list-style-type: none"> Top Sets the reference position to the top line of the graticule. Its position is indicated by a small chevron on either side of the graticule. Ctr Sets the reference position to the center of the graticule. Its position is indicated by a small chevron on either side of the graticule. Bot Sets the reference position to the bottom line of the graticule. Its position is indicated by a small chevron on either side of the graticule.
Auto Scale	Automatically sets both the Scale/Div and the Ref Value to values that are suitable for the current trace data. This key and function is only available when Noise Figure is selected on the Measure menu.
Ref Level	Allows you to specify the absolute amplitude level represented by top line on the graticule display. The units of measurement are dB.
Attenuation	Allows you to adjust the input attenuation in 5 dB increments on the ESA-E Series of analyzers. The analyzer input attenuator reduces the power level of the input signal delivered to the input mixer. If set manually, the attenuator is recoupled when Attenuation (Auto) is selected. This key and function is only available when Spectrum Monitor is selected on the Measure menu.

Optimize Ref Level Optimizes the Reference Level and Attenuation settings for the current signal. The Reference Level will be set to a value that keeps the signal as close as possible to the top of the display. Attenuation will be set to a level that maintains a maximum mixer level of -20 dBm.

BW/Avg

Activates the resolution bandwidth function, and displays the menu keys that control both the bandwidth and averaging functions.

Res BW

Allows you to specify the Resolution Bandwidth manually, or to set it to Auto.

Sweep time is coupled to RBW. As the RBW changes, the sweep time (if set to **Auto**) is changed to maintain amplitude calibration.

Manual Allows you to select the 3 dB filter bandwidth (RBW) of the analyzer's resolution bandwidth filter.

The stepping sequence (and therefore the available bandwidth settings) follow a 1:3:10 pattern, that is, from 10 to 30, from 30 to 100, from 100 to 300, and so on.

If an unavailable bandwidth is entered with the numeric keypad, the closest available bandwidth is selected.

Auto The resolution bandwidth is automatically set for the best results.

The resolution bandwidth, again, depends on the measurement frequency and is set according to the following table:

Table 6-1 Resolution Bandwidth Values on the ESA Series of Analyzers

Measurement Frequency	Resolution Bandwidth
Less than 130 kHz	1 kHz
130 kHz or greater, and less than 380 kHz	3 kHz
380 kHz or greater, and less than 980 kHz	10 kHz
980kHz or greater, and less than 2.8 MHz	30 kHz
2.8 MHz or greater, and less than 7.4 MHz	100 kHz
7.4 MHz or greater, and less than 21 MHz	300 kHz
21 MHz or greater	1 MHz

NOTE Recalibration is required if the RBW changes.

Video BW

Enables you to change the analyzer post-detection filter.

The available range is from 30 Hz to 3 MHz in a 1,3,10 sequence.

BW/Avg

Video BW (Auto) selects automatic coupling of the Video BW filter to the resolution bandwidth filter using the VBW/RBW ratio set by the **VBW/RBW** key.

VBW/RBW

Sets the ratio between the video and resolution bandwidths.

Det/Demod

Displays a menu where you can set the controls and parameters associated with the detector modes. When making Noise Figure measurements, only **Average** detection is available.

Detector

Selects a specific detector, or uses the system to pick the appropriate detector (through **Auto**) for a particular measurement.

When discussing detectors, it is important to understand the concept of a trace “bucket.” For every trace point displayed, there is a finite time during which the data for that point is collected. The analyzer has the ability to look at all of the data collected during that time and present a single point of trace data based on the detector mode. We call the interval during which the data for that trace point is being collected, the “bucket.” Thus, a trace is more than a series of single points. It is actually a series of trace “buckets.” The data may be sampled many times within each bucket.

When the **Detector** choice is **Auto**, the detector selected depends on marker functions, trace functions, and the trace averaging function.

When you manually select a detector (instead of selecting **Auto**), that detector is used regardless of other analyzer settings.

The detector in use is indicated on the left side of the display. If the detector has been manually selected, a # appears next to it.

- Auto** When set to **Auto**, the type of detector selected depends on marker functions, trace functions, and the trace averaging function. Peak detection is the default.

If a condition arises where a different type of detection scheme would be better utilized, the system uses the alternate scheme. For example, when in Auto mode, the Marker Noise function uses Average detection because the system determines that the data is more accurate for noise-type signals.
- Sample** The **Sample** detector displays the instantaneous level of the signal at the center of the bucket represented by each display point.
- Average** The **Average** detector is the only type of detector available when making Noise Figure measurements. The **Average** detector displays the average of the signal within the bucket. The averaging method depends upon **Avg/VBW Type** selection of either **Log-Pwr Avg** (Video) or **Pwr Avg** (RMS).
- Peak** The **Peak** detector displays the maximum of the signal

within the bucket.

Negative Peak The **Negative Peak** detector displays the minimum of the signal within the bucket.

NOTE Because they may not find a spectral component's true peak, neither average nor sample detectors measure amplitudes of CW signals as accurately as peak or normal, but they do measure noise without the biases of peak detection.

Display

This front panel key accesses the menu key that allows you to see and setup different measurement displays.

- Full Screen** Extends the measurement window over the entire analyzer display, removing the key menu as it does so. To restore the key menu, press any key except **Print**, **Save**, or any of the data entry keys.
- Display Line** Allows you to adjust the vertical position of the horizontal display line, or to remove it altogether.
- On** Switches the display of a horizontal green line **On**. This line can be used as a visual reference line, and can be used for trace arithmetic.
- Off** Switches the display of the horizontal reference line **Off**.
- Preferences** This displays a further menu giving you control over some aspects of the display's appearance.
- Graticule** Allows you to display or hide the graticule lines on the display.
- Annotation** Allows you to display or hide some of the annotation pertaining to the current display.
- Limits** The limit lines mark boundary limits of a trace. Limit lines feature four independent lines numbered from 1 to 4. Limit lines 1 and 2 are associated with the upper graph, and limit lines 3 and 4 are associated with the lower graph. The limit lines can be set to inform you when the trace of interest crosses one of the limit lines. The limit lines can be set as an upper or lower limit. They can also be displayed on the associated graph.
- The **Limits** key selects one of the four possible limit lines. **Limit Line 1**↑ and **Limit Line 2**↑ are associated with the upper graph, and **Limit Line 3**↓ and **Limit Line 4**↓ are associated with the lower graph. The selected limit line is underlined and the **Edit...** key in the limit line menu then applies to that limit line.
- Edit...** Displays a form which allows you to enter a table of limit line data for the limit line that was underlined in the previous menu. It also displays a series of key menus, each of which allows you change the setting of the field highlighted on the form.
- State** Allows you to switch the limit line **On** or **Off**.
- On** Switches the limit line **On**.
- Off** Switches the limit line **Off**.

Type	Allows you to set the selected limit line to either an Upper or a Lower limit. The limit line is tested against the trace if Test is set to On .
	Upper The limit line you have specified is an upper limit. Measurement results that are lower than the limit line are deemed to have passed.
	Lower The limit line you have specified is a lower limit. Measurement results that are higher than the limit line are deemed to have passed.
Display	Allows you to switch the limit line display On or Off . Limit line checking still takes place when the trace is switched Off . Switching the limit line display Off is simply a convenient way of tidying up the display.
	On Switches the limit line display On .
	Off Switches the limit line display Off .
Test	Allows you to switch the limit line test On or Off . Limit line testing only takes place when Test is switched On , and the limit state is on.
	On Switches the limit line test On .
	Off Switches the limit line test Off .

The Limit Lines

Point Table	The table allows you to define the limit line by entering up to 101 different pairs of frequency and limit values.
Point	Specifies the point number. The point number is the same as the row number within the limit line table.
Frequency	Specifies the frequency for which you want to set a limit.
Limit Value	Sets the limit at the specified frequency. Limit values have no explicitly defined unit of measure. The unit of measure is derived from the measurement being made, so changing the measurement will also change the unit of measure.

When entering the limit value, you must use the numeric keys on the front panel. Once you have entered the first numeric value, the key menu changes to allow you to set the magnitude of the

limit value.

x1e9 (G)

The limit value is set as the number you entered multiplied by 10^9 (Giga-units)

x1e6 (M)

The limit value is set as the number you entered multiplied by 10^6 (Mega-units)

x1e3 (k)

The limit value is set as the number you entered multiplied by 10^3 (kilo-units)

x1

The limit value is set exactly as the number you entered

x1e-3 (m)

The limit value is set as the number you entered multiplied by 10^{-3} (milli-units)

x1e-6 (μ)

The limit value is set as the number you entered multiplied by 10^{-6} (micro-units)

x1e-9 (n)

The limit value is set as the number you entered multiplied by 10^{-9} (nano-units)

**Connected To
Previous Pt**

Determines whether or not the current limit point is connected to the previous point. When set to **Yes**, the limit line passes in a straight line from the previous point to the current point.

When set to **No**, the limit line is set to an infinitely large value (either negative or positive, depending on the type of limit line) between this point and the previous point. The trace will

therefore never fail a limit test between these points.

Delete Row Deletes the current row from the table of limit line data.

Delete All Deletes the entire limit line table. When you press this key, you will be asked to press it again to confirm that you wish to delete the entire table. Either press **Delete All** again to confirm the deletion, or press **ESC** to abort the action.

New Entry Selects the last row in the table ready for input.

NOTE You are allowed to enter a maximum of two sets of limit line data for any one frequency value.

Disable All Limits This switches off all of the limit lines, including any result testing and annotation.

NOTE When a limit line is switched off the limit line data is unchanged and can be reset if the limit line is switched on again.

FREQUENCY Channel

Accesses the menu of frequency functions.

Center Freq This allows you to set the frequency at which the measurement frequency range is centered. When you change the Center Frequency, the Start and Stop Frequencies are adjusted without modifying the Span setting. When **Center Freq** is selected its value is displayed above the graticule.

Start Freq This allows you to set the frequency at which the measurement sweep starts. In the graphical format, the trace starts at the left side of the graticule. When **Start Freq** is selected its value is displayed above the graticule.

CAUTION Do not switch to DC Coupling if the input signal contains a DC component. You risk permanently damaging the analyzer's front end mixer if you do this.

When measuring at frequencies below those shown in [Table 6-2 on page 207](#), Agilent recommends that you switch to DC coupling for greater measurement accuracy. Do not switch to DC coupling if the analyzer's input signal has a DC component. You risk permanently damaging the analyzer's front end mixer if you feed a DC input signal to the analyzer when it is switched to DC coupled.

Table 6-2 When to use DC Coupling on the ESA Series of Analyzers

Model Number	Switch to DC Coupling Below this Frequency
E4401B	Always AC coupled
E4402B without Option UKB	Always AC Coupled
E4402B with Option UKB	100 kHz
E4404B with or without Option UKB	100 kHz
E4405B with or without Option UKB	100 kHz
E4407B Without Option UKB	Always DC Coupled
E4407B with Option UKB	10 MHz

CAUTION Do not switch to DC Coupling if the input signal contains a DC component. You risk permanently damaging the analyzer's front end mixer if you do this.

Stop Freq This allows you to set the frequency at which the measurement sweep stops. In the graphical format, the trace stops at the right side of the graticule. When you change the Stop frequency, the Span and Center Frequencies will be adjusted to keep the measurement frequency range centered. When **Stop Freq** is selected its value is displayed above the graticule.

Freq Offset The default setting for frequency offset is **Man**. When set to **Man**, the Frequency Offset can be set by using the numeric keypad, the knob, or the step keys.

You can also set the frequency offset to **Auto**. When set to **Auto**, the frequency offset settings are calculated automatically using the settings under DUT Setup.

The frequency offset is used to account for frequency conversions external to the analyzer. This value is added to the display readout of the marker frequency, center frequency, start frequency, stop frequency, and all other absolute frequency settings in the analyzer. When a frequency offset is entered, the value appears below the center of the graticule. To eliminate an offset, perform a Factory Preset or manually set the frequency offset to 0 Hz.

NOTE This command does not affect any bandwidths or the settings of relative frequency parameters such as delta markers or span. It does not affect the current hardware settings of the analyzer, but only the displayed frequency values. Offsets are not added to the frequency count readouts. Entering an offset does not affect the trace display.

NOTE Frequency Context (**Mode Setup, DUT Setup...**) must be set to RF for the Auto setting of Freq Offset to have any effect. When the Frequency Context is set to IF, and Freq Offset is set to Auto, the frequency offset will be set to 0 Hz. All frequencies are displayed as they are at the analyzer input, that is, after the DUT.

Freq Mode This selects between swept, list and fixed frequency modes. The selected frequency mode is displayed in the menu key.

The frequency modes available are:

- Sweep** The measurements are made at frequencies generated from the selected frequency range and the number of measurement points.
- Fixed** The measurements are made at a fixed frequency.
- List** The measurements are made at the frequencies specified in the frequency table.

Fixed Freq This allows you to set the frequency point used in fixed frequency measurements. When **Fixed Freq** is selected its value is displayed in the

left and right lower annotation as start and stop values respectively.

Points This allows you to set the number of discrete equidistant frequency points at which measurements are made during **Sweep** frequency mode. The maximum number of points allowed is 401. The default value is 11. The number of points is shown at the bottom of the display.

NOTE The maximum number of 401 points is conditional, as this number is limited by the frequency span. Where the minimum resolution between any two points is set at 10 kHz, the frequency's measurement range must be greater than 4 MHz to achieve 401 points.

Freq List... This allows you access to a form to enter or edit a frequency list.

The frequency list allows you to enter a list of frequencies at which measurements are to be made. Frequency lists are limited to 401 entry points. The number of points is shown at the bottom of the display.

The frequencies are automatically sorted in ascending order, and duplicate frequencies are allowed. When a frequency is duplicated in the table, that frequency will be measured once for each entry.

Index This allows you to enter the index number (that is, the row number) of the table entry that you wish to edit. This gives you quick access to that row.

Frequency This allows you to specify a frequency at which a measurement will be made. If you enter the same frequency more than once in the table, that frequency will be measured once for each entry in the table.

Fill This clears the existing frequency table, and then automatically generates a new table of frequencies. The number of entries in the new table is determined by the **Points** setting (see [page 209](#)). The frequencies will be linearly distributed from the **Start Freq** to the **Stop Freq** (see [page 207](#)).

New Entry Selects the last row in the table ready for input.

Delete Row This deletes the currently highlighted row entry from the table.

Delete All This deletes all entries from the table. When you press this key, you will be asked to press it a second time to confirm that you wish to delete all the entries in the table. To back out of this action and keep all the table's entries, press the **ESC** key.

Input/Output

Displays a menu that allows you to control the input and output signals to and from the analyzer.

Noise Figure Corrections

This key accesses menus that allow you to set **Noise Figure Correction On** or **Off**, and to enter the minimum and the maximum attenuation values used in calibration.

Noise Figure Corrections

This allows you to select between corrected and uncorrected results. This key is grayed out unless a valid calibration (**Meas Setup, Calibration...**) has been performed.

On The display shows corrected data.

Off The display shows uncorrected data.

NOTE

If you change the frequency range to greater than the current calibration, the message "User Cal invalidated; Freq outside cal range" is displayed. If you want corrected measurements over a greater range, you need to calibrate the analyzer again before making this measurement.

If you change the frequency range to less than the current calibration, the message "User Cal will be interpolated" is displayed. This demonstrates that the analyzer is using interpolated results and interpolated errors may be introduced.

Input Cal

The menu key gives you access to menu keys allowing you to set the maximum and minimum attenuator values.

Min Atten This menu key allows you to change the RF attenuator's minimum input attenuation during calibration. The range is from **0 dB** to **40 dB**. It can be set in 5 dB steps on the ESA-E series. The default value is **0 dB**.

Max Atten This menu key allows you to change the RF attenuator's maximum input attenuation during calibration. It can be set in in 5 dB steps on the ESA-E series. The default value is **10 dB**.

Loss Comp

This key accesses features which allow the analyzer to compensate for losses. For example, the losses could be due to additional cabling either before or after the DUT's measurement or both. You can compensate for

this loss either by using the same fixed value over the whole frequency span, or by using values that vary across the frequency span and which have been specified in a table.

Setup... Brings up the Loss Compensation form, allowing you to specify the parameters associated with loss compensation.

Loss Compensation Before DUT Allows you to specify what type of Loss Compensation is used before the Device Under Test.

- **Off** - No loss compensation is made before the DUT.
- **Fixed** - Loss Compensation is at a fixed value over the entire frequency span.
- **Table** - Loss Compensation varies across the frequency span, using values specified in a table.

Before DUT Fixed Value This sets the amount of compensation, before the device under test, as a fixed value. This is only valid if the **Before DUT(Fixed)** is enabled. You can enter the value as dB or linear. However, the linear value is converted to dB. The lower limit is -100.000 dB and the upper limit is 100.000 dB. The default value is 0.000 dB.

Before DUT Temperature This sets the temperature of loss compensation, before the device under test, as a fixed value. This is only valid if **Before DUT** is enabled. You can enter the value as **K** (Kelvin), **C** (degrees Celsius), or **F** (degrees Fahrenheit). However, the **C** and **F** values are converted to **K**. The lower limit is 0.00K and the upper limit is 29,650,000.00 K. The default value is 0.00K.

Loss Compensation After DUT Allows you to specify what type of Loss Compensation is used after the Device Under Test.

- **Off** - No loss compensation is made after the DUT.
- **Fixed** - Loss Compensation is at a

fixed value over the entire frequency span.

- **Table** - Loss Compensation varies across the frequency span, using values specified in a table.

After DUT Fixed Value This sets the amount of compensation, after the device under test, as a fixed value. This is only valid if the **After DUT(Fixed)** is enabled. You can enter the value as dB or linear. However, the linear value is converted to dB. The lower limit is -100.000 dB and the upper limit is 100.000 dB. The default value is 0.000 dB.

After DUT Temperature This sets the temperature of loss compensation, after the device under test, as a fixed value. This is only valid if **After DUT** is enabled. You can enter the value as **K**, **C**, or **F**. However, the **C** and **F** values are converted to **K**. The lower limit is 0.00K and the upper limit is 29,650,000.00 K. The default value is 0.00K.

Before DUT Table... Brings up the Loss Compensation Before DUT editor.

After DUT Table... Brings up the Loss Compensation After DUT editor.

Attenuation Allows you to adjust the input attenuation. The range of settings is limited by the Min Atten and Max Atten settings (see [page 210](#)). Within this range, it can be set in 5 dB steps. Peak detection is the default. The analyzer input attenuator reduces the power level of the input signal delivered to the input mixer.

Presel Adjust *E4404B, E4405B, E4407B only.* Allows you to manually adjust the frequency position of the center of the preselector. This removes the possibility of your measurement frequency falling outside the passband for the preselector filter as this would reduce the accuracy of your results.

Input/Output Displays the basic spectrum analyzer's Input/Output menu. Refer to the *ESA User's/Programmer's Reference* for more information.

CAUTION Do not switch to DC Coupling if the input signal contains a DC component. You risk permanently damaging the analyzer's front end mixer if you do this.

Marker

Displays a menu that allows you to set each of the four markers to mark and measure at particular points on the traces.

Select Marker

Allows you to select one of the four possible markers. Having selected one of the markers, use the other keys on this menu to specify the type of marker or measurement.

Normal

Places a marker at the beginning of each graph's trace. If a marker has been displayed previously and is reactivated, the marker is enabled at the marker's previously selected position. The marker number is indicated above the marker.

Use the knob to control the position of the marker. Its frequency value is displayed in the active function area and frequency and measurement parameter values are reported above the graph.

Pressing **Normal** when the **Delta** or **Band Pair** function is enabled, switches off the reference marker.

Delta

Activates a second marker at the position of the first marker. It is identified as a reference marker and its position is fixed. (If no marker is present, the marker appears at the center of the graph, or if the marker has been previously active it appears in the last marker position) The marker number is indicated above the delta marker, and the same number is indicated with an **R** (for example, **1R**) above the reference marker. Use the knob to position the delta marker.

The delta marker's frequency value is displayed in the active function area. Also frequency and measurement parameter values are reported above the graph to indicate the difference between the two markers. The reference marker's position remains fixed until delta is disabled.

Delta Pair (Tracking Ref)

Allows adjustment of the two markers independently. It is similar to the delta marker mode, except you can choose to move the normal marker or the reference marker. Pressing the **Delta Pair** key allows you to toggle between the Reference Marker and the Delta Marker. The reference marker number is indicated with a number and an **R** (for example, **1R**) and the normal marker is indicated with a marker number.

The band pair marker's frequency value is displayed in the active function area. Also the frequency and measurement parameter values are reported below the graph to indicate the difference between the two markers.

Off

Switches the specified marker off.

Marker All Off Switches all markers off. All markers are removed from the graticule display.

Peak Search

Displays a menu that allows you to set each of the four markers to mark, or display, a particular measurement.

Select Marker Allows you to select one of the four possible markers. Having selected one of the markers, use the other keys on this menu to specify the type of peak search to be performed by this marker.

Search Type Allows you to select the type of peak search to be performed. The peak search is performed on the active measurement or trace. When you have two traces displayed in two separate graphs on the display, the active trace or measurement is indicated by a green border around the graph, and by underlining the measurement name to the left of the graticule. To change the active trace or measurement, press the Next Window key on the front panel.

When you are displaying combined traces in one graph, the green border disappears, and the active trace or measurement is indicated solely by the underlining of the measurement name.

Minimum The marker will be placed at the minimum point on the trace. This key is grayed out when the marker has been defined as a **Delta Pair (Tracking Ref)** marker (see [page 213](#)).

Maximum The marker will be placed at the maximum point on the trace. This key is grayed out when the marker has been defined as a **Delta Pair (Tracking Ref)** marker (see [page 213](#)).

Pk-Pk When **Peak to Peak** is enabled, the active two markers are placed on the highest and lowest trace points. The reference marker is placed on the highest peak while the normal marker is placed on the lowest trough. Its frequency and measurement parameter values are reported below the graph to indicate the difference between the two markers.

This key is only available when the marker has been defined as a **Delta Pair (Tracking Ref)** marker (see [page 213](#)).

Continuous Sets the continuous peak search On or Off. When Continuous is enabled, the active marker continuously finds the maximum, minimum, or peak-to-peak on the trace as successive sweep results are reported. This is dependent on which search type is selected. When Continuous is disabled, the marker search is controlled by the Find menu key.

Find Pressing the Find menu key manually places an active search marker.

Peak Search

This functions when Continuous has been set to Off, and a Marker has been enabled. The annotation displays the frequency and measurement parameter differences. Also in the Find mode the marker's frequency value is displayed in the active function area.

Meas Setup

Displays a menu that allows you to enter custom setup parameters for a measurement. The setup menu displayed depends on whether the Monitor Spectrum or the Noise Figure measurement was selected in the **MEASURE** menu. Some keys are the same as in the basic Spectrum Analyzer mode. Refer to the *ESA User's/Programmer's Reference* for more information on these keys.

Avg Number Allows you to specify the number of measurements that will be averaged. After the specified number of average counts, the **Avg Mode** setting determines the averaging action. You can also set the averaging function to **On** or **Off**.

Avg Mode **On** Enables the measurement averaging.
Off Disables the measurement averaging.

Allows you to select the type of termination control used for the averaging function. This determines the averaging action after the specified number of measurements (average count) is reached.

Exp After the average count is reached, each successive data acquisition is exponentially weighted and combined with the existing average.
Repeat After the average count is reached, the averaging is reset and a new average is started.

Int Preamp Allows you to turn the internal preamplifier **On** or **Off** manually.

On Switches the internal preamp On.
Off Switches the internal preamp Off.

Restore Meas Defaults Sets up the analyzer parameters for the measurement using the factory default analyzer settings. (This only affects measurement parameters for this measurement and does not affect any mode parameters.) If you have made any manual changes to the measurement parameters, restoring the measurement defaults will ensure valid measurements.

Calibrate This performs the internal calibration routine. The calibration is similar to a measurement except that the device under test is not in the measurement path. It is used to correct any noise added by the second stage test system.

You must press the **Calibrate** key twice before calibration starts. After the first press you are presented with a popup dialogue box that prompts you to press the calibrate key a second time to start the calibration, or to press **ESC** to abandon the calibration.

The values generated during a calibration are used to correct subsequent measurements as long as the calibration remains valid or until the next calibration.

ENR

This accesses a menu which allows you to select a noise source preference, enter the ENR tables, specify a T_{cold} temperature, specify a spot T_{hot} temperature, or select a spot frequency ENR value.

ENR Mode This allows you to select the ENR (Excess Noise Ratio) mode for the measurement.

Table Sets the ENR mode to **Table**. All ENR data is taken from the table of data.

Spot Sets the ENR mode to **Spot**. All ENR table data is ignored, and a single value specified in **SPOT ENR** or **SPOT Thot** is used instead.

Common Table This allows you to turn the Common ENR Data Table **On** or **Off**.

On When Common Table is **On**, the same noise source ENR data is used during both the measurement and the calibration.

Off When Common Table is **Off**, separate noise source ENR data is used for the measurement and the calibration.

Meas and Cal Table This displays the form allowing you to enter the ENR table data that is used for both measurement and calibration.

Serial # This allows you to enter the serial number of the noise source associated with the ENR table. To enter a value, you use the Alpha Editor which is presented and the numerical keypad. Its value is displayed in the highlighted area and in the active function area. To complete the entry press the **Return** key or the **ESC** key, or use the **Tab** key to move to the next field.

Model ID This allows you to enter the model number of the noise source associated with the ENR table. To enter a value, you use the Alpha Editor which is presented and the numerical keypad. Its value is displayed in the highlighted area and in the active function area. To

complete the entry press the **Return** key or the **ESC** key, or use the **Tab** key to move to the next field.

Index	This allows you to enter the index number (that is, the row number) of the table entry that you wish to edit. This gives you quick access to that row.
Frequency	This allows you to specify a frequency at which an ENR value can be entered.
ENR Value	This allows you to enter an ENR value for the specified frequency. The valid units of measurement are dB, K, C, or F
Delete Row	This deletes the currently highlighted row entry from the table.
Delete All	This deletes all entries from the table. When you press this key, you will be asked to press it a second time to confirm that you wish to delete all the entries in the table. To back out of this action and keep all the table's entries, press the ESC key.
New Entry	Selects the last row in the table ready for input.
Meas Table...	This displays the form allowing you to enter the ENR table data that is used for measurement. This measurement ENR table is used for measurements when Common Table (see page 218) is switched Off . When Common Table is switched On , this same table of ENR data is used both for measurements and for calibration.
Serial #	This allows you to enter the serial number of the noise source associated with the ENR table. To enter a value, you use the Alpha Editor which is presented and the numerical keypad. Its value is displayed in the highlighted area and in the active function area. To complete the entry press the Return key or the ESC key, or use the Tab key to move to the next field.
Model ID	This allows you to enter the model number of the noise source associated with the ENR table. To enter a value,

you use the Alpha Editor which is presented and the numerical keypad. Its value is displayed in the highlighted area and in the active function area. To complete the entry press the **Return** key or the **ESC** key, or use the **Tab** key to move to the next field.

Index	This allows you to enter the index number (that is, the row number) of the table entry that you wish to edit. This gives you quick access to that row.
Frequency	This allows you to specify a frequency at which an ENR value can be entered.
ENR Value	This allows you to enter an ENR value for the specified frequency. The valid units of measurement are dB , K , C , or F
Delete Row	This deletes the currently highlighted row entry from the table.
Delete All	This deletes all entries from the table. When you press this key, you will be asked to press it a second time to confirm that you wish to delete all the entries in the table. To back out of this action and keep all the table's entries, press the ESC key.
Cal Table...	This displays the form allowing you to enter the ENR table data that is used for calibration. This calibration ENR table is used for calibration when Common Table (see page 218) is switched Off . When Common Table is switched On , the table of ENR data that is used for measurements will also be used for calibration, and the data in this calibration table will therefore not be used.
Serial #	This allows you to enter the serial number of the noise source associated with the ENR table. To enter a value, you use the Alpha Editor which is presented and the numerical keypad. Its value is displayed in the highlighted area and in the active function area. To complete the entry press the Return key or the ESC key, or use the Tab key to move to the next field.
Model ID	This allows you to enter the model number of the noise source associated with the ENR table. To enter a value,

you use the Alpha Editor which is presented and the numerical keypad. Its value is displayed in the highlighted area and in the active function area. To complete the entry press the **Return** key or the **ESC** key, or use the **Tab** key to move to the next field.

Index	This allows you to enter the index number (that is, the row number) of the table entry that you wish to edit. This gives you quick access to that row.
Frequency	This allows you to specify a frequency at which an ENR value can be entered.
ENR Value	This allows you to enter an ENR value for the specified frequency. The valid units of measurement are dB , K , C , or F .
Delete Row	This deletes the currently highlighted row entry from the table.
Delete All	This deletes all entries from the table. When you press this key, you will be asked to press it a second time to confirm that you wish to delete all the entries in the table. To back out of this action and keep all the table's entries, press the ESC key.
New Entry	Selects the last row in the table ready for input.
SNS Setup	This key is used to setup how any Smart Noise Source ('SNS') is used in your noise figure measurements.
Preference	Use this key to specify which type of noise source you wish to use in your measurements. Select SNS to use a Smart Noise Source, or Norm to use a normal noise source. If you have Preference set to SNS but do not have an SNS attached, the analyzer will default to controlling a normal noise source until an SNS is attached.
Auto Load ENR	This allows you to switch the SNS's auto load capability On or Off . When set to On , the ENR data held in the SNS will be loaded automatically every time

an SNS is connected to the analyzer. Any ENR data currently held in the analyzer will be overwritten. When set to **Off**, the SNS's ENR data will not be loaded, and any pre-existing ENR data will be retained.

Spot	This allows you to select a specific ENR value or T_{hot} value. The selected value is applied across the entire frequency range during calibration and measurement.
Spot State	This switches between the ENR and the Thot modes. The default is ENR .
Spot ENR	This allows you to enter a spot ENR value which is applied across the entire frequency range during calibration and measurement. The value is applied when Spot State of ENR and ENR Mode of Spot are enabled. The default value is 15.200 dB. The ENR value is entered using the numeric key pad and terminated by selecting unit menu keys.

NOTE The **dB** limits have a lower limit of -7.0 dB and an upper limit of 50.0 dB.

The **K**, **C**, and **F** limits are converted to the dB limits.

Spot Thot	This allows you to enter a spot T_{hot} value which is applied across the entire frequency range during calibration and measurement. The value is applied when Spot State of Thot and ENR Mode of Spot are enabled. The default value is 9892.80 K.
------------------	---

The T_{hot} value is entered using the numeric key pad and terminated by selecting unit menu keys.

NOTE The **K** limits have a lower limit of $0.00K$ and an upper limit of $29,650,000.0$ K.

The **C** and **F** limits are converted to the K limits.

T cold	This key allows you to select the default T_{cold} value of 296.50 K, or to enter the own T_{cold} value.
---------------	---

MEASURE

Accesses menu keys that allow you to make Monitor Spectrum, and Noise Figure measurements.

Monitor Spectrum

Displays the frequency spectrum.

Noise Figure

Gives you access to the range of Noise Figure measurements and parameters.

MODE

Accesses menu keys allowing you to select the measurement mode of the analyzer. Additional measurement personality software must be installed and activated in the analyzer for the other mode keys to be labeled and functional.

Spectrum Analysis

Accesses the spectrum analyzer menu keys and associated functions.

Noise Figure

Accesses the Noise Figure measurement personality menu keys and associated functions. This allows you to setup and make valid Noise Figure measurements.

NOTE

This menu will have additional entries if other personalities have been installed, for example GSM Option BAH or cdmaOne Option BAC.

Mode Setup

Accesses a menu allowing you to view information about the Noise Figure application and to set the noise figure measurement parameters back to their factory default settings.

DUT Setup...	Displays the DUT Setup Form. See Mode Setup — DUT Setup (page 226) for further details.
Uncertainty Calculator...	Displays the Uncertainty Calculator. You can choose between displaying and specifying the individual parameters, or of displaying the calculations used to arrive at the noise figure uncertainty. View Calculations Pressing this key displays the calculations used to derive the uncertainty figure. See Mode Setup — Uncertainty Calculator (page 228) for further details. View Calculator Pressing this key displays form allowing you to enter and view the individual parameters that contribute to the noise figure uncertainty. See Mode Setup — Uncertainty Calculator (page 228) for further details.
Properties...	Displays the Noise Figure application version number.
Restore Mode Setup Defaults	Sets up the spectrum analyzer's parameters for the mode using the factory default mode settings.

Mode Setup — DUT Setup

The DUT Setup form allows you to prepare the analyzer to make noise figure measurements on specific devices. The keys you will see depend on the parameter that you are setting.

DUT	This allows you to specify the type of DUT that you are testing. Amplifier Set the DUT to Amplifier when you are testing a device that performs no frequency conversion of its own. The device can be used with or without an external system downconverter. UpConv Set the DUT to UpConv when you are testing a device that performs internal frequency upconversion. DownConv Set the DUT to DownConv when you are testing a device that performs internal frequency downconversion.
System Downconverter	This selects whether or not the System Downconverter is On or Off . This is only accessible if the Device Under Test is set to Amplifier . On Set the System Downconverter On. Off Set the System Downconverter Off.
Ext LO Freq	This allows you to specify the LO frequency of the device specified under DUT.
Sideband	This allows you to set the measurement side-band selection, where the selected measurement mode allows, to either lower side-band (LSB), upper side-band (USB), double side-band (DSB). LSB Lower Sideband (signal frequency < LO Frequency). USB Upper Sideband (signal frequency > LO Frequency). DSB Double Sideband. DSB is only available for DUTs of type DownConv
Freq Context	This allows you to determine how frequencies are interpreted when using a frequency converting device. IF Analyzer Input The frequencies are displayed as they are when entering the DUT, that is before any frequency conversion has taken place. RF DUT Input The frequencies are displayed as they are when leaving the DUT or the system downconverter, that is after any frequency conversion has taken place. These are the frequencies that the analyzer is actually measuring.

Diagram

A diagram is displayed at the bottom of the screen to help you set up the measurement or the calibration. This key allows you to determine whether the diagram represents the measurement setup, or the calibration setup.

Calibration The diagram represents a calibration setup when using the DUT that you have specified.

Measurement The diagram represents a measurement setup when using the DUT that you have specified.

Mode Setup - Uncertainty Calculator

Displays the Uncertainty Calculator. This makes a frequency-independent calculation using one ENR uncertainty value. While it provides a good estimation of the measurement uncertainty, you may want more accuracy. You may want to use more accurate values for ENR, gain and VSWR, or calculate values at a specific frequency of interest or at multiple frequencies. Refer to Application Note 57-2, Agilent part number 5952-3706E, for more information about calculating noise figure uncertainties. This document can be found at: <http://www.agilent.com/find/nfu>

View Calculations Pressing this key displays the calculations used to derive the uncertainty value.

View Calculator Pressing this key displays a form allowing you to enter and view the individual parameters that contribute to the noise figure uncertainty.

Noise Source Model Allows you to select a predefined noise source model using the displayed default values, or to define your own noise source.

User Defined Select **User Defined** to define your own noise source, and to specify its parameters manually.

Agilent 346A Select **Agilent 346A** if you are using an Agilent Technologies 346A noise source. The ENR Uncertainty and Match for this noise source will be set automatically.

Agilent 346B Select **Agilent 346B** if you are using an Agilent Technologies 346B noise source. The ENR Uncertainty and Match for this noise source will be set automatically.

Agilent 346C Select **Agilent 346C** if you are using an Agilent Technologies 346C noise source. The ENR Uncertainty and Match for this noise source will be set automatically.

Agilent N4000A Select **Agilent N4000A** if you are using an Agilent Technologies N4000A Smart Noise Source. The ENR Uncertainty and Match for this noise source will be set automatically.

Agilent N4001A Select **Agilent N4001A** if you are using an Agilent Technologies N4001A Smart Noise Source. The ENR Uncertainty and Match for this noise source will be set automatically.

<http://www.agilent.com/find/nfu>

Agilent N4002A Select **Agilent N4002A** if you are using an Agilent Technologies N4002A Smart Noise Source. The ENR Uncertainty and Match for this noise source will be set automatically.

<http://www.agilent.com/find/nfu>

ENR Uncertainty Allows you to set the set and view the Excess Noise Ratio (ENR) Uncertainty of the noise source.

NS Match Allows you to set the set and view the 50 ohm Match of the User Defined noise source. The Match can be entered as Return Loss, VSWR, or as a Reflection Co-efficient. You do not need to specify the unit of measurement, if any. The value you enter is used to determine the what the entry is, as described below:

< 0 Return Loss, unit of measurement is dB

≥ 0 and < 1 Reflection coefficient, no unit of measurement

≥ 1 VSWR, no unit of measurement

Noise Figure Allows you to enter the noise figure of the DUT and the analyzer.

DUT Enter the noise figure of the DUT.

Instrument Enter the noise figure of the analyzer.

Noise Figure Uncertainty Allows you to enter the noise figure uncertainty of the analyzer.

Gain Allows you to enter the gain of the DUT.

Gain Uncertainty Allows you to enter the gain uncertainty of the analyzer.

Input Match Allows you to enter the 50 ohm input match of the DUT and of the analyzer.

DUT Enter the 50 ohm input match of the DUT.

Instrument Enter the 50 ohm input match of the analyzer.

Output Match Allows you to enter the 50 ohm output match of the DUT.

RSS Noise Figure Meas Uncertainty This displays the RSS (Root Sum Squared) Noise Figure Measurement Uncertainty value as calculated from the parameters that you entered.

Preset

Provides a convenient starting point for making most measurements.

Depends on the preset type setting (user, mode, or factory) in the System keys. If the preset type is set to **Factory**, pressing **Preset** results in an immediate analyzer preset to the factory defaults. If it is set to **User**, pressing **Preset** accesses a menu that allows you choose the preset settings from either the factory default values or the settings you have previously defined as the **User** preset state.

User Preset Restores the analyzer to a user defined state. The state was defined from the System menu when the Power On/Preset function was selected and Save User Preset was pressed. If you did not save a user state, then the current power-up state is stored as the user preset file for use when Preset is pressed.

Factory Preset A full factory preset is executed so the analyzer is returned to the factory default state. The preset type can be set to **Factory** from the **Power On/Preset** function in the System menu.

Mode Preset Restores the mode defaults of the current mode, or of the mode that was in use when the analyzer was turned off or powered down. See the *ESA User's/Programmer's Reference* for more details.

NOTE Limit lines and trace data are not saved in the instrument state. They must be explicitly saved using the **File** and **Save** keys, and setting **Type** to the appropriate setting.

Source

This front-panel key allows you to turn the noise source **On** or **Off** manually. It only works when you are making a Monitor Spectrum measurement.

Noise Source

Pressing this key toggles between the **On** and the **Off** settings.

On Switches the noise source **On**

Off Switches the noise source **Off**

SNS Setup

This key is used to setup how any Smart Noise Source ('SNS') is used in your noise figure measurements.

Preference Use this key to specify which type of noise source you wish to use in your measurements. Select **SNS** to use a Smart Noise Source, or **Norm** to use a normal noise source.

If you have **Preference** set to **SNS** but do not have an SNS attached, the analyzer will default to controlling a normal noise source until an SNS is attached.

Auto Load ENR This allows you to switch the SNS's auto load capability **On** or **Off**. When set to **On**, the ENR data held in the SNS will be loaded automatically every time an SNS is connected to the analyzer. Any ENR data currently held in the analyzer will be overwritten. When set to **Off**, the SNS's ENR data will not be loaded, and any pre-existing ENR data will be retained.

SPAN X Scale

- Span** Allows you to set the frequency range symmetrically about the center frequency.
- Full Span** This changes the measurement span to the full span of the analyzer. The full span of the analyzer is model dependent.
- Zero Span** This changes the measurement span of the analyzer to 0 Hz.

Sweep Menu

- Sweep Time** Allows you to specify the sweep time for the measurement or to let the analyzer set it automatically.
- Manual** This allows you to enter the sweep time manually using the knob, the numeric front panel keys, or the step keys.
 - Auto** The analyzer will determine the sweep time automatically. The sweep time will be affected by the RBW setting
- Sweep** Specifies whether the analyzer sweeps (or measures) continually, or whether it performs a single sweep and then stops.
- Single** The analyzer performs one single measurement and then stops. You have to press the **Restart** button every time you want to make another measurement.
 - Cont** The analyzer continuously measures the signal it is receiving and repeatedly updates the plots and the measurements.
- Points** Allows you to specify the number of data points used to generate the display. This is only available when performing a Monitor Spectrum measurement.

View/Trace

Accesses the view menu keys that allow you to set the way measurement result information is displayed. The menu options will vary depending on the measurement that is selected under the **Measure** menu.

Trace	Allows you to select one of the three different traces. Trace 1 displays in yellow, Trace 2 in cyan blue, and Trace 3 in magenta pink.
Clear Write	Erases any data previously stored in the selected trace and continuously displays signals during the sweep of the analyzer.
Max Hold	Maintains the maximum level for each trace point of the selected trace (1, 2 or 3), and updates each trace point if a new maximum level is detected in successive sweeps.
Min Hold	Maintains the minimum level for each trace point of the selected trace (1, 2 or 3), and updates each trace point if a new minimum level is detected in successive sweeps.
View	Holds and displays the amplitude data of the selected trace. The trace is not updated as the analyzer sweeps.
Blank	Stores the amplitude data for the selected trace and removes it from the display. The selected trace register will not be updated as the analyzer sweeps.
Graph	Displays the measurement results in the form of a graph.
Table	Displays the measurement results in the form of a table.
Meter	Displays the measurement results in the form of a textual display.
Combined	When you have chosen to view the measurement results in the form of a Graph , you can refine the view further by choosing either to combine the results in one graph, or to display the results in two separate graphs. <ul style="list-style-type: none"> On Select On to combine the measurement results in one graph on the display. Off Select Off to display the measurement results in two separate graphs on the display.
Result A	Determines the type of measurement result to be displayed in the upper graph window in Graph view, and in the left hand column in the Table and Meter views. The type of measurement result can be selected from the following list:

Noise Figure	This selects Noise Figure as the measurement result. Noise Figure (dB) Selects Noise Figure as the measurement result, and dB as the unit of measurement Noise Factor (Linear) Selects Noise Factor as the measurement result, which is a unitless measurement
Gain	This selects Gain as the measurement result.
Y-Factor	This selects Y-Factor as the measurement result.
T effective	This selects equivalent temperature as the measurement result.
Phot	This selects hot power density as the measurement result.
Pcold	This selects cold power density as the measurement result.

NOTE

Noise Factor measurements lack a unit of measurement as the results represent the ratio of two ratios, that is, they represent the ratio of the signal to noise ratio at the input signal to the signal to noise ratio at the output. **Ref Level** and **Scale/Div** values can still be entered in dB, but these values will be converted to linear values, and displayed in the results graph/table as linear values.

Conversely, **Noise Figure**, **Gain**, **Y-Factor**, **P_{hot}**, and **P_{cold}** all use dB as the unit of measurement, but **Scale/Div** and **Ref Level** can all be entered as a unitless ratio. This ratio will be automatically converted to dB for display in the Graph, Table or Meter views.

T effective results are always displayed in Kelvin. For **T effective** measurements, **Scale/Div** and **Ref Level** can be entered in Celsius (C) or Fahrenheit (F), but will be converted to Kelvin for display in the Graph, Table or Meter views.

Result B

Determines the type of measurement result to be displayed in the lower graph window in Graph view, and in the right hand column in the Table Meter views. The type of measurement result can be selected from the following list:

Noise Figure	This selects Noise Figure as the measurement result. Noise Figure (dB) Selects Noise Figure as the measurement result, and dB as the unit of measurement Noise Factor (Linear) Selects Noise Factor as the measurement result, which is a unitless measurement
---------------------	--

Gain	This selects Gain as the measurement result.
Y-Factor	This selects Y-Factor as the measurement result.
T effective	This selects equivalent temperature as the measurement result.
Phot	This selects hot power density as the measurement result.
Pcold	This selects cold power density as the measurement result.

NOTE

Noise Factor measurements lack a unit of measurement as the results represent the ratio of two ratios, that is, they represent the ratio of the signal to noise ratio at the input signal to the signal to noise ratio at the output. **Ref Level** and **Scale/Div** values can still be entered in dB, but these values will be converted to linear values, and displayed in the results graph/table as linear values.

Conversely, **Noise Figure**, **Gain**, **Y-Factor**, **P_{hot}**, and **P_{cold}** all use dB as the unit of measurement, but **Scale/Div** and **Ref Level** can all be entered as a unitless ratio. This ratio will be automatically converted to dB for display in the Graph, Table or Meter views.

T effective results are always displayed in Kelvin. For **T effective** measurements, **Scale/Div** and **Ref Level** can be entered in Celsius (C) or Fahrenheit (F), but will be converted to Kelvin for display in the Graph, Table or Meter views.

7**Language Reference**

These commands are only available when the Noise Figure mode has been selected using analyzer:SElect or analyzer:NSElect. If the Noise Figure mode is selected, commands that are unique to another mode are not available.

CALCulate Subsystem

This subsystem is used to perform post-acquisition data processing. In effect, the collection of new data triggers the CALCulate subsystem. In this instrument, the primary functions in this subsystem are markers and limits.

The SCPI default for data output format is ASCII. The format can be changed to binary with FORMat:DATA which transports faster over the bus.

Test Current Results Against all Limits

:CALCulate:CLIMits:FAIL?

Queries the status of the current measurement limit testing. It returns a 0 if the measured results pass when compared with the current limits. It returns a 1 if the measured results fail any limit tests.

Noise Figure Measurement

Noise Figure—Number of Points on a Limit Line

:CALCulate[:NFIGure]:LLINE[1] | 2 | 3 | 4:COUNT?

Queries and returns the number of sets of points in the selected limit line. One set of points comprises a frequency value (in Hz), an amplitude limit value (unitless), and a 1 or a 0 determining connectivity to the previous point.

Factory Preset: 2

Range: 0 - 101 point-sets.

Remarks: You must be in the Noise Figure mode to use this command.
Use INSTRument:SElect to set the mode.

Front Panel

Access: Display, Limits, Limit Line, Edit...

Noise Figure—Specifying Point Values for a Limit Line

:CALCulate[:NFIGure]:LLINE[1] | 2 | 3 | 4[:DATA]

**<frequency>, <amplitude>, <connected> [<frequency>, <amplitude>
, <connected>]**

:CALCulate[:NFIGure]:LLINE[1] | 2 | 3 | 4[:DATA] ?

Specify the limit line values.

The amplitude values of the limit lines have no units of their own. Instead they take on the units of the graph to which the limit line is applied. If the units of the graph are changed then the limit line values take on the new units without rescaling.

- <frequency> - is a frequency in Hz. Frequency values do not allow units (for instance, MHz) to be specified. They are always in Hz.
- <ampl> - amplitude values are unitless.
- <connected> - connected values are either 0 or 1. A 1 means this point is connected to the previously defined point to define the limit line. A 0 means this is a point of discontinuity and is not connected to the preceding point.

Limit lines 1 and 2 apply to the trace that is displayed in the upper graph. Limit lines 3 and 4 apply to the trace that is displayed in the lower graph.

Factory Preset: 10,0,1,2.65e+10,0,1

Range: 0 - 101 point-sets.

Remarks: You must be in the Noise Figure mode to use this command.
Use INSTRument:SElect to set the mode.

Front Panel

Access: Display, Limits, Limit Line, Edit...

Noise Figure—Limit Line Display Control

```
:CALCulate[:NFIGure]:LLINE[1] | 2 | 3 | 4:DISPlay[:STATe]
OFF | ON | 0 | 1
```

```
:CALCulate[:NFIGure]:LLINE[1] | 2 | 3 | 4:DISPlay[:STATe] ?
```

Turns the display of a limit line On or Off. Limit line checking still occurs even when the limit line display has been turned off.

Factory Preset: On

Remarks: You must be in the Noise Figure mode to use this command.
Use INSTRument:SElect to set the mode.

Front Panel

Access: Display, Limits, Limit Line, Edit...

NOTE

A Limit Line Display State of On will be overridden if the Limit Line State is set to Off.

Noise Figure—Limit Line State Control

```
:CALCulate[:NFIGure]:LLINE[1] | 2 | 3 | 4[:STATe] OFF | ON | 0 | 1
```

```
:CALCulate[:NFIGure]:LLINE[1] | 2 | 3 | 4[:STATe] ?
```

Turn the limit line state On or Off. When the limit line state (this command) is Off, both the display and the testing of the limit line are disabled, regardless of their individual ON/OFF settings. When the limit line state is set to On, the display and the testing of the limit line are both enabled, and their individual ON/OFF settings then come into effect.

Factory Preset: Off

Remarks: You must be in the Noise Figure mode to use this command.
Use INSTRument:SElect to set the mode.

Front Panel

Access: Display, Limits, Limit Line, Edit...

Noise Figure—Limit Line Test Control

```
:CALCulate[:NFIGure]:LLINE[1] | 2 | 3 | 4:TEST[:STATe] OFF | ON | 0 | 1
```

```
:CALCulate[:NFIGure]:LLINE[1] | 2 | 3 | 4:TEST[:STATe] ?
```

Turn the limit line trace testing On or Off for the specified limit line.

Factory Preset: Off

Remarks: You must be in the Noise Figure mode to use this command.
Use INSTRument:SElect to set the mode.

Front Panel
Access: Display, Limits, Limit Line, Edit...

NOTE

A Limit Line Test State of On will be overridden if the Limit Line State is set to Off.

Noise Figure—Limit Line Type Control

:CALCulate[:NFIGure]:LLINe[1] | 2 | 3 | 4:TYPE UPPER | LOWER

:CALCulate[:NFIGure]:LLINe[1] | 2 | 3 | 4:TYPE?

Set the limit line type. An upper limit line defines the maximum allowable value when comparing with the data, and a lower limit line defines the minimum allowable value.

Factory Preset: UPPER

Remarks: You must be in the Noise Figure mode to use this command. Use INSTRument:SElect to set the mode.

Front Panel
Access: Display, Limits, Limit Line, Edit...

Noise Figure—Marker Band Pair Mode

**:CALCulate[:NFIGure]:MARKer[1] | 2 | 3 | 4:BPAir:MODE
NORMAL:REFERENCE**

:CALCulate[:NFIGure]:MARKer[1] | 2 | 3 | 4:BPAir:MODE?

Specify which marker within a pair of linked markers (the band pair) is to be controlled using the step key and the knob.

Factory Preset: NORMAL

Remarks: You must be in the Noise Figure mode to use this command. Use INSTRument:SElect to set the mode.

Front Panel
Access: Marker, Delta Pair

Noise Figure—Marker Mode

**:CALCulate[:NFIGure]:MARKer[1] | 2 | 3 | 4:MODE
POSITION|DELTA|BPAir**

:CALCulate[:NFIGure]:MARKer[1] | 2 | 3 | 4:MODE?

Set the marker mode for the specified marker. The three valid marker modes are:

Normal (POSITION) Activates a single marker on the displayed traces. The marker's number is displayed above the marker on the display. The marker's position can be changed using the knob, the step keys, or the numeric keypad. The marker's amplitudes are updated automatically.

Language Reference

CALCulate Subsystem

DELTA	Activates a pair of delta markers on the displayed traces. Once you activate the DELTA markers, the position of the reference marker is fixed. Only the position of the delta marker can be changed.
Band Pair (BPAir)	Activates a pair of delta markers on the displayed traces. When band pair (BPAir) markers are activated, both the reference marker's position and the delta marker's position can be changed.
Factory Preset:	OFF
Remarks:	You must be in the Noise Figure mode to use this command. Use INSTRUMENT:SELEct to set the mode.
Front Panel	
Access:	Marker

Noise Figure—Marker Search Continuous

```
:CALCulate[:NFIGure]:MARKer[1] | 2 | 3 | 4:SEArch:CONTinuous  
OFF | ON | 0 | 1
```

```
:CALCulate[:NFIGure]:MARKer[1] | 2 | 3 | 4:SEArch:CONTinuous?
```

Specify whether to search continuously for maximum, minimum, or peak-to-peak points for the current marker. When set to On, a peak search is performed after every measurement sweep.

Factory Preset:	OFF
Remarks:	You must be in the Noise Figure mode to use this command. Use INSTRUMENT:SELEct to set the mode.
Front Panel	
Access:	Peak Search

Noise Figure—Marker Search Type

```
:CALCulate[:NFIGure]:MARKer[1] | 2 | 3 | 4:SEArch:TYPE  
MAXimum | MINimum | PEAK
```

```
:CALCulate[:NFIGure]:MARKer[1] | 2 | 3 | 4:SEArch:TYPE?
```

Specify the type of search performed by the specified marker. The three valid types of search are:

MAXimum	Searches for and finds the highest peak on the trace. This is not valid when the marker mode is set to Band Pair.
MINimum	Searches for and finds the lowest trough on the trace. This is not valid when the marker mode is Band Pair
PEAK	When a peak search is performed, the Band Pair markers are placed on the highest and the lowest points of the trace. The reference marker is placed on the highest point of the trace, and

the delta marker on the lowest.

Factory Preset: MAXimum

Remarks: You must be in the Noise Figure mode to use this command.
 Use INSTRument:SElect to set the mode.

All of these searches can be made continuous by switching Continuous to ON (See “Noise Figure—Marker Search Continuous” on page 244.), or by repeatedly pressing the ‘Find...’ softkey.

Front Panel

Access: Peak Search

Noise Figure—Marker State

:CALCulate[:NFIGure]:MARKer [1] | 2 | 3 | 4[:STATE] OFF|ON|0|1

:CALCulate[:NFIGure]:MARKer [1] | 2 | 3 | 4[:STATE] ?

Turn the specified marker On or Off.

Factory Preset: Marker 1 - On

Markers 2, 3, and 4 - Off

Remarks: You must be in the Noise Figure mode to use this command.
 Use INSTRument:SElect to set the mode.

Front Panel

Access: **Marker**

Noise Figure—Marker X Position

:CALCulate[:NFIGure]:MARKer [1] | 2 | 3 | 4:X <freq>

:CALCulate[:NFIGure]:MARKer [1] | 2 | 3 | 4:X?

Set the X-axis position of the specified marker on the trace. When setting the X-axis position, the unit of measurement is assumed to be Hz unless you specify otherwise. When querying the X-axis position, the result is always returned in Hz.

Factory Preset: None

Range Same as the measurement range

Remarks: You must be in the Noise Figure mode to use this command.
 Use INSTRument:SElect to set the mode.

Front Panel

Access: Peak Search

Noise Figure—Marker Y Position**:CALCulate[:NFIGure]:MARKer[1] | 2 | 3 | 4:Y?**

Return two comma-separated values representing the current marker's positions on the two traces. Each value is in the Y-axis unit of the relevant trace.

Factory Preset: None

Range Same as the measurement range

Remarks: You must be in the Noise Figure mode to use this command.
Use INSTRument:SElect to set the mode.

Front Panel

Access: **TAB** (until the marker table becomes visible)**Noise Figure—DUT Gain****:CALCulate:UNCertainty:DUT:GAIN <value>****:CALCulate:UNCertainty:DUT:GAIN?**

Specify the measured gain of the Device Under Test (DUT).

Factory Preset: 20.00 dB

Range -100 dB to 100 dB

Remarks: You must be in the Noise Figure mode to use this command.
Use INSTRument:SElect to set the mode.

Front Panel

Access: Mode Setup, Uncertainty Calculator...

Noise Figure—DUT Input Match**:CALCulate:UNCertainty:DUT:MATCH:INPut <value>****:CALCulate:UNCertainty:DUT:MATCH:INPut?**

Specify the measured Input Match of the Device Under Test (DUT).

Factory Preset: 1.500

Range -100 to 100

Remarks: You must be in the Noise Figure mode to use this command.
Use INSTRument:SElect to set the mode.

Front Panel

Access: Mode Setup, Uncertainty Calculator...

NOTE

The unit of measurement, which can be dB, VSWR (Voltage Standing Wave Ratio) or Reflection Coefficient, is calculated from the input value. Negative values are assumed to be return loss in dB, values equal to or greater than 1 represent VSWR, and values greater than or equal to zero and less than 1 represent the reflection coefficient.

Noise Figure—DUT Output Match

:CALCulate:UNCertainty:DUT:MATCH:OUTPut <value>

:CALCulate:UNCertainty:DUT:MATCH:OUTPut?

Specify the measured Output Match of the Device Under Test (DUT).

Factory Preset: 1.500

Range -100 to 100

Remarks: You must be in the Noise Figure mode to use this command.
Use INSTRUMENT:SElect to set the mode.

Front Panel

Access: Mode Setup, Uncertainty Calculator...

NOTE

The unit of measurement, which can be dB, VSWR (Voltage Standing Wave Ratio) or Reflection Coefficient, is determined by the input value. Negative values are assumed to be return loss in dB, values equal to or greater than 1 represent VSWR, and values greater than or equal to zero and less than 1 represent the reflection coefficient.

Noise Figure—DUT Noise Figure

:CALCulate:UNCertainty:DUT:NFIGure <value>

:CALCulate:UNCertainty:DUT:NFIGure?

Specify the measured Noise Figure of the Device Under Test (DUT).

Factory Preset: 3.0 dB

Range -100 dB to 100 dB

Remarks: You must be in the Noise Figure mode to use this command.
Use INSTRUMENT:SElect to set the mode.

Front Panel

Access: Mode Setup, Uncertainty Calculator...

Noise Figure—Instrument Gain

:CALCulate:UNCertainty:INSTRument:GAIN <value>

:CALCulate:UNCertainty:INSTRument:GAIN?

Specify the gain of the spectrum analyzer. The Instrument Gain is set by default to a pre-calculated value of 0.5 dB for the ESA-E series.

Factory Preset: 0.83 dB

Range -100 dB to 100 dB

Remarks: You must be in the Noise Figure mode to use this command.
Use INSTRUMENT:SElect to set the mode.

Language Reference
CALCulate Subsystem

Front Panel
 Access: Mode Setup, Uncertainty Calculator...

Noise Figure—Instrument Match

:CALCulate:UNCertainty:INSTRument:MATCh <value>

:CALCulate:UNCertainty:INSTRument:MATCh?

Specify the measured Match of the spectrum analyzer. The Instrument Match is set by default to a pre-calculated VSWR value of 1.60.

Factory Preset: 1.6000

Range -100 to 100

Remarks: You must be in the Noise Figure mode to use this command.
 Use INSTRument:SELEct to set the mode.

Front Panel
 Access: Mode Setup, Uncertainty Calculator...

NOTE

The unit of measurement, which can be dB, VSWR (Voltage Standing Wave Ratio) or Reflection Coefficient, is determined by the input value. Negative values are assumed to be return loss in dB, values equal to or greater than 1 represent VSWR, and values greater than or equal to zero and less than 1 represent the reflection coefficient.

Noise Figure—Instrument Noise Figure

:CALCulate:UNCertainty:INSTRument:NFIGure <value>

:CALCulate:UNCertainty:INSTRument:NFIGure?

Specify the measured Noise Figure of the spectrum analyzer. The default setting is 8.0 dB for the ESA-E series of analyzers. More appropriate values can be found in the specifications guides.

Factory Preset: 8.0 dB

Range -100 dB to 100 dB

Remarks: You must be in the Noise Figure mode to use this command.
 Use INSTRument:SELEct to set the mode.

Front Panel
 Access: Mode Setup, Uncertainty Calculator...

Noise Figure—Instrument Noise Figure Uncertainty

:CALCulate:UNCertainty:INSTRument:NFIGure:UNCertainty <value>

:CALCulate:UNCertainty:INSTRument:NFIGure:UNCertainty?

Specify the measured Noise Figure Uncertainty of the spectrum analyzer. The

default setting of 0.41 dB is good for most measurements.

Factory Preset: 0.41 dB

Range -100 dB to 100 dB

Remarks: You must be in the Noise Figure mode to use this command.
Use INSTRUMENT:SElect to set the mode.

Front Panel

Access: Mode Setup, Uncertainty Calculator...

Noise Figure—RSS Uncertainty

:CALCulate:UNCertainty:RSS?

Query and return the Root Sum Squared (RSS) Uncertainty value. The RSS Uncertainty value, expressed in dB, is a measure of the overall uncertainty of your noise figure measurement. It is calculated from all the individual uncertainty parameters known to the analyzer. An indicated RSS Uncertainty value of x dB means that your measurement's uncertainty is $\pm x$ dB.

Factory Preset: Calculated

Range Any positive value < 100 dB

Remarks: You must be in the Noise Figure mode to use this command.
Use INSTRUMENT:SElect to set the mode.

Front Panel

Access: Mode Setup, Uncertainty Calculator...

Noise Figure—Noise Source ENR Uncertainty

:CALCulate:UNCertainty:SOURce:ENR <value>

:CALCulate:UNCertainty:SOURce:ENR?

Set the Excess Noise Ratio (ENR) Uncertainty of your noise source.

Factory Preset: 0.20 dB

Range -100 dB to 100 dB

Remarks: You must be in the Noise Figure mode to use this command.
Use INSTRUMENT:SElect to set the mode.

Front Panel

Access: Mode Setup, Uncertainty Calculator...

NOTE

The ENR Uncertainty can only be modified when your noise source is User Defined. For greatest accuracy, set your noise source to User Defined, and enter the value specific to your noise source.

Noise Figure—Noise Source Match

:CALCulate:UNCertainty:SOURce:MATCh <value>

Language Reference
CALCulate Subsystem

:CALCulate:UNCertainty:SOURce:MATCh?

Set the Match of your noise source.

Factory Preset: 1.1500

Range -100 to 100

Remarks: You must be in the Noise Figure mode to use this command.
 Use INSTRument:SElect to set the mode.

Front Panel

Access: Mode Setup, Uncertainty Calculator...

NOTE The unit of measurement, which can be dB, VSWR (Voltage Standing Wave Ratio) or Reflection Coefficient, is determined by the input value. Negative values are assumed to be return loss in dB, values equal to or greater than 1 represent VSWR, and values greater than or equal to zero and less than 1 represent the reflection coefficient.

NOTE The Noise Source Match can only be modified when your noise source is User Defined.

Noise Figure—Noise Source Match**:CALCulate:UNCertainty:SOURce:TYPE <value>****:CALCulate:UNCertainty:SOURce:TYPE?**

Specify the type of noise source you will be using for your measurements. The six pre-defined noise sources (Agilent Technologies' Smart Noise Source models N4000A, N4001A and N4002A, and Agilent Technologies' normal noise source models 346A, 346B and 346C) have pre-defined match and uncertainty figures which cannot be changed. Only by selecting a source type of USER (user defined) can you change the match and uncertainty figures.

Factory Preset: 346B

Range USER|346A|346B|346C|N4000A|N4001A|N4002A

Remarks: You must be in the Noise Figure mode to use this command.
Use INSTRument:SElect to set the mode.

Front Panel

Access: Mode Setup, Uncertainty Calculator...

CONFigure Subsystem

The CONFigure commands are used with several other commands to control the measurement process. The full set of commands is described in the section “MEASure Group of Commands” on page 276.

Selecting measurements with the CONFigure/FETCH/MEASure/READ commands sets the instrument state to the defaults for that measurement and to make a single measurement. Other commands are available for each measurement to allow you to change: settings, view, limits, etc. Refer to:

SENSe:<measurement>, SENSe:CHANnel, SENSe:CORRection,
SENSe:DEFaults, SENSe:DEViation, SENSe:FREQUency, SENSe:PACKet,
SENSe:POWer, SENSe:RADio, SENSe:SYNC
CALCulate:<measurement>, CALCulate:CLIMits
DISPlay:<measurement>
TRIGger

The INITiate[:IMMediate] or INITiate:REStart commands will initiate the taking of measurement data without resetting any of the measurement settings that you have changed from their defaults.

Configure the Selected Measurement

:CONFigure:<measurement>

A CONFigure command must specify the desired measurement. It will set the instrument settings for that measurement’s standard defaults, but should not initiate the taking of data. The available measurements are described in the MEASure subsystem.

NOTE This command sets Averaging to On and sets the number of averages to 10.

Configure Query

:CONFigure?

The CONFigure query returns the name of the current measurement.

DISPlay Subsystem

The DISPlay controls the selection and presentation of textual, graphical, and TRACe information. Within a DISPlay, information may be separated into individual WINDows.

Full Screen Display

```
:DISPlay:FSCReen[:STATe] OFF|ON|0|1
```

```
:DISPlay:FSCReen[:STATe]?
```

For Noise Figure Mode only:

```
:DISPlay:FSCREEN|FULLSCREEN[:STATe] ON|OFF|1|0
```

```
:DISPlay:FSCREEN|FULLSCREEN[:STATe]?
```

When the full screen function is activated, the measurement window expands horizontally over the entire instrument display. That is, it turns off the display of the softkey labels. Pressing any other key that results in a new menu will cancel the full screen function.

State Saved: Not saved in state.

Factory Preset: Off

Factory
Default: Off

Front Panel
Access: **Display**

Example: DISP:FSCR ON

Set the Display Line Level

```
:DISPlay:MONitor:WINDow:TRACe:Y:DLINe <power>
```

```
:DISPlay:MONitor:WINDow:TRACe:Y:DLINe?
```

Sets the vertical position of the display line.

Factory Preset: -25 dBm

Range: -170 dBm to 30 dBm

Default Unit: dBm

Remarks: You must be in Noise Figure to use this command. Use :INSTrument:SElect to set the mode.

Language Reference
DISPlay Subsystem

Front Panel

Access: When in Monitor Spectrum measurement, **Display**

Set the Display Line State

:DISPlay:MONitor:WINDow:TRACe:Y:DLINe:STATe ON|OFF|1|0

:DISPlay:MONitor:WINDow:TRACe:Y:DLINe:STATe?

Enables or disables the display line.

Factory Preset: OFF

Remarks: You must be in Noise Figure to use this command. Use
 :INSTrument:SElect to set the mode.

Front Panel

Access: When in Monitor Spectrum measurement, **Display**

Set the Y-Axis Scale per Division

:DISPlay:MONitor:WINDow:TRACe:Y[:SCALe]:PDIVision <dB>

:DISPlay:MONitor:WINDow:TRACe:Y[:SCALe]:PDIVision?

Set the Y-axis scale per division.

Factory Preset: 10 dB

Range: 0.1 dB to 20 dB

Remarks: You must be in Noise Figure to use this command. Use
 :INSTrument:SElect to set the mode.

Front Panel

Access: When in Monitor Spectrum measurement, **Amplitude**

Set the Reference Level

:DISPlay:MONitor:WINDow:TRACe:Y[:SCALe]:RLEVel <dB>

:DISPlay:MONitor:WINDow:TRACe:Y[:SCALe]:RLEVel?

Set the amplitude reference level for the Y-axis. The reference level is the amplitude power represented by the top graticule on the display.

Factory Preset: -45 dBm (automatically adjusted according to power)

Range: Without pre-amp, or pre-amp OFF: -149.9 dBm to +30 dBm

With pre-amp ON: -149.9 dBm to -10 dBm

Remarks: You must be in Noise Figure to use this command. Use :INSTrument:SELEct to set the mode.

Front Panel

Access: When in Monitor Spectrum measurement, **Amplitude**

Set Display Annotation On/Off

:DISPlay[:NFIGure]:ANNotation[:STATE] ON|OFF|1|0

:DISPlay[:NFIGure]:ANNotation[:STATE] ?

Turns the display of the annotation on or off.

Factory Preset: ON

Remarks: You must be in Noise Figure to use this command. Use :INSTrument:SELEct to set the mode.

Front Panel

Access: **Display, Preferences**

Date and Time Display

:DISPlay[:NFIGure]:ANNotation:CLOCK:DATE:FORMat MDY|DMY

:DISPlay[:NFIGure]:ANNotation:CLOCK:DATE:FORMat ?

Allows you to set the format for displaying the real-time clock. To set the date time use **:SYSTEM:DATE <year>, <month>, <day>**.

Factory Preset: DMY

Remarks: This parameter is persistent, which means that it retains the setting previously selected, even through a power cycle.

Front Panel

Access: **System, Time/Date, Date Format MDY DMY**

Date and Time Display

:DISPlay[:NFIGure]:ANNotation:CLOCK[:STATE] OFF|ON|0|1

:DISPlay[:NFIGure]:ANNotation:CLOCK[:STATE] ?

Turns on and off the display of the date and time on the spectrum analyzer screen. The time and date pertain to all windows.

Factory Preset: On

Remarks: This parameter is persistent, which means that it retains the

setting previously selected, even through a power cycle.

Front Panel

Access: **System, Time/Date, Time/Date On Off**

Noise Figure Corrections

```
:DISPlay[:NFIGure]:DATA:CORRections[:STATe] ON|OFF|1|0
```

```
:DISPlay[:NFIGure]:DATA:CORRections[:STATe]?
```

Enables or disables the display of corrected data. An error will be returned if a user calibration has not been performed prior to issuing this command.

Factory Preset: ON

Remarks: You must be in Noise Figure to use this command. Use :INSTrument:SElect to set the mode.

Front Panel

Access: **Input, Noise Figure Corrections**

Select Results for Display (A)

```
:DISPlay[:NFIGure]:DATA:TRACe[1]  
NFIGure|NFACTor|GAIN|YFACTor|TEFFective|PHOT|PCOLd
```

```
:DISPlay[:NFIGure]:DATA:TRACe[1]?
```

Selects the type of measurement results to be displayed in the upper display window when in graph view, or in the center column in the table or meter views. The seven types of result are:

- NFIGure - Noise figure
- NFACTor - Noise factor (linear noise figure)
- GAIN - Gain
- YFACTor - Y-factor
- PHOT - Hot power density
- PCOLd - Cold power density

Factory Preset: NFIGure

Range: NFIGure, NFACTor, GAIN, YFACTor, TEFFective, PHOT or PCOLd

Remarks: You must be in Noise Figure to use this command. Use :INSTrument:SElect to set the mode.

Front Panel

Access: **View, Result A**

Select Results for Display (B)

```
:DISPlay[:NFIGure]:DATA:TRACe2  
NFIGure|NFACTor|GAIN|YFACTor|TEFFective|PHOT|PCOLd
```

```
:DISPlay[:NFIGure]:DATA:TRACe[1]?
```

Selects the type of measurement results to be displayed in the lower display window when in graph view, or in the right column in the table or meter views. The seven types of result are:

- NFIGure - Noise figure
- NFACTor - Noise factor (linear noise figure)
- GAIN - Gain
- YFACTor - Y-factor
- PHOT - Hot power density
- PCOLd - Cold power density

Factory Preset: NFIGure

Range: NFIGure, NFACTor, GAIN, YFACTor, TEFFective, PHOT or PCOLd

Remarks: You must be in Noise Figure to use this command. Use :INSTrument:SElect to set the mode.

Front Panel

Access: **View, Result B**

Select Results Format

```
:DISPlay[:NFIGure]:DATA:FORMat GRAPH|TABLE|METer
```

```
:DISPlay[:NFIGure]:DATA:FORMat?
```

Selects the format in which the measurement results will be displayed. It is not necessary to capture new data when you change the results format. This means that you can capture data in a single sweep, and then view this data in any of the three views.

- GRAPH - Displays the results graphically
- TABLE - Displays the results in a table with one line per discrete frequency
- METer - Displays the results at one specified frequency

Factory Preset: GRAPH

Remarks: You must be in Noise Figure to use this command. Use :INSTRument:SElect to set the mode.

Front Panel

Access: **View**

Set Graticule On or Off

```
:DISPlay[:NFIGure]:GRATicule[:STATe] ON|OFF|1|0
```

```
:DISPlay[:NFIGure]:GRATicule[:STATe]?
```

Specifies whether or not the graticule lines will be displayed.

Factory Preset: ON

Remarks: You must be in Noise Figure to use this command. Use :INSTRument:SElect to set the mode.

Front Panel

Access: **Display, Preferences**

Set Graph View

```
:DISPlay[:NFIGure]:TRACe:COMBined[:STATe] ON|OFF|1|0
```

```
:DISPlay[:NFIGure]:TRACe:COMBined[:STATe]?
```

Specifies whether the two graph traces are displayed on separate graphs or in one combined graph with two scales.

- ON - Both traces are displayed on one graph with two scales
- OFF - The two graphs are displayed separately on the screen

Factory Preset: OFF

Remarks: You must be in Noise Figure to use this command. Use :INSTrument:SElect to set the mode.

Front Panel
Access: **View**

Noise Figure - Set the Y-Axis Scale per Division

```
:DISPlay[:NFIGure]:TRACe:Y[:SCALe]:PDIVision <result>,  
<value>
```

```
:DISPlay[:NFIGure]:TRACe:Y[:SCALe]:PDIVision?
```

Set the Y-axis scale per division for the specified graph window. The graph window is determined by the <result> setting, which can be one of:

- NFIGure — Noise Figure
- NFACTor — Noise Factor
- GAIN — Gain
- YFACTor — Y-Factor
- TEFFective — Effective Temp
- PHOT — Hot Power Density
- PCOLd — Cold Power Density

If the graph window that you have specified with this command is not visible, the new scaling will take effect the next time that the window is displayed.

Factory Preset: Presets are dependent on the <result> setting as follows:

- Noise Figure — 1.0 dB
- Noise Factor — 0.74189
- Gain — 5.0 dB
- Y Factor — 1.0 dB
- Effective Temp — 200 K
- Hot Power Density — 1.0 dB
- Cold Power Density — 1.0 dB

Range: The ranges are dependent on the <result> setting as follows:

- Noise Figure — 0.001 dB to 20 dB
- Noise Factor — 0.001 to 100
- Gain — 0.001 dB to 20 dB

Language Reference
DISPlay Subsystem

- Y Factor — 0.001 dB to 20 dB
- Effective Temp — 0.1 K to 20,000,000 K
- Hot Power Density — 0.001 dB to 20 dB
- Cold Power Density — 0.001 dB to 20 dB

Remarks: You must be in Noise Figure to use this command. Use :INSTRUMENT:SElect to set the mode.

Front Panel

Access: **Amplitude**

Noise Figure - Set the Y-Axis Reference Value

```
:DISPlay[:NFIGure]:TRACe:Y[:SCALE]:RLEVEL:VALue <result>,
<value>
```

```
:DISPlay[:NFIGure]:TRACe:Y[:SCALE]:RLEVEL:VALue?
```

Set the Y-axis reference value for the specified graph window. The graph window is determined by the <result> setting, which can be one of:

- NFIGure — Noise Figure
- NFACTOR — Noise Factor
- GAIN — Gain
- YFACTOR — Y-Factor
- TEFFECTive — Effective Temp
- PHOT — Hot Power Density
- PCOLD — Cold Power Density

If the graph window that you have specified with this command is not visible, the new reference value will take effect the next time that the window is displayed.

Factory Preset: Presets are dependent on the <result> setting as follows:

- Noise Figure — 4.0 dB
- Noise Factor — 2.51189
- Gain — 15.0 dB
- Y Factor — 5.0 dB
- Effective Temp — 1000 K
- Hot Power Density — 5.0 dB
- Cold Power Density — 5.0 dB

Range: The ranges are dependent on the <result> setting as follows:

- Noise Figure — -100 dB to 100 dB
- Noise Factor — 0 to 1×10^9
- Gain — -100 dB to 100 dB
- Y Factor — -100 dB to 100 dB
- Effective Temp — -100,000,000 K to 100,000,000 K
- Hot Power Density — -100 dB to 100 dB
- Cold Power Density — -100 dB to 100 dB

Remarks: You must be in Noise Figure to use this command. Use :INSTrument:SELEct to set the mode.

Front Panel

Access: **Amplitude**

Noise Figure - Set the Y-Axis Reference Position

```
:DISPlay[:NFIGure]:TRACe:Y[:SCALe]:RPOsition <result>,
<value>
```

```
:DISPlay[:NFIGure]:TRACe:Y[:SCALe]:RPOsition?
```

Set the Y-axis reference position for the specified graph window. The graph window is determined by the <result> setting, which can be one of:

- NFIGure — Noise Figure
- NFACTOR — Noise Factor
- GAIN — Gain
- YFACTOR — Y-Factor
- TEFFECTive — Effective Temp
- PHOT — Hot Power Density
- PCOLD — Cold Power Density

If the graph window that you have specified with this command is not visible, the new reference position will take effect the next time that the window is displayed.

Factory Preset: CENTER for all <result> settings

Range: TOP|CENTER|BOTTom for all <result> settings

Remarks: You must be in Noise Figure to use this command. Use :INSTrument:SELEct to set the mode.

Front Panel

Access: **Amplitude**

Zoom Window

:DISPlay: [NFIGure] :ZOOM:WINDow OFF | UPPer | LOWer

:DISPlay: [NFIGure] :ZOOM:WINDow?

Selects the upper or lower window and expands it to fill the entire display.

- **OFF** — Returns the display to dual display.
- **UPPer** — Zoom the upper window.
- **LOWer** — Zoom the lower window.

Factory Preset: **OFF**

Remarks: You must be in Noise Figure to use this command. Use
:INSTrument:SElect to set the mode.

Front Panel

Access: **Next Window, Zoom**

FETCh Subsystem

The FETCh? queries are used with several other commands to control the measurement process. These commands are described in the section on the “MEASure Group of Commands” on page 276. These commands apply only to measurements found in the MEASURE menu.

This command puts selected data from the most recent measurement into the output buffer (new data is initiated/measured). Use FETCh if you have already made a good measurement and you want to look at several types of data (different [n] values) from the single measurement. FETCh saves you the time of re-making the measurement. You can only fetch results from the measurement that is currently active.

If you need to make a new measurement, use the READ command, which is equivalent to an INITiate[:IMMediate] followed by a FETCh.

:FETCh <meas>? will return valid data only when the measurement is in one of the following states:

- idle
- initiated
- paused

Fetch the Current Measurement Results

:FETCh: <measurement> [n] ?

A FETCh? command must specify the desired measurement. It will return the valid results that are currently available, but will not initiate the taking of any new data. You can only fetch results from the measurement that is currently selected. The code number n selects the kind of results that will be returned. The available measurements and data results are described in the “MEASure Group of Commands” on page 276.

FORMat Subsystem

The FORMat subsystem sets a data format for transferring numeric and array information.

Byte Order

:FORMat:BORDER NORMAL | SWAPped

:FORMat:BORDER?

Selects the binary data byte order for numeric data transfer. In normal mode the most significant byte is sent first. In swapped mode the least significant byte is first. (PCs use the swapped order.) Binary data byte order functionality does not apply to ASCII.

This command selects the binary data byte order for data transfer. It controls whether binary data is transferred in normal or swapped mode. This command affects only the byte order for setting and querying trace data for the command :TRACe[:DATA] and query :TRACe[:DATA]?

NOTE

Normal mode is when the byte sequence begins with the most significant byte (MSB) first, and ends with the least significant byte (LSB) last in the sequence: 1|2|3|4. Swapped mode is when the byte sequence begins with the LSB first, and ends with the MSB last in the sequence: 4|3|2|1.

Factory Preset: Normal

Remarks: You must be in the Spectrum Analysis, Basic, cdma2000, 1xEV-DO, W-CDMA, GSM (w/EDGE), NADC, PDC, or Noise Figure mode to use this command. Use INSTRument:SElect to set the mode.

Numeric Data Format

:FORMat [:TRACe] [:DATA] ASCii | REAL [, 32]

:FORMat [:TRACe] [:DATA] ?

This command changes the format of the trace data input and output. The command affects only the data format for setting and querying trace data for the command :TRACe[:DATA] and query :TRACe[:DATA]?

NOTE

This command specifies the formats used for trace data during data transfer across any remote port.

For corrected trace data (:TRACe[:DATA] with parameter <trace_name>), REAL and ASCii formats will provide trace data in the current amplitude units. INTeger format will provide trace data in mdBm. The fastest mode is INTeger,32.

For uncorrected trace data (:TRACe[:DATA] with parameter RAWTRACE), UINteger and INTeger formats apply to RAWTRACE queries, and return uncorrected ADC values. The fastest mode is UINteger,16.

For state data, the format cannot be changed. It is always in a machine readable format only.

Corrected Trace Data Types :TRACe:DATA?<trace_name>	
Data Type	Result
ASCii	Display Units
INT,32 (fastest)	Internal Units
REAL,32	Display Units
REAL,64	Display Units

Uncorrected Trace Data Types :TRACe:DATA? RAWTRACE	
Data Type	Result
INT,32	Uncorrected ADC Values
UINt,16 (fastest)	Uncorrected ADC Values

ASCII - Amplitude values are in ASCII, in amplitude units, separated by commas. ASCII format requires more memory than the binary formats. Therefore, handling large amounts of this type of data, will take more time and storage space.

Integer,16 - Binary 16-bit integer values in internal units (dBm), in a definite length block. **PSA, SA mode only.

Integer,32 - Binary 32-bit integer values in internal units (dBm), in a definite length block.

Real,32 or Real,64 - Binary 32-bit (or 64-bit) real values in amplitude unit, in a definite length block. Transfers of real data are done in a binary block format.

UINteger,16 - Binary 16-bit unsigned integer that is uncorrected ADC values, in a definite length block.

Language Reference
FORMat Subsystem

A definite length block of data starts with an ASCII header that begins with # and indicates how many additional data points are following in the block. Suppose the header is #512320.

- The first digit in the header (5) tells you how many additional digits/bytes there are in the header.
- The 12320 means 12 thousand, 3 hundred, 20 data bytes follow the header.
- Divide this number of bytes by your selected data format bytes/point, either 8 (for real 64), or 4 (for real 32). In this example, if you are using real 64 then there are 1540 points in the block.

Example: FORM REAL,64

Factory Preset: Real,32

Remarks: The acceptable settings for this command change for the different modes as described above.

INITiate Subsystem

The INITiate subsystem is used to initiate a trigger for a measurement. These commands only initiate measurements from the MEASURE front panel key or the “MEASure Group of Commands” on page 276. Refer also to the TRIGger and ABORt subsystems for related commands.

Take New Data Acquisition for Selected Measurement

:INITiate:<measurement>

This command initiates a trigger cycle for the measurement specified, but does not return data. The valid measurement names are described in the MEASure subsystem.

If your selected measurement is not currently active, the instrument will change to the measurement in your INIT:<meas> command and initiate a trigger cycle.

This command is only available in the noise figure and phase noise mode.

Example: INIT:NFIG

Continuous or Single Measurements

:INITiate:CONTinuous OFF|ON|0|1

:INITiate:CONTinuous?

When set to ON another trigger cycle is initiated at the completion of each measurement.

When set to OFF, the trigger system remains in the “idle” state until an INITiate[:IMMediate] command is received. On receiving the INITiate[:IMMediate] command, it will go through a single trigger/measurement cycle, and then return to the “idle” state.

This command affects sweep in normal spectrum analyzer mode, and affects trigger when in a measurement. A “measurement” refers to any of the functions under the MEASURE key. This corresponds to continuous sweep or single sweep operation when not in a measurement, and continuous measurement or single measurement operation when in a measurement.

NOTE

When not in a measurement, this command does the following:

- When ON at the completion of each sweep cycle, the sweep system immediately initiates another sweep cycle.
- When OFF, the sweep system remains in the “idle” state until an :INITiate[:IMMEDIATE] command is received. On receiving the :INITiate[:IMMEDIATE] command, it will go through a single sweep cycle, and then return to the “idle” state.
- The query returns 1 or 0 into the output buffer. 1 is returned when there is continuous sweeping. 0 is returned when there is only a single sweep.

When in a measurement, this command does the following:

- When ON, at the completion of each trigger cycle, the trigger system immediately initiates another trigger cycle.
 - When OFF, the trigger system remains in an “idle” state until CONTinuous is set to ON or an :INITiate[:IMMEDIATE] command is received. On receiving the :INITiate[:IMMEDIATE] command, it will go through a single trigger cycle, and then return to the “idle” state.
 - The query returns 1 or 0 into the output buffer. 1 is returned when there is continuous triggering. 0 is returned when there is only a single trigger.
-

Example: INIT:CONT ON

Factory Preset: On

*RST: On (OFF is recommended for remote operation)

Front Panel

Access: **Single**

Take New Data Acquisitions

:INITiate[:IMMEDIATE]

This command initiates a sweep if not in a measurement. If in a measurement and the measurement is in the idle state (i.e. not running), it triggers the instrument if trigger conditions are met. If the measurement is currently running, the command is ignored. A “measurement” refers to any function under the MEASURE key.

Example: INIT:IMM

Remarks: See also the *TRG command and the TRIGger subsystem.

Use the [:SENSe]:<meas>:TRIGger:SOURce command to select the desired trigger. The instrument must be in the single measurement mode. If :INITiate:CONTinuous is ON then the command is ignored.

Use `:FETCh?` to transfer a measurement result from memory to the output buffer. Refer to individual commands in the FETCh subsystem for more information.

Front Panel

Access:

Sweep, Sweep Cont Single

Single

Meas Control, Measure Cont Single

Pause the Measurement

:INITiate:PAUSE

Pauses the current measurement by changing the current measurement state from the “wait for trigger” state to the “paused” state. If the measurement is not in the “wait for trigger” state, when the command is issued, the transition will be made the next time that state is entered as part of the trigger cycle. When in the paused state, the spectrum analyzer auto-align process stops. If the analyzer is paused for a long period of time, measurement accuracy may degrade.

Example: INIT:PAUS

Front Panel

Access:

Meas Control, Pause

Restart the Measurement

:INITiate:REStart

This command applies to measurements found in the MEASURE menu. It restarts the current measurement from the “idle” state regardless of its current operating state. It is equivalent to:

INITiate[:IMMEDIATE]

ABORt (for continuous measurement mode)

Example: INIT:REST

Front Panel

Access: **Restart**

or

Meas Control, Restart

Resume the Measurement

:INITiate:RESume

Resumes the current measurement by changing the current measurement state from the “paused state” back to the “wait for trigger” state. If the measurement is not in the “paused” state, when the command is issued, an error is reported.

Example: INIT:RES

Front Panel

Access: **Meas Control, Resume**

INPut Subsystem

The INPut subsystem controls the characteristics of all the instrument input ports.

RF Attenuation Setting

```
:INPut[:NFIGure]:ATTenuation <power>
```

```
:INPut[:NFIGure]:ATTenuation
```

Sets the attenuation value for the RF/Microwave input.

NOTE

This command has the same effect as

```
:SENSe:NFIGure:MANual:RF|:MWAVE:FIXed <power>
```

Factory Preset: 0 dB

Range: 0 dB to 40 dB in 4 dB steps on PSA

0 dB to 40 dB in 5 dB steps on ESA

Never lower than the Min. RF Attenuation setting, and never higher than the Max. RF Attenuation.

Front Panel

Access: **Input, Attenuation**

Maximum Microwave Attenuation Setting

```
:INPut[:NFIGure]:ATTenuation:MWAVE:MAXimum <integer>
```

```
:INPut[:NFIGure]:ATTenuation:MWAVE:MAXimum
```

See “Maximum RF Attenuation Setting” on page 272.

NOTE

This command gives backwards compatibility with Agilent Technologies’ Noise Figure Analyzers (NFAs). It is functionally identical to the command

```
:INPut[:NFIGure]:ATTenuation[:RF]:MAXimum <integer>
```

Minimum Microwave Attenuation Setting

```
:INPut[:NFIGure]:ATTenuation:MWAVE:MINimum <integer>
```

```
:INPut[:NFIGure]:ATTenuation:MWAVE:MINimum
```

See “Minimum RF Attenuation Setting” on page 272.

NOTE

This command gives backwards compatibility with Agilent Technologies’ Noise

Figure Analyzers (NFAs). It is functionally identical to the command

```
:INPut [:NFIGure] :ATTenuation[:RF] :MINimum <integer>
```

Maximum RF Attenuation Setting

```
:INPut [:NFIGure] :ATTenuation[:RF] :MAXimum <integer>
```

```
:INPut [:NFIGure] :ATTenuation[:RF] :MAXimum
```

Sets the maximum RF attenuation setting when a calibration is performed.

Use this command and the minimum RF attenuation command to limit the attenuation range used during calibration. See [“Minimum RF Attenuation Setting” on page 272](#).

Factory Preset: 0 dB

Range: 0 dB to 40 dB in 4 dB steps on PSA

0 dB to 40 dB in 5 dB steps on ESA

Never lower than the Min. RF Attenuation setting.

Front Panel

Access: **Input, Noise Figure Corrections, Input Cal**

Minimum RF Attenuation Setting

```
:INPut [:NFIGure] :ATTenuation[:RF] :MINimum <integer>
```

```
:INPut [:NFIGure] :ATTenuation[:RF] :MINimum
```

Sets the minimum RF attenuation setting when a calibration is performed.

Use this command and the maximum RF attenuation command to limit the attenuation range used during calibration. See [“Maximum RF Attenuation Setting” on page 272](#).

Factory Preset: 0 dB

Range: 0 dB to 40 dB in 4 dB steps on PSA

0 dB to 40 dB in 5 dB steps on ESA

Never higher than the Max. RF Attenuation.

Front Panel

Access: **Input, Noise Figure Corrections, Input Cal**

RF Input Port Coupling

:INPut:COUPling AC|DC

:INPut:COUPling? AC|DC

Selects AC or DC coupling for the front panel RF INPUT port. A blocking capacitor is switched in for the ac mode.

CAUTION

Instrument damage can occur if there is a DC component present at the RF INPUT and DC coupling is selected.

- Factory Preset
- ESA model E4401 - AC
 - ESA model E4402B (without Opt. UKB) - AC
 - ESA model E4402B (with Opt. UKB) - AC
 - ESA model E4404B - AC
 - ESA model E4405B - AC
 - ESA model E4407B (without Opt. UKB) - DC
 - ESA model E4402B (with Opt. UKB) - AC

Remarks:

Front Panel
 Access:

Input/Output (or Input), Coupling AC DC

INSTRUMENT Subsystem

This subsystem includes commands for querying and selecting instrument measurement (personality option) modes.

Select Application by Number

:INSTRUMENT:NSELECT <integer>

:INSTRUMENT:NSELECT?

Select the measurement mode by its instrument number. The actual available choices depends upon which applications are installed in the instrument.

1 = SA
3 = GSM
4 = CDMA (cdmaOne)
14 = PNOISE (phase noise)
219 = NOISE FIGURE
228 = BLUETOOTH
227 = CATV (Cable TV)
229 = MAN (Modulation Analysis)
231 = LINK (89600 VSA Link Software)

NOTE

If you are using the SCPI status registers and the analyzer mode is changed, the status bits should be read, and any errors resolved, prior to switching modes. Error conditions that exist prior to switching modes cannot be detected using the condition registers after the mode change. This is true unless they recur after the mode change, although transitions of these conditions can be detected using the event registers.

Changing modes resets all SCPI status registers and mask registers to their power-on defaults. Hence, any event or condition register masks must be re-established after a mode change. Also note that the power up status bit is set by any mode change, since that is the default state after power up.

Example: INST:NSEL 4
Factory Preset: Persistent state with factory default of 1
Range: 1 to x, where x depends upon which applications are installed.
Front Panel
Access: **MODE**

Select Application

:INSTRUMENT[:SELECT] 'SA' | 'GSM' | 'CDMA' | 'PNOISE' | 'BLUETOOTH' | 'MAN' | 'LINK' | 'CATV' | 'NFIGURE'

:INSTrument [:SElect] ?

Select the measurement mode. The actual available choices depend upon which modes (measurement applications) are installed in the instrument. A list of the valid choices is returned with the INST:CAT? query.

Once an instrument mode is selected, only the commands that are valid for that mode can be executed.

1 = SA
3 = GSM
4 = CDMA (cdmaOne)
14 = PNOISE (phase noise)
219 = NOISE FIGURE
228 = BLUETOOTH
227 = CATV (Cable TV)
229 = MAN (Modulation Analysis)
231 = LINK (89600 VSA Link Software)

NOTE

If you are using the status bits and the analyzer mode is changed, the status bits should be read, and any errors resolved, prior to switching modes. Error conditions that exist prior to switching modes cannot be detected using the condition registers after the mode change. This is true unless they recur after the mode change, although transitions of these conditions can be detected using the event registers.

Changing modes resets all SCPI status registers and mask registers to their power-on defaults. Hence, any event or condition register masks must be re-established after a mode change. Also note that the power up status bit is set by any mode change, since that is the default state after power up.

Example: INST:SEL 'CDMA'

Factory Preset: Persistent state with factory default of Spectrum Analyzer mode

Front Panel

Access: **MODE**

MEASure Group of Commands

This group includes the CONFigure, FETCh, MEASure, and READ commands that are used to make measurements and return results. The different commands can be used to provide fine control of the overall measurement process, like changing measurement parameters from their default settings. Most measurements should be done in single measurement mode, rather than measuring continuously.

The SCPI default for the format of any data output is ASCII. The format can be changed to binary with FORMat:DATA which transports faster over the bus.

Command Interactions: MEASure, CONFigure, FETCh, INITiate and READ

Figure 7-1 Measurement Group of Commands

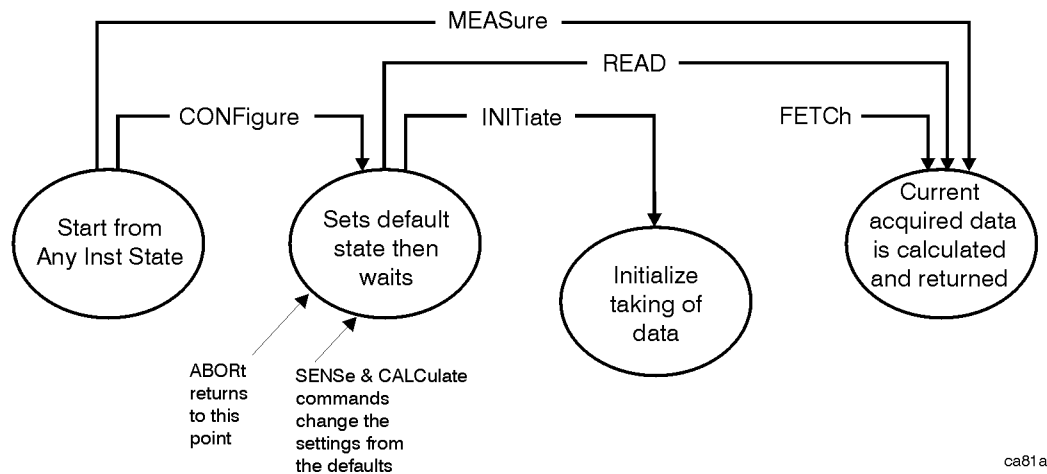

Measure Commands:

:MEASure:<measurement> [n] ?

This is a fast single-command way to make a measurement using the factory default instrument settings. These are the settings and units that conform to the Mode Setup settings (e.g. radio standard) that you have currently selected.

- Stops the current measurement (if any) and sets up the instrument for the specified measurement using the factory defaults
- Initiates the data acquisition for the measurement
- Blocks other SCPI communication, waiting until the measurement is complete before returning results.
- *ESA-E Series only:* If the function does averaging, it is turned on and the number of averages is set to 10.
- After the data is valid it returns the scalar results, or the trace data, for the specified measurement. The type of data returned may be defined by an [n] value that is sent with the command.

The scalar measurement results will be returned if the optional [n] value is not included, or is set to 1. If the [n] value is set to a value other than 1, the selected trace data results will be returned. See each command for details of what types of scalar results or trace data results are available.

ASCII is the default format for the data output. (Older versions of Spectrum Analysis and Phase Noise mode measurements only use ASCII.) The binary data formats should be used for handling large blocks of data since they are smaller and faster than the ASCII format. Refer to the FORMat:DATA command for more information.

If you need to change some of the measurement parameters from the factory default settings you can set up the measurement with the CONFigure command. Use the commands in the SENSE:<measurement> and CALCulate:<measurement> subsystems to change the settings. Then you can use the READ? command to initiate the measurement and query the results. See [Figure 7-1](#).

If you need to repeatedly make a given measurement with settings other than the factory defaults, you can use the commands in the SENSE:<measurement> and CALCulate:<measurement> subsystems to set up the measurement. Then use the READ? command to initiate the measurement and query results.

Measurement settings persist if you initiate a different measurement and then return to a previous one. Use READ:<measurement>? if you want to use those persistent settings. If you want to go back to the default settings, use MEASure:<measurement>?.

Configure Commands:

:CONFigure:<measurement>

This command stops the current measurement (if any) and sets up the instrument for the specified measurement using the factory default instrument settings. It sets the instrument to single measurement mode but should not initiate the taking of measurement data unless INIT:CONTinuous is ON. After you change any measurement settings, the READ command can be used to initiate a measurement without changing the settings back to their defaults. *ESA-E Series only:* The CONFigure command also turns the averaging function on and sets the number of averages to 10 for all measurements.

The CONFigure? query returns the current measurement name.

Fetch Commands:**:FETCh:<measurement> [n] ?**

This command puts selected data from the most recent measurement into the output buffer. Use FETCh if you have already made a good measurement and you want to return several types of data (different [n] values, e.g. both scalars and trace data) from a single measurement. FETCh saves you the time of re-making the measurement. You can only FETCh results from the measurement that is currently active, it will not change to a different measurement.

If you need to get new measurement data, use the READ command, which is equivalent to an INITiate followed by a FETCh.

The scalar measurement results will be returned if the optional [n] value is not included, or is set to 1. If the [n] value is set to a value other than 1, the selected trace data results will be returned. See each command for details of what types of scalar results or trace data results are available. The binary data formats should be used for handling large blocks of data since they are smaller and transfer faster than the ASCII format. (FORMat:DATA)

FETCh may be used to return results other than those specified with the original READ or MEASure command that you sent.

INITiate Commands:**:INITiate:<measurement>**

This command is not available for measurements in all the instrument modes:

- Initiates a trigger cycle for the specified measurement, but does not output any data. You must then use the FETCh<meas> command to return data. If a measurement other than the current one is specified, the instrument will switch to that measurement and then initiate it.

For example, suppose you have previously initiated the ACP measurement, but now you are running the channel power measurement. If you send INIT:ACP? it will change from channel power to ACP and will initiate an ACP measurement.

- Does not change any of the measurement settings. For example, if you have previously started the ACP measurement and you send INIT:ACP? it will initiate a new ACP measurement using the same instrument settings as the last time ACP was run.
- If your selected measurement is currently active (in the idle state) it triggers the measurement, assuming the trigger conditions are met. Then it completes one trigger cycle. Depending upon the measurement and the number of averages, there may be multiple data acquisitions, with multiple trigger events, for one full trigger cycle. It also holds off additional commands on GPIB until the acquisition is complete.

READ Commands:

:READ:<measurement> [n] ?

- Does not preset the measurement to the factory default settings. For example, if you have previously initiated the ACP measurement and you send READ:ACP? it will initiate a new measurement using the same instrument settings.
- Initiates the measurement and puts valid data into the output buffer. If a measurement other than the current one is specified, the instrument will switch to that measurement before it initiates the measurement and returns results.

For example, suppose you have previously initiated the ACP measurement, but now you are running the channel power measurement. Then you send READ:ACP? It will change from channel power back to ACP and, using the previous ACP settings, will initiate the measurement and return results.

- Blocks other SCPI communication, waiting until the measurement is complete before returning the results

If the optional [n] value is not included, or is set to 1, the scalar measurement results will be returned. If the [n] value is set to a value other than 1, the selected trace data results will be returned. See each command for details of what types of scalar results or trace data results are available. The binary data formats should be used when handling large blocks of data since they are smaller and faster than the ASCII format.
(FORMat:DATA)

Monitor Spectrum

This measures the power levels across the specified spectral band using one of three traces. By default, the analyzer's entire range is measured.

The general functionality of **CONFigure**, **FETCh**, **MEASure**, and **READ** are described at the beginning of this section. See the **SENSe:MONitor** commands for more measurement related commands.

:CONFigure:MONitor

:FETCh:MONitor [n]

:READ:MONitor [n]

:MEASure:MONitor [n]

Front Panel

Access: **Measure, Monitor Spectrum**

After the measurement is selected, press
Restore Meas Defaults to restore factory defaults.

Measurement Results Available

n	Results Returned
n=1 (or not specified)	Trace 1 data if available, otherwise nothing
2	Trace 2 data if available, otherwise nothing
3	Trace 3 data if available, otherwise nothing

Noise Figure Measurement

This returns a set of thirteen noise figure measurement results in a specified order and separated by commas. The order in which the thirteen results are returned is shown in the table below, and they represent the last data measured in the last measurement sweep that was made.

You must be in Noise Figure mode to use these commands. Use `INSTrument:SElect` to set the mode.

The general functionality of `CONFigure`, `FETCh`, `MEASure`, and `READ` are described at the beginning of this section.

:CONFigure [:NFIGure]

:INITiate [:NFIGure]

:FETCh [:NFIGure] ?

:READ [:NFIGure] ?

:MEASure [:NFIGure] ?

Front Panel

Access: **Measure, Noise Figure, View/Trace**

After the measurement is selected, press **Restore Meas Defaults** to restore factory defaults.

Measurement Results Returned
Returns the following scalar results, in order.
1. T_{cold} scalar value
2. Corrected scalar result for Noise Figure
3. Corrected scalar result for Noise Factor
4. Corrected scalar result for Gain
5. Corrected scalar result for Effective Temperature
6. Corrected scalar result for Hot Power Density
7. Corrected scalar result for Cold Power Density
8. Uncorrected scalar result for Noise Figure
9. Uncorrected scalar result for Noise Factor
10. Uncorrected scalar result for Gain
11. Uncorrected scalar result for Effective Temperature
12. Uncorrected scalar result for Hot Power Density
13. Uncorrected scalar result for Cold Power Density

Noise Figure Measurement - Gain Results

Returns the Gain values used in calculating the measurement results. The returned values are in the default units of dB.

Sweep results are returned as a list of comma separated values, one value for each measurement frequency.

You must be in Noise Figure mode to use these commands. Use INSTRument:SElect to set the mode.

The general functionality of CONFigure, FETCh, MEASure, and READ are described at the beginning of this section.

```
:FETCh[:NFIGure]([:ARRay] | :SCALar) [:DATA] :CORReCted:GAIN?
```

```
:READ[:NFIGure]([:ARRay] | :SCALar) [:DATA] :CORReCted:GAIN?
```

```
:MEASure[:NFIGure]([:ARRay] | :SCALar) [:DATA] :CORReCted:GAIN?
```

Front Panel

Access: **Measure, Noise Figure, View/Trace**

After the measurement is selected, press **Restore Meas Defaults** to restore factory defaults.

Noise Figure Measurement - Noise Factor Results

Returns the Noise Factor values used in calculating the measurement results. The returned values are linear.

Sweep results are returned as a list of comma separated values, one value for each measurement frequency.

You must be in Noise Figure mode to use these commands. Use INSTRument:SELect to set the mode.

The general functionality of CONFigure, FETCh, MEASure, and READ are described at the beginning of this section.

:FETCh[:NFIGure] ([:ARRay] | :SCALar) [:DATA] (:CORReCted | :UNCORReCted) :NFACTor?

:READ[:NFIGure] ([:ARRay] | :SCALar) [:DATA] (:CORReCted | :UNCORReCted) :NFACTor?

:MEASure[:NFIGure] ([:ARRay] | :SCALar) [:DATA] (:CORReCted | :UNCORReCted) :NFACTor?

Front Panel

Access:

Measure, Noise Figure, View/Trace

After the measurement is selected, press **Restore Meas Defaults** to restore factory defaults.

Noise Figure Measurement - Noise Figure Results

Returns the Noise Figure values used in calculating the measurement results. The returned values are in the default units of dB.

Sweep results are returned as a list of comma separated values, one value for each measurement frequency.

You must be in Noise Figure mode to use these commands. Use INSTRument:SElect to set the mode.

The general functionality of CONFigure, FETCh, MEASure, and READ are described at the beginning of this section.

```
:FETCh[:NFIGure] ([:ARRay] | :SCALar) [:DATA] (:CORReCted | :UNCORReCted) :NFIGure?
```

```
:READ[:NFIGure] ([:ARRay] | :SCALar) [:DATA] (:CORReCted | :UNCORReCted) :NFIGure?
```

```
:MEASure[:NFIGure] ([:ARRay] | :SCALar) [:DATA] (:CORReCted | :UNCORReCted) :NFIGure?
```

Front Panel

Access: **Measure, Noise Figure, View/Trace**

After the measurement is selected, press **Restore Meas Defaults** to restore factory defaults.

Noise Figure Measurement - Cold Power P_{cold} Density Results

Return the Cold Power values from the most recently completed swept frequency measurement. The returned values are in the default units of dB.

The instrument makes cold power measurements with the noise source switched off. The reported value is a power level which is relative to the power at the input.

Sweep results are returned as a list of comma separated values, one value for each measurement frequency.

You must be in Noise Figure mode to use these commands. Use `INSTrument:SElect` to set the mode.

The general functionality of `CONFigure`, `FETCh`, `MEASure`, and `READ` are described at the beginning of this section.

```
:FETCh[:NFIGure] ([:ARRay] | :SCALar) [:DATA] (:CORReCted | :UNCORReCted) :PCOLd?
```

```
:READ[:NFIGure] ([:ARRay] | :SCALar) [:DATA] (:CORReCted | :UNCORReCted) :PCOLd?
```

```
:MEASure[:NFIGure] ([:ARRay] | :SCALar) [:DATA] (:CORReCted | :UNCORReCted) :PCOLd?
```

Front Panel

Access: **Measure, Noise Figure, View/Trace**

After the measurement is selected, press **Restore Meas Defaults** to restore factory defaults.

Noise Figure Measurement - Hot Power P_{hot} Density Results

Return the Hot Power values from the most recently completed swept frequency measurement. The returned values are in the default units of dB.

The instrument makes hot power measurements with the noise source switched on. The reported value is a power level which is relative to the power at the input.

Sweep results are returned as a list of comma separated values, one value for each measurement frequency.

You must be in Noise Figure mode to use these commands. Use INSTRUMENT:SELect to set the mode.

The general functionality of CONFigure, FETCh, MEASure, and READ are described at the beginning of this section.

```
:FETCh[:NFIGure] ([:ARRay] | :SCALar) [:DATA] (:CORReCted | :UNCORreCted) :PHOT?
```

```
:READ[:NFIGure] ([:ARRay] | :SCALar) [:DATA] (:CORReCted | :UNCORreCted) :PHOT?
```

```
:MEASure[:NFIGure] ([:ARRay] | :SCALar) [:DATA] (:CORReCted | :UNCORreCted) :PHOT?
```

Front Panel

Access: **Measure, Noise Figure, View/Trace**

After the measurement is selected, press **Restore Meas Defaults** to restore factory defaults.

Noise Figure Measurement - Effective Temperature Results

Return the Effective Temperature values from the most recently completed swept frequency measurement. The returned values are in the default units of degrees Kelvin.

Sweep results are returned as a list of comma separated values, one value for each measurement frequency.

You must be in Noise Figure mode to use these commands. Use INSTRUMENT:SElect to set the mode.

The general functionality of CONFigure, FETCh, MEASure, and READ are described at the beginning of this section.

:FETCh[:NFIGure] ([:ARRay] | :SCALar) [:DATA] (:CORREcted | :UNCORREcted) :TEFFective?

:READ[:NFIGure] ([:ARRay] | :SCALar) [:DATA] (:CORREcted | :UNCORREcted) :TEFFective?

:MEASure[:NFIGure] ([:ARRay] | :SCALar) [:DATA] (:CORREcted | :UNCORREcted) :TEFFective?

Front Panel

Access: **Measure, Noise Figure, View/Trace**

After the measurement is selected, press **Restore Meas Defaults** to restore factory defaults.

Noise Figure Measurement - T_{cold} Results

Return the T_{cold} values used in calculating the measurement results. The results returned are from the most recently completed swept measurement if :ARRAY has been selected, or from the most recently completed fixed measurement if :SCALAR has been selected. The returned values are in the default units of degrees Kelvin.

Sweep results are returned as a list of comma separated values, one value for each measurement frequency.

You must be in Noise Figure mode to use these commands. Use INSTRUMENT:SELECT to set the mode.

The general functionality of CONFIGure, FETCh, MEASure, and READ are described at the beginning of this section.

:FETCh [:NFIGure] ([:ARRAY] | :SCALAR) [:DATA] :TCOLd?

:READ [:NFIGure] ([:ARRAY] | :SCALAR) [:DATA] :TCOLd?

:MEASure [:NFIGure] ([:ARRAY] | :SCALAR) [:DATA] :TCOLd?

Front Panel

Access: **Measure, Noise Figure, View/Trace**

After the measurement is selected, press **Restore Meas Defaults** to restore factory defaults.

Noise Figure Measurement - Y Factor Results

Return the Y Factor values from the most recently completed swept frequency measurement. The results returned are from the most recently completed swept measurement if :ARRay has been selected, or from the most recently completed fixed measurement if :SCALar has been selected. The returned values are in the default units of dB.

Sweep results are returned as a list of comma separated values, one value for each measurement frequency.

You must be in Noise Figure mode to use these commands. Use INSTRument:SELEct to set the mode.

The general functionality of CONFigure, FETCh, MEASure, and READ are described at the beginning of this section.

```
:FETCh[:NFIGure] ([:ARRay] | :SCALar) [:DATA] :UNCorrected  
:YFACTOR?
```

```
:READ[:NFIGure] ([:ARRay] | :SCALar) [:DATA] :UNCorrected  
:YFACTOR?
```

```
:MEASure[:NFIGure] ([:ARRay] | :SCALar) [:DATA] :UNCorrected  
:YFACTOR?
```

Front Panel

Access:

Measure, Noise Figure, View/Trace

After the measurement is selected, press **Restore Meas Defaults** to restore factory defaults.

MMEMory Subsystem

The purpose of the MMEMory subsystem is to provide access to mass storage devices such as internal or external disk drives. If mass storage is not specified in the filename, the default mass storage will be used.

NOTE Refer also to :CALCulate and :TRACe subsystems for more trace and limit line commands.

Agilent ESA analyzers use two types of mass storage devices:

- 3.5 inch disk drive (high density, 1.44 MBytes formatted) designated “A:”
- Part of flash memory and treated as a device designated “C:”

The MMEMory command syntax term <file_name> is a specifier having the form: drive:name.ext, where the following rules apply:

- “drive” is “A:” or “C:”
- “name” is a DOS file name of up to eight characters, letters (A-Z, a-z) and numbers (0-9) only (lower case letters are read as uppercase)
- “ext” is an optional file extension using the same rules as “name,” but consists of up to three characters total. (The default file extension will be added if it is not specified.)

Load a Noise Figure ENR Table from a File

:MMEMory:LOAD:ENR CALibration|MEASurement, <file_name>

Loads the ENR data in the file <file_name> to the specified correction set.

Example: :MMEM:LOAD:ENR MEASurements, “A:TEST.ENR”

Front Panel

Access: **File, Load, Type, More, ENR Cal Table or
File, Load, Type, More, ENR Meas/Common Table**

Load a Noise Figure Frequency List Table from a File

:MMEMory[:NFIGure]:LOAD:FREQuency, <file_name>

Loads the frequency data in the file <filename> to the frequency table.

Example: :MMEM:LOAD:FREQuency, “A:TEST.LST”

Front Panel

Access: **File, Load, Type, More, More, Freq List**

Load a Limit Line from Memory to the Instrument

```
:MMEMory:LOAD:LIMit LLINE1 | LLINE2 | LLINE3 | LLINE4, <file_name>
```

Loads a limit line, from the specified file in mass storage to the instrument. Loading a time limit line deletes any frequency limit lines. Similarly, loading a frequency limit line deletes any time limit lines. If you do not specify the file extension, the instrument will assume your file has an extension of .LIM. If your file has no extension, the instrument will not find the file.

Example: `:MMEM:LOAD:LIM LLIN2, "C:mylimit.lim"`

Front Panel

Access: **File, Load, Type, Limits**

Load a Noise Figure Loss Compensation Table from a File

```
:MMEMory:LOAD:LOSS BEFOre | AFTEr, <file_name>
```

Loads the Loss Compensation data in the file <file_name> to the specified loss compensation table.

Example: `:MMEM:LOAD:LOSS BEFOre, "A:TEST.LOS"`

Front Panel

Access: **File, Load, Type, More, Loss Comp Before DUT or
File, Load, Type, More, Loss Comp After DUT**

Store a Noise Figure ENR Table to a File

```
:MMEMory:STORE:ENR CALibration | MEASurement, <file_name>
```

Stores the ENR calibration or measurement data to the file <file_name>.

Example: `:MMEM:STORE:ENR MEASurement, "A:TEST.ENR"`

Front Panel

Access: **File, Store, Type, More, ENR Cal Table or
File, Store, Type, More, ENR Meas/Common Table**

Store a Limit Line in a File

```
:MMEMory:STORE:LIMit LLINE1 | LLINE2, <file_name>
```

```
:MMEMory:STORE:LIMit  
LLINE1 | LLINE2 | LLINE3 | LLINE4, <file_name>
```

Stores the current limit line to the specified file in memory. If you do not specify the file extension, the instrument will assign an extension of .LIM.

Language Reference
MMEMory Subsystem

Example: MMEM:STOR:LIM LLIN2,"C:mylimit.lim"
 Remarks: This command will fail if the <file_name> already exists. There is no SCPI short form for parameters LLINE1|LLINE2.

Front Panel
 Access: **File, Save, Type**

Store a Noise Figure Frequency List Table to a File

:MMEMory[:NFIGure]:STORe:FREQUency, <file_name>

Stores the frequency data in the specified Frequency table to the file <file_name>.

Example: :MMEM:STORe:FREQUency, "A:TEST.LST"

Front Panel
 Access: **File, Save, Type, More, More, Freq List**

Store a Noise Figure Loss Compensation Table to a File

:MMEMory:STORe:LOSS BEFore|AFTer, <file_name>

Stores the Loss Compensation data in the specified Loss Compensation table to the file <file_name>.

Example: :MMEM:STORe:LOSS BEFore, "A:TEST.LOS"

Front Panel
 Access: **File, Save, Type, More, Loss Comp Before DUT or
 File, Save, Type, More, Loss Comp After DUT**

Store a Measurement Results in a File

:MMEMory:STORe:RESults filename.csv

Saves the measurement results to a file in memory. The file name must have a file extension of .csv and will be in the CSV (comma-separated values) format.

Example: MMEM:STOR:RES 'C:mymeas.csv'

Front Panel
 Access: **File, Save, Type, Measurement Results**

Store a Trace in a File

For Signal Analysis mode:

```
:MMEMory:STORe:TRACe TRACe1|TRACe2|TRACE3|ALL, <file_name>
```

For Noise Figure mode:

```
:MMEMory:STORe:TRACe TRACe1|TRACe2|ALL, <file_name>
```

Stores the specified trace or traces to the specified file in memory. The file is in comma separated value (CSV) format, with the data stored in <frequency>/<amplitude> pairs.

Example: MMEM:STOR:TRAC TRACE2,“C:mytrace.trc”

Front Panel

Access: **File, Save, Type**

OUTPut Subsystem

The OUTPut subsystem controls the characteristics of the source output port.

ESA series only: Commands for controlling the tracking generator output are found under SOURce:POWer.

Turn Noise Source On/Off

:OUTPut:MONitor:NOISe[:STATe] OFF|ON|0|1

:OUTPut:MONitor:NOISe[:STATe]?

Turns the noise source On or Off.

Factory Preset: Off

Front Panel

Access: **Source**

READ Subsystem

The READ? commands are used with several other commands and are documented in the section on the “MEASure Group of Commands” on page 276.

Initiate and Read Measurement Data

:READ:<measurement> [n] ?

A READ? query must specify the desired measurement. It will cause a measurement to occur without changing any of the current settings and will return any valid results. The code number n selects the kind of results that will be returned. The available measurements and data results are described in the “MEASure Group of Commands” on page 276.

SENSe Subsystem

These commands are used to set the instrument state parameters so that you can measure a particular input signal. Some SENSe commands are only for use with specific measurements found under the MEASURE key menu or the [“MEASure Group of Commands” on page 276](#). The measurement must be active before you can use these commands.

The SCPI default for the format of any data output is ASCII. The format can be changed to binary with FORMat:DATA which transports faster over the bus.

Bandwidth Commands

Resolution Bandwidth

```
[[:SENSe]:MONitor:BANDwidth|BWIDth[:RESolution] <freq>
```

```
[[:SENSe]:MONitor:BANDwidth|BWIDth[:RESolution] ?
```

Enables you to select the 3.01 dB resolution bandwidth (RBW) of the analyzer in steps from 1 Hz to 5 MHz in a 1:3:10 sequence.

If an unavailable bandwidth is specified, the closest available bandwidth is selected.

Sweep time is coupled to RBW. As the RBW changes, the sweep time (if set to **Auto**) is changed to maintain amplitude calibration.

Factory Preset: 3 MHz

Range 1 Hz to 5 MHz.

Default Unit: Hz

Front Panel

Access: **BW/Avg**

Video Bandwidth

```
[[:SENSe]:MONitor:BANDwidth|BWIDth:VIDeo <freq>
```

```
[[:SENSe]:MONitor:BANDwidth|BWIDth:VIDeo?
```

Specifies the video bandwidth.

You can change the analyzer post-detection filter from 1 Hz to 3 MHz in a 1:3:10 sequence.

Factory Preset: Automatically calculated

Range 1 Hz to 3 MHz

Default Unit: Hz

Front Panel

Access: **BW/Avg**

Video Bandwidth Automatic

```
[[:SENSe]:MONitor:BANDwidth|BWIDth:VIDeo:AUTO OFF|ON|0|1
```

```
[[:SENSe]:MONitor:BANDwidth|BWIDth:VIDeo:AUTO?
```

Couples the video bandwidth to the resolution bandwidth, using the VBW/RBW ratio that you have set.

Factory Preset: ON

Language Reference
SENSe Subsystem

Front Panel
Access: **BW/Avg**

Video to Resolution Bandwidth Ratio

`[[:SENSe]:MONitor:BANDwidth|BWIDth:VIDeo:RATio <numeric>`

`[[:SENSe]:MONitor:BANDwidth|BWIDth:VIDeo:RATio?`

Specifies the ratio of the video bandwidth to the resolution bandwidth. The knob and the step keys change the ratio in a 1, 3, 10 sequence.

Factory Preset: 1.0
Range: 0.00001 to 10
Front Panel
Access: **BW/Avg**

Configure Commands

Downconverter Fixed LO Frequency

```
[ :SENSe ] :CONFigure:MODE:DOWNconv:LOSCillator:FREQuency  
<value>
```

```
[ :SENSe ] :CONFigure:MODE:DOWNconv:LOSCillator:FREQuency?
```

Sets the down converter fixed LO frequency.

NOTE

This noise figure application (Option 219) can only measure fixed LO devices.

Factory Preset: 30 GHz

Range: 1 Hz to 325 GHz

Default Unit: Hz

Remarks: You must be in the Noise Figure mode to use this command.
Use INSTRument:SElect to set the mode.

Front Panel

Access: **Mode Setup, DUT Setup**

Downconverter Frequency Context

```
[ :SENSe ] :CONFigure:MODE:DOWNconv:FREQuency:CONText RF | IF
```

```
[ :SENSe ] :CONFigure:MODE:DOWNconv:FREQuency:CONText?
```

Determines whether the frequencies are displayed before any downconversion has taken place (RF), or after any downconversion (IF). It is only when the frequency context is set to IF that the displayed frequencies represent the actual frequencies that the analyzer is measuring.

RF - Frequencies are displayed as they are when they enter the DUT, that is, before any frequency conversion has taken place.

IF - Frequencies are displayed as they are when they leave the DUT, that is, after any frequency conversion has taken place. These are therefore the frequencies entering the analyzer.

Factory Preset: IF

Remarks: You must be in the Noise Figure mode to use this command.
Use INSTRument:SElect to set the mode.

Front Panel

Access: **Mode Setup, DUT Setup**

Downconverter LO Offset

```
[ :SENSe ] :CONFIgure:MODE:DOWNconv:LOSCillator:OFFSet
LSB | USB | DSB
```

```
[ :SENSe ] :CONFIgure:MODE:DOWNconv:LOSCillator:OFFSet?
```

Sets the type of offset for the downconverter.

LSB - Lower Sideband (Signal frequency < LO frequency).

USB - Upper Sideband (Signal frequency > LO frequency)

DSB - Double sideband (no offset).

Factory Preset: LSB

Remarks: You must be in the Noise Figure mode to use this command.
Use INSTRument:SELEct to set the mode.

Remarks: You must have specified the DUT type as Downconverter to use this command. Use [:SENSe]:CONFIgure:MODE:DUT to set the DUT type.

Front Panel

Access: **Mode Setup, DUT Setup**

Select DUT type

```
[ :SENSe ] :CONFIgure:MODE:DUT AMPLifier | DOWNconv | UPConv
```

```
[ :SENSe ] :CONFIgure:MODE:DUT?
```

Sets the type of DUT whose noise figure is to be measured.

AMPLifier - the DUT is an amplifier that performs no frequency conversion. It can be used with or without an external system downconverter.

DOWNconv - the DUT performs its own frequency downconversion. A DOWNconverter cannot be used with an external system downconverter.

UPConv - the DUT performs its own frequency upconversion. An upconverter cannot be used with an external system downconverter.

Factory Preset: AMPLifier

Remarks: You must be in the Noise Figure mode to use this command.
Use INSTRument:SELEct to set the mode.

Front Panel

Access: **Mode Setup, DUT Setup**

System Downconverter Control

```
[ :SENSe] :CONFigure:MODE:SYSTem:DOWNconv[:STATE] ON|OFF|1|0
[ :SENSe] :CONFigure:MODE:SYSTem:DOWNconv[:STATE] ?
```

Specifies whether or not there is a system downconverter. A system downconverter reduces high frequencies that are beyond the range of the analyzer to a lower frequency which the analyzer can measure.

ON or 1 - you are using a system downconverter.

OFF or 0 - you are not using a system downconverter.

Factory Preset: OFF

Remarks: You must be in the Noise Figure mode to use this command. Use INSTRUMENT:SElect to set the mode.

Remarks: Your DUT must be set to type AMPLifier. Use [:SENSe]:CONFigure:MODE:DUT to set the DUT type.

Front Panel

Access: **Mode Setup, DUT Setup**

System Fixed LO Frequency

```
[ :SENSe] :CONFigure:MODE:SYSTem:LOSCillator:FREQUENCY
<value>
```

```
[ :SENSe] :CONFigure:MODE:SYSTem:LOSCillator:FREQUENCY?
```

Sets the system fixed LO frequency.

NOTE

This noise figure application (Option 219) can only measure fixed LO devices.

Factory Preset: 30 GHz

Range: 1 Hz to 325 GHz

Default Unit: Hz

Remarks: You must be in the Noise Figure mode to use this command. Use INSTRUMENT:SElect to set the mode.

Front Panel

Access: **Mode Setup, DUT Setup**

System Frequency Context

```
[ :SENSe ] :CONFIgure:MODE:SYSTem:FREQuency:CONText RF | IF
```

```
[ :SENSe ] :CONFIgure:MODE:SYSTem:FREQuency:CONText?
```

Determines whether the frequencies are displayed before any conversion has taken place (RF), or after any conversion (IF). It is only when the frequency context is set to IF that the displayed frequencies represent the actual frequencies that the analyzer is measuring.

RF - Frequencies are displayed as they are when they enter the DUT, that is, before any frequency conversion by the system downconverter has taken place.

IF - Frequencies are displayed as they are when they leave the DUT, that is, after any frequency conversion has taken place. These are therefore the frequencies entering the analyzer.

Factory Preset: RF

Remarks: You must be in the Noise Figure mode to use this command.
Use INSTRument:SELEct to set the mode.

Front Panel

Access: **Mode Setup, DUT Setup**

System LO Offset

```
[ :SENSe ] :CONFIgure:MODE:SYSTem:LOSCillator:OFFSet  
LSB | USB | DSB
```

```
[ :SENSe ] :CONFIgure:MODE:SYSTem:LOSCillator:OFFSet?
```

Sets the type of offset for the system.

LSB - Lower Sideband (Signal frequency < LO frequency).

USB - Upper Sideband (Signal frequency > LO frequency)

DSB - Double sideband (no offset).

Factory Preset: LSB

Remarks: You must be in the Noise Figure mode to use this command.
Use INSTRument:SELEct to set the mode.

Remarks: Double Sideband (DSB) is only available when the System Downconverter is On.

Front Panel

Access: **Mode Setup, DUT Setup**

Upconverter Fixed LO Frequency

`[:SENSE] :CONFigure:MODE:UPConv:LOSCillator:FREQuency <value>`

`[:SENSe] :CONFigure:MODE:UPConv:LOSCillator:FREQuency?`

Sets the upconverter fixed LO frequency.

NOTE

This noise figure application (Option 219) can only measure fixed LO devices.

Factory Preset: 30 GHz

Range: 1 Hz to 325 GHz

Default Unit: Hz

Remarks: You must be in the Noise Figure mode to use this command.
Use INSTRument:SElect to set the mode.

Front Panel

Access: **Mode Setup, DUT Setup**

Upconverter Frequency Context

`[:SENSe] :CONFigure:MODE:UPConv:FREQuency:CONText RF | IF`

`[:SENSe] :CONFigure:MODE:UPConv:FREQuency:CONText?`

Determines whether the frequencies are displayed before any upconversion has taken place (RF), or after any upconversion (IF). It is only when the frequency context is set to IF that the displayed frequencies represent the actual frequencies that the analyzer is measuring.

RF - Frequencies are displayed as they are when they enter the DUT, that is, before any frequency conversion by the upconverter has taken place.

IF - Frequencies are displayed as they are when they leave the DUT, that is, after any frequency conversion has taken place. These are therefore the frequencies entering the analyzer.

Factory Preset: IF

Remarks: You must be in the Noise Figure mode to use this command.
Use INSTRument:SElect to set the mode.

Front Panel

Access: **Mode Setup, DUT Setup**

Upconverter LO Offset

```
[ :SENSe ] :CONFigure:MODE:UPConv:LOSCillator:OFFSet LSB|USB
```

```
[ :SENSe ] :CONFigure:MODE:UPConv:LOSCillator:OFFSet?
```

Sets the type of offset for the system.

LSB - Lower Sideband (Signal frequency < LO frequency).

USB - Upper Sideband (Signal frequency > LO frequency)

Factory Preset: LSB

Remarks: You must be in the Noise Figure mode to use this command.
Use INSTRument:SELEct to set the mode.

Front Panel

Access: **Mode Setup, DUT Setup**

Default Reset

[:SENSe] :DEFaults

Restores personality Mode Setup defaults.

Front Panel

Access: **Mode Setup**

Remarks: This command sets all the SENSe defaults but has no effect on the MEASure default settings. Use the CONFigure:<measurement> command to set measurement defaults

Monitor Spectrum or Monitor Band/Channel Measurement

Commands for querying the monitor spectrum or monitor band/channel measurement results and for setting to the default values are found in the “MEASure Group of Commands” on page 276. The equivalent front panel keys for the parameters described in the following commands, are found under the **Meas Setup** key, after the **Monitor Spectrum** or **Monitor Band/Channel** measurement has been selected from the **MEASURE** key menu.

Monitor Spectrum or Monitor Band/Channel—Average Count

```
[ :SENSe ] :MONitor :AVERage :COUNT <integer>
```

```
[ :SENSe ] :MONitor :AVERage :COUNT?
```

Set the number of data acquisitions that will be averaged. After the specified number of average counts, the averaging mode (terminal control) setting determines the averaging action.

Factory Preset: 10

Range: 1 to 1,000

Remarks: You must be in the Bluetooth, cdmaOne, GSM, Modulation Analysis, Noise Figure or Phase Noise mode to use this command. Use INSTRUMENT:SElect to set the mode.

Front Panel

Access: **Meas Setup, Avg Number**

Monitor Spectrum or Monitor Band/Channel—Averaging State

```
[ :SENSe ] :MONitor :AVERage [ :STATe ] OFF | ON | 0 | 1
```

```
[ :SENSe ] :MONitor :AVERage [ :STATe ] ?
```

Turn averaging on or off.

Factory Preset: On for GSM, Bluetooth

Off for cdmaOne, Modulation Analysis, Phase Noise and Noise Figure.

Remarks: You must be in the Bluetooth, cdmaOne, GSM, Modulation Analysis, Noise Figure or Phase Noise mode to use this command. Use INSTRUMENT:SElect to set the mode.

Front Panel

Access: **Meas Setup, Avg Number**

Monitor Spectrum or Monitor Band/Channel—Averaging Termination Control

```
[ :SENSe ] :MONitor :AVERage :TCONtrol EXPonential | REPEAT
```

```
[ :SENSe ] :MONitor :AVERage :TCONtrol ?
```

Select the type of termination control used for the averaging function. This determines the averaging action after the specified number of data acquisitions (average count) is reached.

Exponential - After the average count is reached, each successive data acquisition is exponentially weighted and combined with the existing average.

Repeat - After reaching the average count, the averaging is reset and a new average is started.

Factory Preset: Exponential

Remarks: You must be in the Bluetooth, cdmaOne, GSM, Modulation Analysis, Noise Figure or Phase Noise mode to use this command. Use INSTRument:SElect to set the mode.

Front Panel

Access: **Meas Setup, Avg Mode**

Monitor Spectrum Or Monitor Band/channel—Resolution Bandwidth

```
[ :SENSe ] :MONitor :BANDwidth | BWIDth [ :RESolution ] <freq>
```

```
[ :SENSe ] :MONitor :BANDwidth | BWIDth [ :RESolution ] ?
```

Enables you to select the 3.01 dB resolution bandwidth (RBW) of the analyzer in steps from 1 Hz to 3 MHz in a 1:3:10 sequence.

If an unavailable bandwidth is specified, the closest available bandwidth is selected.

Sweep time is coupled to RBW. As the RBW changes, the sweep time (if set to **Auto**) is changed to maintain amplitude calibration.

Factory Preset: 1 MHz

Range 1 Hz to 5 MHz

Default Unit: Hz

Front Panel

Access: **BW/Avg**

Monitor Spectrum Or Monitor Band/channel—Resolution Bandwidth Automatic

```
[ :SENSe ] :MONitor :BANDwidth | BWIDth [ :RESolution ] :AUTO
```

Language Reference
SENSe Subsystem

OFF | ON | 0 | 1

[:SENSe] :MONitor :BANDwidth | BWIDth [:RESolution] :AUTO?

Couples the resolution bandwidth to the frequency span.

When set to **Auto**, resolution bandwidth is autocoupled to span. The ratio of span to RBW is set by **Span/RBW**. The factory default for this ratio is approximately 106:1 when auto coupled. When Res BW is set to **Man**, bandwidths are entered by the user, and these bandwidths are used regardless of other analyzer settings.

Factory Preset: ON

Front Panel

Access: **BW/Avg**

Monitor Spectrum Or Monitor Band/channel—Video Bandwidth

[:SENSe] :MONitor :BANDwidth | BWIDth :VIDeo <freq>

[:SENSe] :MONitor :BANDwidth | BWIDth :VIDeo?

Specifies the video bandwidth.

You can change the analyzer post-detection filter from 1 Hz to 5 MHz in a 1:3:10 sequence.

Factory Preset: 3 MHz

Range 1 Hz to 3 MHz

Default Unit: Hz

Front Panel

Access: **BW/Avg**

Monitor Spectrum Or Monitor Band/channel—Video Bandwidth Automatic

[:SENSe] :MONitor :BANDwidth | BWIDth :VIDeo :AUTO OFF | ON | 0 | 1

[:SENSe] :MONitor :BANDwidth | BWIDth :VIDeo :AUTO?

Couples the video bandwidth to the resolution bandwidth, using the VBW/RBW ratio that you have set.

Factory Preset: ON

Front Panel

Access: **BW/Avg**

Monitor Spectrum Or Monitor Band/channel—Video to Resolution Bandwidth Ratio

```
[ :SENSE ] :MONitor: BANDwidth | BWIDth: VIDEo: RATIO <numeric>
```

```
[ :SENSE ] :MONitor: BANDwidth | BWIDth: VIDEo: RATIO?
```

Specifies the ratio of the video bandwidth to the resolution bandwidth. The knob and the step keys change the ratio in a 1, 3, 10 sequence.

Factory Preset: 1.00000

Range: 0.00001 to 10

Front Panel

Access: **BW/Avg**

Monitor Spectrum Or Monitor Band/channel—Type of Detection

```
[ :SENSE ] :MONitor: DETector [ :FUNction ] NORMal  
| POSitive | NEGative | AVERage
```

```
[ :SENSE ] :MONitor: DETector [ :FUNction ] ?
```

Specifies the detection mode.

Normal detection displays the peak of CW-like signals and maximums and minimums of noise-like signals.

Positive peak detection displays the highest sample level measured during each sampling period.

Negative peak detection displays the lowest sample level measured during each sampling period.

Average detection displays the average of the samples taken during each sampling period. The averaging method depends upon AVG Type selection (voltage, power or log scales).

Factory Preset: AVERage

Range: NORM | POS | NEG | AVER

Front Panel

Access: **Det/Demod, Detector**

Monitor Spectrum Or Monitor Band/channel—Center Frequency

```
[ :SENSE ] :MONitor: FREQUENCY [ :CENTer ] <freq>
```

```
[ :SENSE ] :MONitor: FREQUENCY [ :CENTer ] ?
```

Sets the center frequency.

Factory Preset: 1.5 GHz for all except ESA E4401B

Language Reference
SENSe Subsystem

	755 MHz on the ESA E4401B
Range:	ESA E4401B: 0 Hz to 1.5 GHz ESA E4402B: 0 Hz to 3.0 GHz ESA E4404B: 0 Hz to 6.7 GHz ESA E4405B: 0 Hz to 13.2 GHz ESA E4407B: 0 Hz to 26.5 GHz
Remarks:	The center frequency range shifts up or down depending on the Frequency Offset settings.
Default Unit:	Hz
Front Panel Access:	FREQUENCY/Channel, Center Freq

Monitor Spectrum Or Monitor Band/channel—Frequency Offset

[[:SENSe]:MONitor:FREQuency:OFFSet <freq>

[[:SENSe]:MONitor:FREQuency:OFFSet?

Enables you to input a frequency offset value to account for frequency conversions external to the analyzer. This value is added to the display readout of the marker frequency, center frequency, start frequency, stop frequency and all other absolute frequency settings in the analyzer. When a frequency offset is entered, the value appears below the center of the graticule. To eliminate an offset, perform a Factory Preset or set the frequency offset to 0 Hz.

This command does not affect any bandwidths or the settings of relative frequency parameters such as delta markers or span. It does not affect the current hardware settings of the analyzer, but only the displayed frequency values. Offsets are not added to the frequency count readouts. Entering an offset does not affect the trace display.

Factory Preset:	0 Hz
Range:	-325 GHz to +325 GHz
Default Unit:	Hz
Front Panel Access:	FREQUENCY/Channel, Freq Offset

Monitor Spectrum Or Monitor Band/channel—Frequency Offset Auto

[[:SENSe]:MONitor:FREQuency:OFFSet:AUTO ON|OFF|1|0

[[:SENSe]:MONitor:FREQuency:OFFSet:AUTO?

Allows you to specify whether the spectrum analyzer compensates automatically

for a frequency changing device, or whether you wish to set the compensation manually. Setting a value on 'ON' or '1' makes the compensation automatic, and setting to 'OFF' or '0' set the compensation to manual.

NOTE Manually setting the Frequency Offset to 0 Hz is equivalent to disabling the feature.

Factory Preset: On

Front Panel

Access: **FREQUENCY/Channel, Freq Offset**

Monitor Spectrum or Monitor Band/Channel—Frequency Span

[:SENSe] :MONitor :FREQuency :SPAN <freq>

[:SENSe] :MONitor :FREQuency :SPAN?

Set the frequency span. Setting the span to 0 Hz puts the analyzer into zero span.

NOTE The maximum span is limited to 5 MHz whenever the resolution bandwidth is set to a value of less than 1 kHz.

Factory Preset: 2.9900 GHz on all except E4401B
1490 MHz on E4401B

Range: ESA E4401B: 100 Hz to 1.58 GHz
ESA E4402B: 100 Hz to 3.10 GHz
ESA E4404B: 100 Hz to 6.78 GHz
ESA E4405B: 100 Hz to 13.3 GHz
ESA E4407B: 100 Hz to 27.0 GHz

Default Unit: Hz

Front Panel

Access: **SPAN/X Scale, Span**
or **SPAN/X Scale, Zero Span**

Monitor Spectrum or Monitor Band/Channel—Full Frequency Span

[:SENSe]:MONitor:FREQuency:SPAN:FULL

Set the frequency span to full scale.

NOTE The maximum span is limited to 5 MHz whenever the resolution bandwidth is set to a value of less than 1 kHz.

Factory Preset: ESA E4401B: 1.5 GHz
 ESA E4402B: 3.0 GHz
 ESA E4404B: 6.7 GHz
 ESA E4405B: 13.2 GHz
 ESA E4407B: 26.5 GHz

Front Panel
 Access: **SPAN/X Scale, Full Span**

Monitor Spectrum or Monitor Band/Channel—Zero Frequency Span

[:SENSe]:MONitor:FREQuency:SPAN:ZERO

Set the frequency span to zero.

NOTE The maximum span is limited to 5 MHz whenever the resolution bandwidth is set to a value of less than 1 kHz.

Front Panel
 Access: **SPAN/X Scale, Zero Span**

Monitor Spectrum or Monitor Band/Channel—Start Frequency

[:SENSe]:MONitor:FREQuency:START <freq>

[:SENSe]:MONitor:FREQuency:START?

Set the start frequency.

Factory Preset: 10 MHz

Range: ESA E4401B: -80 MHz to 1.58 GHz
 ESA E4402B: -80 MHz to 3.10 GHz
 ESA E4404B: -80 MHz to 6.78 GHz
 ESA E4405B: -80 MHz to 13.3 GHz
 ESA E4407B: -80 MHz to 27.0 GHz

NOTE The valid range of Frequency Start settings (above) applies when Frequency Offset is set to 0 Hz. Frequency Offset settings greater than 0 Hz have the effect of shifting the entire range up by the Frequency Offset.

Default Unit: Hz

Front Panel

Access: **FREQUENCY/Channel, Start Freq**

Monitor Spectrum or Monitor Band/Channel—Stop Frequency

[:SENSe] :MONitor :FREQuency :STOP <freq>

[:SENSe] :MONitor :FREQuency :STOP?

Set the stop frequency.

Factory Preset: E4401B: 1.5 GHz

All other analyzers: 3.0 GHz

Range: ESA E4401B: -79.9999 MHz to 1.58 GHz

ESA E4402B: -79.9999 MHz to 3.10 GHz

ESA E4404B: -79.9999 MHz to 6.78 GHz

ESA E4405B: -79.9999 MHz to 13.3 GHz

ESA E4407B: -79.9999 MHz to 27.0 GHz

NOTE The valid range of Frequency Start settings (above) applies when Frequency Offset is set to 0 Hz. Frequency Offset settings greater than 0 Hz have the effect of shifting the entire range up by the Frequency Offset.

Default Unit: Hz

Front Panel

Access: **FREQUENCY/Channel, Stop Freq**

Monitor Spectrum Or Monitor Band/channel—RF Port Input Attenuation

[:SENSe] :MONitor :POWer [:RF] :ATTenuation <rel_power>

[:SENSe] :MONitor :POWer [:RF] :ATTenuation?

Sets the RF input attenuator. This value is set at its auto value if RF input attenuation is set to auto.

Factory Preset: 5dB

Range: 0 to 65 dB

Default Unit: dB

Front Panel

Access: **AMPLITUDE/Y Scale, Attenuation**

Monitor Spectrum Or Monitor Band/channel—RF Port Input Attenuator Auto

`[:SENSe] :MONitor :POWer [:RF] :ATTenuation :AUTO ON | OFF | 1 | 0`

`[:SENSe] :MONitor :POWer [:RF] :ATTenuation :AUTO ?`

Selects the RF input attenuator range to be set either automatically or manually.

ON - Input attenuation is automatically set as determined by the reference level setting.

OFF - Input attenuation is manually set.

Factory Preset: ON (auto)

Front Panel

Access: **AMPLITUDE/Y Scale, Attenuation**

Monitor Spectrum Or Monitor Band/channel—Internal Preamp

`[:SENSe] :MONitor :POWer [:RF] :GAIN [:STATe] ON | OFF | 1 | 0`

`[:SENSe] :MONitor :POWer [:RF] :GAIN : [:STATe] ?`

Turns the internal preamp on or off. This requires you to have Option 1DS installed.

Factory Preset: ON (if available)

Front Panel

Access: **Meas Setup, Int Preamp**

Monitor Spectrum Or Monitor Band/channel—Optimize Reference Level

`[:SENSe] :MONitor :POWer [:RF] :RANGe :AUTO`

This optimizes the reference level and the attenuator settings for the current signal in the current span. To prevent possible damage to the spectrum analyzer, the values are set with the noise source turned ON.

The Reference Level is set so that the signal is kept as close as possible to the top of the display. Attenuation is set to a level such that the mixer input never exceeds -20 dBm. All attenuation settings are allowed, including 0 dB.

Factory Preset:

Front Panel

Access: **Amplitude, Optimize Ref Level**

Monitor Spectrum or Monitor Band/Channel—Trace Points`[:SENSe] :MONitor :SWEep :POINTs?`

Allows you to query the number of trace points.

Factory Preset: 601

Range: 101 to 8192

Front Panel

Access: **Sweep**

Monitor Spectrum or Monitor Band/Channel—Sweep Time`[:SENSe] :MONitor :SWEep :TIME <value>``[:SENSe] :MONitor :SWEep :TIME?`

Specifies the sweep time of the measurement.

Factory Preset: Automatically calculated

Range: 1 μ s to 2 ksecs in zero span
1 ms to 2 ksecs in swept mode

Front Panel

Access: **Sweep**

Monitor Spectrum or Monitor Band/Channel—Time Mode`[:SENSe] :MONitor :SWEep :TIME :AUTO OFF | ON | 0 | 1``[:SENSe] :MONitor :SWEep :TIME :AUTO?`

Specifies whether the sweep time is set automatically or manually.

Factory Preset: ON (Auto)

Remarks: If set to **AUTO**, the sweep time will be affected by the RBW setting.

Front Panel

Access: **Sweep**

Noise Figure Measurement

Commands for querying the noise figure measurement results and for setting to the default values are found in the MEASure group of commands. The equivalent front panel keys for the parameters described in the following commands are found under the **Meas Setup** key, after the **Noise Figure** measurement has been selected from the **MEASURE** key menu.

Noise Figure—Average Count

```
[ :SENSe ] [ :NFIGure ] :AVERAge:COUNT <integer>
```

```
[ :SENSe ] [ :NFIGure ] :AVERAge:COUNT?
```

Set the number of data acquisitions that will be averaged. After the specified number of average counts, the averaging mode (terminal control) setting determines the averaging action.

Factory Preset: 10

Range: 1 to 1000

Remarks: You must be in the Noise Figure mode to use this command.
Use INSTRument:SElect to set the mode.

Front Panel

Access: **Meas Setup, Avg Number**

Noise Figure—Averaging State

```
[ :SENSe ] [ :NFIGure ] :AVERAge [ :STATe ] OFF | ON | 0 | 1
```

```
[ :SENSe ] [ :NFIGure ] :AVERAge [ :STATe ] ?
```

Turn averaging on or off.

Factory Preset: OFF

Remarks: You must be in the Noise Figure mode to use this command.
Use INSTRument:SElect to set the mode.

Remarks: The SCPI command :CONFigure:NFIGure does not switch averaging ON, but rather sets averaging to the factory default of OFF.

Front Panel

Access: **Meas Setup, Avg Number**

Noise Figure—Averaging Termination Control

```
[ :SENSe ] [ :NFIGure ] :AVERAge:TCONtrol?
```

Queries the type of termination control used for the averaging function. This determines the averaging action after the specified number of data acquisitions

(average count) is reached.

REPeat - After reaching the average count, the averaging is reset and a new average is started.

Factory Preset: REPeat

Range: REPeat only

Remarks: You must be in the Noise Figure mode to use this command. Use INSTRument:SElect to set the mode.

Remarks: It is not possible to perform exponential averaging on noise figure measurements, so repeat averaging is always used.

Front Panel

Access: Front Panel access is disabled (grayed out) as REPeat is the only option.

Noise Figure—Resolution Bandwidth

```
[ :SENSE] [:NFIGure] :BANDwidth | BWIDth [:RESolution] <freq>
```

```
[ :SENSE] [:NFIGure] :BANDwidth | BWIDth [:RESolution] ?
```

Enables you to select the 3.01 dB resolution bandwidth (RBW) of the analyzer from 1 kHz to 5 MHz in a 1:3:10 sequence.

If an unavailable bandwidth is specified, the closest available bandwidth is selected.

Sweep time is coupled to RBW. As the RBW changes, the sweep time (if set to **Auto**) is changed to maintain amplitude calibration.

Factory Preset: 1 MHz

Range: 1 kHz to 5 MHz

Default Unit: Hz

Remarks: You must be in the Noise Figure mode to use this command. Use INSTRument:SElect to set the mode.

Front Panel

Access: **BW/Avg**

Noise Figure—Resolution Bandwidth Automatic

```
[ :SENSe] [ :NFIGure] :BANDwidth|BWIDth[:RESolution]:AUTO  
OFF|ON|0|1
```

```
[ :SENSe] [ :NFIGure] :BANDwidth|BWIDth[:RESolution]:AUTO?
```

Couples the resolution bandwidth to the frequency span.

Table 7-1 RBW Auto Settings

Measurement Frequency	Resolution Bandwidth
Less than 130 kHz	1 kHz
130 kHz or greater, and less than 380 kHz	3 kHz
380 kHz or greater, and less than 980 kHz	10 kHz
980kHz or greater, and less than 2.8 MHz	30 kHz
2.8 MHz or greater, and less than 7.4 MHz	100 kHz
7.4 MHz or greater, and less than 21 MHz	300 kHz
21 MHz or greater	1 MHz

When set to **Auto**, resolution bandwidth is autocoupled to span. The ratio of span to RBW is set by **Span/RBW**. The factory default for this ratio is approximately 106:1 when auto coupled.

When Res BW is set to **Man**, bandwidths are entered by the user, and these bandwidths are used regardless of other analyzer settings.

Factory Preset: ON (Auto)

Range: ON (Auto) | OFF (Manual) | 1 | 0

Remarks: You must be in the Noise Figure mode to use this command.
Use INSTRument:SELEct to set the mode.

[Table 7-2](#) shows the frequencies at which ESA-E Series analyzers must be DC coupled.

Front Panel

Access: **BW/Avg**

Table 7-2 When to use DC Coupling on the ESA Series of Analyzers

Model Number	Switch to DC Coupling Below this Frequency
E4401B	Always AC coupled
E4402B without Option UKB	Always AC Coupled
E4402B with Option UKB	100 kHz
E4404B with or without Option UKB	100 kHz
E4405B with or without Option UKB	100 kHz
E4407B Without Option UKB	Always DC Coupled
E4407B with Option UKB	10 MHz

CAUTION Instrument damage can occur if there is a DC component present at the RF INPUT and DC coupling is selected.

Noise Figure—Calibrate

[:SENSe] [:NFIGure] :CORRection:COLLect [:ACQuire] STANdard

Calibrates your measurement for use with a specific noise source. When issuing this command, the ENR (Excess Noise Ratio) data must already have been entered into the ENR table, or into the Calibration Table if Common Table has been switched off.

NOTE When performing this calibration using the front panel keys, the **Calibrate...** softkey has to be pressed twice. The first time you press the **Calibrate...** softkey, a warning message is displayed asking you to confirm that you want to calibrate the measurement. This safety feature is not present when issuing the remote SCPI command. The SCPI command only needs to be issued once to be effective.

Remarks: You must be in the Noise Figure mode to use this command. Use INSTRUMENT:SELEct to set the mode.

Example: CORR:COLL STAN

Front Panel

Access: **Meas Setup, Calibrate..., Calibrate...**

Noise Figure—Automatically Load the ENR Table

[:SENSe] [:NFIGure] :CORRection:ENR:AUTO [:STATe] ON|OFF|1|0

[:SENSe] [:NFIGure] :CORRection:ENR:AUTO [:STATe] ?

Automatically extracts the Excess Noise Ratio (ENR) data from the Smart Noise Source (SNS) and loads it into the ENR table. If you do not have an SNS connected, the ENR data will be automatically extracted as soon as an SNS is connected.

Factory Preset: On

Range: On|Off|1|0

Remarks: You must be in the Noise Figure mode to use this command.
Use INSTRument:SELEct to set the mode.

Front Panel

Access: **Meas Setup, ENR, SNS Setup**

Noise Figure—Number of Entries in Calibration ENR Table

[:SENSe] [:NFIGure] :CORRection:ENR:CALibration:TABLE:COUNT?

Returns the number of pairs of entries (that is, frequency and amplitude pairs) in the calibration ENR (Excess Noise Ratio) table.

Factory Preset: Not applicable

Range: 1 to 401 frequency/amplitude point pairs.

Remarks: You must be in the Noise Figure mode to use this command.
Use INSTRument:SELEct to set the mode.

Front Panel

Access: **Meas Setup, ENR, Cal Table...**

Noise Figure—Calibration ENR Table Data

**[:SENSe] [:NFIGure] :CORRection:ENR:CALibration:TABLE:DATA
<frequency, <amplitude> [, <frequency>, <amplitude>]**

[:SENSe] [:NFIGure] :CORRection:ENR:CALibration:TABLE:DATA?

Enters data into the current calibration ENR table. Once entered the table can be stored in a file.

It is not possible to specify units with this command and values are taken to be in Hz and dB. The query returns values in Hz and dB.

Factory Preset: Not applicable

Range: 1 to 401 pairs of frequency and amplitude figures.

Remarks: You must be in the Noise Figure mode to use this command.
Use INSTRument:SELEct to set the mode.

Front Panel

Access: **Meas Setup, ENR, Cal Table...****NOTE**

If you are using a Smart Noise Source (SNS), the ENR Table data can be loaded automatically by setting Auto Load to On. See [“Noise Figure—Automatically Load the ENR Table”](#) on page 319.

Noise Figure—Noise Source ID for Calibration ENR Table

```
[ :SENSe] [:NFIGure] :CORRection:ENR:CALibration:TABLE:ID
:DATA <string>
```

```
[ :SENSe] [:NFIGure] :CORRection:ENR:CALibration:TABLE:ID
:DATA?
```

Enters the ID of the noise source associated with the ENR table used for calibration. The ID is stored with the ENR table when saving it to file.

Factory Preset: Not applicable

Range: Quoted string of up to 12 characters (for example, '346B').

Remarks: You must be in the Noise Figure mode to use this command. Use INSTRument:SElect to set the mode.

If you are using a Smart Noise Source (SNS), the Noise Source's ID can be loaded automatically by setting Auto Load to On. See [“Noise Figure—Automatically Load the ENR Table”](#) on page 319.

Front Panel

Access: **Meas Setup, ENR, Cal Table...****Noise Figure—Noise Source Serial Number for Calibration ENR Table**

```
[ :SENSe] [:NFIGure] :CORRection:ENR:CALibration:TABLE:SERial
:DATA <string>
```

```
[ :SENSe] [:NFIGure] :CORRection:ENR:CALibration:TABLE:SERial
:DATA?
```

Enters the serial number of your noise source into the calibration table. This uniquely identifies the specific noise source associated with this calibration data.

Factory Preset: Not applicable

Range: Quoted string of up to 20 characters (for example, '2037A00729').

Remarks: You must be in the Noise Figure mode to use this command. Use INSTRument:SElect to set the mode.

If you are using a Smart Noise Source (SNS), the noise source's

Language Reference
SENSe Subsystem

serial number can be loaded automatically by setting Auto Load to On. See “Noise Figure—Automatically Load the ENR Table” on page 319.

Front Panel

Access: **Meas Setup, ENR, Cal Table...**

Noise Figure—Fill Calibration Table With Data From SNS

[:SENSe] [:NFIGure] :CORRection:ENR:CALibration:TABLE:SNs

Populates the ENR Calibration table with the data extracted from a connected Smart Noise Source (‘SNS’).

The ENR Calibration table is populated automatically if you have SNS Auto Load set to On (See “Noise Figure—Automatically Load the ENR Table” on page 319.) You can use this command to populate the ENR Calibration table when SNS Auto Load is set to Off.

Factory Preset: Not applicable

Range: Not applicable.

Remarks: You must be in the Noise Figure mode to use this command. Use INSTRument:SELEct to set the mode.

Front Panel

Access: **Meas Setup, ENR, Cal Table..., Tab**

Noise Figure—Common ENR Table Control

[:SENSe] [:NFIGure] :CORRection:ENR:COMMON[:STATe] ON|OFF|1|0

[:SENSe] [:NFIGure] :CORRection:ENR:COMMON[:STATe] ?

Enables and disables the common ENR table. When enabled, the measurement ENR table is used for both calibration and measurement. When disabled, calibration uses its own table.

Factory Preset: ON

Range: ON|OFF|1|0

Remarks: You must be in the Noise Figure mode to use this command. Use INSTRument:SELEct to set the mode.

Front Panel

Access: **Meas Setup, ENR, Common Table**

Noise Figure—Number of Entries in Measurement ENR Table

[:SENSe] [:NFIGure] :CORRection:ENR[:MEASurement] :TABLE:COUNT

?

Queries the number of entries in the measurement ENR (Excess Noise Ratio) table.

Factory Preset: Not applicable

Range: 0 to 401 frequency/amplitude point pairs.

Remarks: You must be in the Noise Figure mode to use this command. Use INSTRument:SElect to set the mode.

Front Panel

Access: **Meas Setup, ENR, Meas Table...**

Noise Figure—Noise Source ID for Measurement ENR Table

```
[ :SENSe] [ :NFIGure] :CORRection:ENR [ :MEASurement] :TABLE:ID
:DATA <string>
```

```
[ :SENSe] [ :NFIGure] :CORRection:ENR [ :MEASurement] :TABLE:ID
:DATA?
```

Enters the ID of the noise source associated with the ENR table used for measurement. The ID is stored with the ENR table when saving it to file.

Factory Preset: Not applicable

Range: Quoted string of up to 12 characters (for example, '346B').

Remarks: You must be in the Noise Figure mode to use this command. Use INSTRument:SElect to set the mode.

If you are using a Smart Noise Source (SNS), the noise source's ID can be loaded automatically by setting Auto Load to On. See [“Noise Figure—Automatically Load the ENR Table” on page 319.](#)

Front Panel

Access: **Meas Setup, ENR, Meas Table...**

Noise Figure—Noise Source Serial Number for Measurement ENR Table

```
[ :SENSe] [ :NFIGure] :CORRection:ENR [ :MEASurement] :TABLE
:SERial:DATA <string>
```

```
[ :SENSe] [ :NFIGure] :CORRection:ENR [ :MEASurement] :TABLE
:SERial:DATA?
```

Enters the serial number of the noise source associated with the ENR table used for measurement. The serial number is stored with the ENR table when saving it to file.

Factory Preset: Not applicable

Language Reference
SENSe Subsystem

Range: Quoted string of up to 20 characters (for example, '2037A00729').

Remarks: You must be in the Noise Figure mode to use this command. Use INSTRument:SElect to set the mode.

If you are using a Smart Noise Source (SNS), the noise source's serial number can be loaded automatically by setting Auto Load to On. See [“Noise Figure—Automatically Load the ENR Table” on page 319](#).

Front Panel
Access: **Meas Setup, ENR, Meas Table...**

Noise Figure—Measurement ENR Table Data

```
[ :SENSe] [ :NFIGure] :CORRection:ENR [ :MEASurement] :TABLE:DATA
<frequency, <amplitude>[, <frequency>, <amplitude>]
```

```
[ :SENSe] [ :NFIGure] :CORRection:ENR [ :MEASurement] :TABLE:DATA?
```

Enters data into the current measurement ENR table. Once entered the table can be stored in a file.

It is not possible to specify units with this command and values are taken to be in Hz and dB. The query returns values in Hz and dB.

Factory Preset: Not applicable

Range: 0 to 401 frequency/amplitude point pairs

Remarks: You must be in the Noise Figure mode to use this command. Use INSTRument:SElect to set the mode.

Front Panel
Access: **Meas Setup, ENR, Meas Table...**

NOTE

If you are using a Smart Noise Source (SNS), this ENR Table data can be loaded automatically by setting Auto Load to On. See [“Noise Figure—Automatically Load the ENR Table” on page 319](#).

Noise Figure—Fill Measurement Table With Data From SNS

```
[ :SENSe] [ :NFIGure] :CORRection:ENR:MEASurement] :TABLE: SNS
```

Populates the ENR Measurement table with the data extracted from a connected Smart Noise Source ('SNS').

The ENR Measurement table is populated automatically if you have SNS Auto Load set to On (See [“Noise Figure—Automatically Load the ENR Table” on page 319](#).) You can use this command to populate the ENR Measurement table when SNS Auto Load is set to Off.

Factory Preset: Not applicable
 Range: Not applicable.
 Remarks: You must be in the Noise Figure mode to use this command.
 Use INSTRument:SElect to set the mode.
 Front Panel
 Access: **Meas Setup, ENR, Meas Table..., Tab**

Noise Figure—ENR Mode

[:SENSE] [:NFIGure] :CORRection:ENR:MODE TABLE | SPOT

[:SENSE] [:NFIGure] :CORRection:ENR:MODE?

Selects between table and spot ENR operation.

TABLE – ENR values are taken from the ENR table.

SPOT – A single ENR value is applied at all frequencies.

Factory Preset: TABLE
 Range: TABLE or SPOT
 Remarks: You must be in the Noise Figure mode to use this command.
 Use INSTRument:SElect to set the mode.
 Front Panel
 Access: **Meas Setup, ENR, ENR Mode**

Noise Figure—ENR Spot Value

```
[ :SENSe] [ :NFIGure] :CORRection:ENR:SPOT <value>
```

```
[ :SENSe] [ :NFIGure] :CORRection:ENR:SPOT?
```

Set the ENR value used when spot ENR is enabled.

The ENR data can be entered in units of dB, Kelvin (K), degrees Celsius (CEL) or degrees Fahrenheit (FAR). The default unit is dB.

For T_{hot} values below 290K see the commands in [“Noise Figure—Spot ENR Mode” on page 331](#) and [“Noise Figure—ENR THot Value” on page 326](#).

Factory Preset: 15.2 dB

Default Unit: dB

Range: -7.0 dB to 50 dB

Remarks: You must be in the Noise Figure mode to use this command.
Use INSTRument:SELEct to set the mode.

Front Panel

Access: **Meas Setup, ENR, Spot**

Noise Figure—ENR T_{Hot} Value

```
[ :SENSe] [ :NFIGure] :CORRection:ENR:THOT <value>
```

```
[ :SENSe] [ :NFIGure] :CORRection:ENR:THOT?
```

Set the ENR value used when spot ENR is enabled.

The ENR data can be entered in units of Kelvin (K), degrees Celsius (CEL) or degrees Fahrenheit (FAR). The default unit is Kelvin.

This command would normally be used to enter ENR values below 290K. See the commands under [“Noise Figure—ENR Spot Value” on page 326](#) and [“Noise Figure—ENR Spot Value” on page 326](#).

Factory Preset: 9892.8K (equivalent to the Spot ENR default of 15.2 dB)

Default Unit: K

Range: 0K to 29,650,000K

Remarks: You must be in the Noise Figure mode to use this command.
Use INSTRument:SELEct to set the mode.

Front Panel

Access: **Meas Setup, ENR, Spot T Hot**

Noise Figure—After DUT Loss Compensation Mode

```
[ :SENSe] [:NFIGure] :CORRection:LOSS:AFTer:MODE FIXed|TABLE
[:SENSe] [:NFIGure] :CORRection:LOSS:AFTer:MODE?
```

Sets the mode of operation for the After DUT Loss Compensation.

TABLE – the After DUT Loss Compensation table is used.

FIXed – a single, fixed After DUT Loss Compensation value is used for all frequencies.

Factory Preset: FIXed

Range: FIXed or TABLE

Remarks: You must be in the Noise Figure mode to use this command.
 Use INSTRument:SElect to set the mode.

Front Panel

Access: **Input/Output, Loss Comp, After DUT Table...**

Noise Figure—After DUT Loss Compensation State

```
[ :SENSe] [:NFIGure] :CORRection:LOSS:AFTer[:STATE] ON|OFF|1|0
[:SENSe] [:NFIGure] :CORRection:LOSS:AFTer[:STATE] ?
```

Enables or disables the After DUT Loss Compensation.

Factory Preset: OFF

Range: ON|OFF|1|0

Remarks: You must be in the Noise Figure mode to use this command.
 Use INSTRument:SElect to set the mode.

Front Panel

Access: **Input/Output, Loss Comp, Setup...**

Noise Figure—Number of Entries in After DUT Loss Compensation Table

```
[ :SENSe] [:NFIGure] :CORRection:LOSS:AFTer:TABLE:COUNT?
```

Returns the number of frequency/amplitude pairs of entries in the After DUT Loss Compensation table.

Factory Preset: 0

Range: 0 to 401 frequency/amplitude point pairs

Remarks: You must be in the Noise Figure mode to use this command.
 Use INSTRument:SElect to set the mode.

Front Panel

Access: **Input/Output, Loss Comp, After DUT Table...**

Noise Figure—After DUT Loss Compensation Table Data

```
[ :SENSe] [ :NFIGure] :CORRection:LOSS:AFTer:TABLE:DATA
<frequency>, <amplitude>[, <frequency>, <amplitude>]
```

```
[ :SENSe] [ :NFIGure] :CORRection:LOSS:AFTer:TABLE:DATA?
```

Enters frequency/loss pairs into the After DUT loss table. This can be up to a maximum of 401 pairs.

NOTE

You cannot specify units with this command. Frequencies are assumed to be in Hz and loss values are in dB.

Factory Preset: None

Range: Frequency: 10 Hz to upper frequency limit of your spectrum analyzer

Amplitude: -200 dB to 200dB

Remarks: You must be in the Noise Figure mode to use this command. Use INSTRument:SElect to set the mode.

Front Panel

Access: **Input/Output, Loss Comp, After DUT Table...**

Noise Figure—After DUT Loss Compensation Fixed Value

```
[ :SENSe] [ :NFIGure] :CORRection:LOSS:AFTer:VALue <value>
```

```
[ :SENSe] [ :NFIGure] :CORRection:LOSS:AFTer:VALue?
```

Specifies the single After DUT Loss Compensation value that is applied at all frequencies. You cannot specify units with this command. All loss values are given in dB.

NOTE

This compensation loss value will only be applied if the Compensation After DUT State is set to **On**, and if the Compensation After DUT is set to **Fixed**.

Factory Preset: 0 dB

Range: -100 dB to +100 dB

Remarks: You must be in the Noise Figure mode to use this command. Use INSTRument:SElect to set the mode.

Front Panel

Access: **Input/Output, Loss Comp, Setup..., Fixed**

Noise Figure—Before DUT Loss Compensation Mode

```
[ :SENSE] [ :NFIGure] :CORRection:LOSS:BEFOre:MODE FIXed|TABLE
[ :SENSe] [ :NFIGure] :CORRection:LOSS:BEFOre:MODE?
```

Sets the mode of operation for the Before DUT Loss Compensation.

TABLE – the Before DUT Loss Compensation table is used.

FIXed – a single, fixed Before DUT Loss Compensation value is used for all frequencies.

Factory Preset: FIXed
 Range: FIXed or TABLE
 Remarks: You must be in the Noise Figure mode to use this command.
 Use INSTRument:SElect to set the mode.

Front Panel
 Access: **Input/Output, Loss Comp, Before DUT Table...**

Noise Figure—Before DUT Loss Compensation State

```
[ :SENSE] [ :NFIGure] :CORRection:LOSS:BEFOre [ :STATE]
ON|OFF|1|0
[ :SENSe] [ :NFIGure] :CORRection:LOSS:BEFOre [ :STATE] ?
```

Enables or disables the Before DUT Loss Compensation.

Factory Preset: OFF
 Range: ON|OFF|1|0
 Remarks: You must be in the Noise Figure mode to use this command.
 Use INSTRument:SElect to set the mode.

Front Panel
 Access: **Input/Output, Loss Comp, Setup...**

Noise Figure—Number of Entries in Before DUT Loss Compensation Table

```
[ :SENSE] [ :NFIGure] :CORRection:LOSS:BEFOre:TABLE:COUNT?
```

Returns the number of frequency/amplitude pairs of entries in the Before DUT Loss Compensation table.

Factory Preset: 0
 Range: 0 to 401 frequency/amplitude point pairs
 Remarks: You must be in the Noise Figure mode to use this command.
 Use INSTRument:SElect to set the mode.

Language Reference
SENSe Subsystem

Front Panel
Access: **Input/Output, Loss Comp, Before DUT Table...**

Noise Figure—Before DUT Loss Compensation Table Data

`[:SENSe] [:NFIGure] :CORRection:LOSS:BEFore:TABLE:DATA
<frequency>, <amplitude>[, <frequency>, <amplitude>]`

`[:SENSe] [:NFIGure] :CORRection:LOSS:BEFore:TABLE:DATA?`

Enters frequency/loss pairs into the Before DUT loss table. This can be up to a maximum of 401 pairs.

NOTE You cannot specify units with this command. Frequencies are assumed to be in Hz and loss values are in dB.

Factory Preset: None

Range: Frequency: 10 Hz to upper frequency limit of your spectrum analyzer
Amplitude: -200 dB to 200dB

Remarks: You must be in the Noise Figure mode to use this command.
Use INSTRument:SELEct to set the mode.

Front Panel
Access: **Input/Output, Loss Comp, Before DUT Table...**

Noise Figure—Before DUT Loss Compensation Fixed Value

`[:SENSe] [:NFIGure] :CORRection:LOSS:BEFore:VALue <value>`

`[:SENSe] [:NFIGure] :CORRection:LOSS:BEFore:VALue?`

Specifies the single Before DUT Loss Compensation value that is applied at all frequencies. You cannot specify units with this command. All loss values are given in dB.

NOTE This compensation loss value will only be applied if the Compensation Before DUT State is set to **On**, and if the Compensation Before DUT is set to **Fixed**.

Factory Preset: 0 dB

Range: -100 dB to +100 dB

Remarks: You must be in the Noise Figure mode to use this command.
Use INSTRument:SELEct to set the mode.

Front Panel
Access: **Input/Output, Loss Comp, Setup..., Fixed**

Noise Figure—Spot ENR Mode

```
[ :SENSe] [:NFIGure] :CORRection:SPOT:MODE ENR | THOT
[ :SENSe] [:NFIGure] :CORRection:SPOT:MODE?
```

The command “Noise Figure—ENR Spot Value” on page 326 cannot be used to enter values below 290K. The command “Noise Figure—ENR THot Value” on page 326 can enter temperature values below 290K. This command selects which value is used in making measurements.

Factory Preset: ENR
 Range: ENR or THOT
 Remarks: You must be in the Noise Figure mode to use this command.
 Use INSTRument:SElect to set the mode.

Front Panel
 Access: **Meas Setup, ENR, Spot, Spot State**

Noise Figure—SNS T_{cold} Control

```
[ :SENSe] [:NFIGure] :CORRection:TCOLd:SNS [:STATE] ON | OFF | 1 | 0
[ :SENSe] [:NFIGure] :CORRection:TCOLd:SNS [:STATE] ?
```

Determines whether or not the T_{cold} temperature is taken from a Smart Noise Source (SNS).

When set to **On** with an SNS attached, the T_{Cold} value is read directly from the SNS. When set to **Off**, or when set to **On** but with no SNS attached, the T_{Cold} value is either the default value, or it is taken from your User Defined T_{Cold} setting. This is determined by your T_{Cold} Mode setting (See “Noise Figure—User T_{cold} Control” on page 332.)

Factory Preset: Off
 Range: ON | OFF | 1 | 0
 Remarks: You must be in the Noise Figure mode to use this command.
 Use INSTRument:SElect to set the mode.

Front Panel
 Access: **Meas Setup, ENR, T cold**

Noise Figure—User T_{cold} Taken From an SNS

```
[ :SENSe] [:NFIGure] :CORRection:TCOLd:SET
```

Takes a temperature reading from a Smart Noise Source (SNS). When this

Language Reference
SENSe Subsystem

command is used, it simultaneously sets the User T_{cold} Mode to **User** and the SNS Tcold State to **Off**.

Factory Preset: Not applicable

Remarks: You must be in the Noise Figure mode to use this command.
Use INSTRument:SElect to set the mode.

Front Panel

Access: **Meas Setup, ENR, T cold**

Noise Figure—User T_{cold} Control

`[:SENSe] [:NFIGure] :CORRection:TCOLd:USER[:STATe] ON|OFF|1|0`

`[:SENSe] [:NFIGure] :CORRection:TCOLd:USER[:STATe] ?`

Turns manual control of the T_{Cold} value **On** or **Off**. When set to Off, the default value of 296.5 K is used.

Factory Preset: Off

Range: ON|OFF|1|0

Remarks: You must be in the Noise Figure mode to use this command.
Use INSTRument:SElect to set the mode.

This command is invalid when SNS T_{cold} is **On** and an SNS is attached. See “Noise Figure—SNS Tcold Control” on page 331.

Front Panel

Access: **Meas Setup, ENR, T cold**

Noise Figure—User T_{cold} Value

`[:SENSe] [:NFIGure] :CORRection:TCOLd:USER:VALue
<temperature>`

`[:SENSe] [:NFIGure] :CORRection:TCOLd:USER:VALue?`

Sets the Tcold value in units of Kelvin (K), degrees Celsius (CEL) or degrees Fahrenheit (FAR). This is the applied value when User Tcold is enabled.

Factory Preset: 296.5 K

Range: 0 K to 29,650,000 K

Remarks: You must be in the Noise Figure mode to use this command.
Use INSTRument:SElect to set the mode.

This command is invalid when SNS T_{cold} is **On** and an SNS is attached. See “Noise Figure—SNS Tcold Control” on page 331.

Front Panel
Access: **Meas Setup, ENR, T cold**

Noise Figure—Correction After DUT Temperature

```
[ :SENSe] [ :NFIGure] :CORRection:TEMPerature:AFTer  
<temperature>
```

```
[ :SENSe] [ :NFIGure] :CORRection:TEMPerature:AFTer?
```

Sets the after DUT temperature in units of Kelvin (K), degrees Celsius (CEL) or degrees Fahrenheit (FAR).

Factory Preset: 0 K
Range: 0 K to 29,650,000 K
Remarks: You must be in the Noise Figure mode to use this command.
Use INSTRument:SElect to set the mode.

Front Panel
Access: **Meas Setup, ENR, T cold**

Noise Figure—Correction Before DUT Temperature

```
[ :SENSe] [ :NFIGure] :CORRection:TEMPerature:BEFore  
<temperature>
```

```
[ :SENSe] [ :NFIGure] :CORRection:TEMPerature:BEFore?
```

Sets the before DUT temperature in units of Kelvin (K), degrees Celsius (CEL) or degrees Fahrenheit (FAR).

Factory Preset: 0 K
Range: 0 K to 29,650,000 K
Remarks: You must be in the Noise Figure mode to use this command.
Use INSTRument:SElect to set the mode.

Front Panel
Access: **Meas Setup, ENR, T cold**

Noise Figure—Detector

```
[ :SENSe] [ :NFIGure] :DETEctor [ :FUNction] AVERAge
```

```
[ :SENSe] [ :NFIGure] :DETEctor [ :FUNction] ?
```

Sets and returns the current Detector mode settings.

NOTE AVERAge is the only valid setting for this command.

Language Reference
SENSe Subsystem

Factory Preset: AVERage
 Range: AVERage
 Remarks: You must be in the Noise Figure mode to use this command.
 Use INSTRument:SElect to set the mode.

Front Panel
 Access: **Det/Demod**

Noise Figure—Center Frequency Value

[:SENSe] [:NFIGure] :FREQuency:CENTer <frequency>

[:SENSe] [:NFIGure] :FREQuency:CENTer?

Sets the center frequency when Frequency Mode is set to Sweep.

The frequency can be entered in units of Hz, kHz, MHz or GHz. The query always returns the value in Hz.

Factory Preset: E4401B only: 755 MHz
 All other analyzers: 1.505 GHz

Range: 10 kHz to 325 GHz

Remarks: You will need to use a frequency downconverter to reach the spectrum analyzer's maximum center frequency of 325 GHz. Without a frequency downconverter, your center frequency will be limited to the analyzer's own minimum and maximum. This is dependent on the model number, as shown below.

ESA E4401B: 10 kHz to 1.5 GHz

ESA E4402B: 10 kHz to 3.0 GHz

ESA E4404B: 10 kHz to 6.7 GHz

ESA E4405B: 10 kHz to 13.2 GHz

ESA E4407B: 10 kHz to 26.5 GHz

Remarks: You must be in the Noise Figure mode to use this command.
 Use INSTRument:SElect to set the mode.

Front Panel
 Access: **Frequency/Channel**

Noise Figure—Fixed Frequency Value

[:SENSe] [:NFIGure] :FREQuency:FIXed <frequency>

[:SENSe] [:NFIGure] :FREQuency:FIXed?

Sets the frequency used when fixed frequency mode is enabled.

The frequency can be entered in units of Hz, kHz, MHz or GHz. The query always returns the value in Hz.

Factory Preset: E4401B only: 755 MHz

All other analyzers: 1.505 GHz

Range: 0 Hz to 325 GHz

Remarks: You will need to use a frequency downconverter to reach the spectrum analyzer's maximum fixed frequency of 325 GHz. Without a frequency downconverter, your maximum fixed frequency will be limited to the analyzer's own maximum. This is dependent on the model number, as shown below.

ESA E4401B: 0 Hz to 1.5 GHz

ESA E4402B: 0 Hz to 3.0 GHz

ESA E4404B: 0 Hz to 6.7 GHz

ESA E4405B: 0 Hz to 13.2 GHz

ESA E4407B: 0 Hz to 26.5 GHz

Remarks: You must be in the Noise Figure mode to use this command. Use INSTRument:SElect to set the mode.

Front Panel

Access: **Frequency/Channel**

Noise Figure—Frequency List Data

```
[ :SENSe] [ :NFIGure] :FREQuency:LIST:DATA
<frequency> [, <frequency>]
```

```
[ :SENSe] [ :NFIGure] :FREQuency:LIST:DATA?
```

Enters frequency values into the frequency table. These values represent the frequencies at which the noise figure will be measured. The frequency table can hold up to 401 values. Once loaded, the table can be stored in a file.

You cannot specify units with this command and values are assumed to be Hz. The query returns values in Hz.

Factory Preset: Not applicable

Range: 1 to 401 frequencies (in Hz)

Remarks: You must be in the Noise Figure mode to use this command. Use INSTRument:SElect to set the mode, and your Frequency Mode must be set to **List**.

Front Panel

Access: **Frequency/Channel**

Noise Figure—Number of Entries in the Frequency List

```
[ :SENSe] [ :NFIGure] :FREQuency:LIST:COUNT?
```

Returns an integer representing the number of frequency values in the frequency table.

Factory Preset: Not applicable

Range: 1 to 401

Remarks: You must be in the Noise Figure mode to use this command.
Use INSTRument:SELEct to set the mode.

Front Panel

Access: **Frequency/Channel, Freq List**

Noise Figure—Frequency Mode

```
[ :SENSe] [ :NFIGure] :FREQuency:MODE SWEep | FIXed | LIST
```

```
[ :SENSe] [ :NFIGure] :FREQuency:MODE SWEep?
```

Selects the method by which measurement frequencies are generated.

- SWEep - frequency values are generated from the start frequency, the stop frequency, and the number of points parameters
- FIXed - the fixed frequency value is used
- LIST - frequencies are taken from a User defined frequency list

Factory Preset: SWEep

Range: SWEep, FIXed or LIST

Remarks: You must be in the Noise Figure mode to use this command.
Use INSTRument:SELEct to set the mode.

Front Panel

Access: **Frequency/Channel**

Noise Figure—Frequency Span

```
[ :SENSe] [ :NFIGure] :FREQuency:SPAN <span>
```

```
[ :SENSe] [ :NFIGure] :FREQuency:SPAN?
```

Selects the frequency span.

The frequency can be entered in units of Hz, kHz, MHz or GHz. The query always returns the value in Hz.

Factory Preset: 2.990000 GHz

E4401: 1.4900 GHz

Range: 100 Hz to 325 GHz

Remarks: You must be in the Noise Figure mode to use this command.
Use INSTRUMENT:SElect to set the mode.

Front Panel
Access: **Span/X Scale**

Noise Figure—Start Frequency Value

[:SENSE] [:NFIGURE] :FREQUENCY:START <start frequency>

[:SENSE] [:NFIGURE] :FREQUENCY:START?

Selects the start frequency that is used when the Frequency Mode has been set to SWEep, or when you are using the Fill... option in the Frequency List Form.

The frequency can be entered in units of Hz, kHz, MHz or GHz. The query always returns the value in Hz.

Factory Preset: 10 MHz

Range: 10 kHz to (325 GHz minus the minimum span setting)

Remarks: You must be in the Noise Figure mode to use this command.
Use INSTRUMENT:SElect to set the mode.

Front Panel
Access: **Frequency/Channel**

Noise Figure—Stop Frequency Value

[:SENSE] [:NFIGURE] :FREQUENCY:STOP <stop frequency>

[:SENSE] [:NFIGURE] :FREQUENCY:STOP?

Selects the stop frequency that is used when the Frequency Mode has been set to SWEep, or when you are using the Fill... option in the Frequency List Form.

The frequency can be entered in units of Hz, kHz, MHz or GHz. The query always returns the value in Hz.

Factory Preset: E4401B only: 1.5 GHz
All other analyzers: 3 GHz

Range: (10 Hz plus the minimum span setting) to 325 GHz

Remarks: You must be in the Noise Figure mode to use this command.
Use INSTRUMENT:SElect to set the mode.

Front Panel
Access: **Frequency/Channel**

Noise Figure—Internal Preamp Control

```
[ :SENSe ] [ :NFIGure ] :POWer [ :RF ] :GAIN [ :STATe ] ON | OFF | 1 | 0
[ :SENSe ] [ :NFIGure ] :POWer [ :RF ] :GAIN [ :STATe ] ?
```

Turns the internal preamp On or Off. Using your internal preamp (if available) dramatically improves the noise figure over the 100 kHz to 3 GHz frequency range. If you are measuring within this 100 kHz to 3 GHz range, you should always have the internal preamp switched On unless you are using an external preamp.

Factory Preset: ON (if available)

Range: ON or OFF, 1 or 0

Remarks: You must be in the Noise Figure mode to use this command.
Use INSTRument:SELEct to set the mode.

Front Panel

Access: **Meas Setup**

Noise Figure—Number of Points in a Sweep

```
[ :SENSe ] [ :NFIGure ] :SWEep:POINts <integer>
[ :SENSe ] :SWEep:POINts?
```

Sets the number of points in a sweep.

Factory Preset: 11

Range: 2 to 401

Default Unit: Points

Remarks: You must be in the Noise Figure mode to use this command.
Use INSTRument:SELEct to set the mode.

Front Panel

Access: **Frequency**

Noise Figure—Microwave Attenuation

```
[ :SENSe ] [ :NFIGure ] :MANual:MWAVE:FIXed <attenuation>
[ :SENSe ] [ :NFIGure ] :MANual:MWAVE:FIXed?
```

Sets the attenuation to be used. The attenuation can be set in 5 dB steps on the ESA-E series.

Factory Preset: 0 dB

Range: 0 dB to 40 dB, but within the minimum and maximum attenuation range.

Default Unit: dB

Remarks: You must be in the Noise Figure mode to use this command.
Use INSTRUMENT:SElect to set the mode.

Front Panel
Access: **Input/Output**

NOTE

This command has the same effect as

:INPut [:NFIGure]:ATTenuation:VALue <power>. See “RF Attenuation Setting” on page 271.

Noise Figure—RF Attenuation

```
[ :SENSe ] [ :NFIGure ] :MANual:RF:FIXed <attenuation>
```

```
[ :SENSe ] [ :NFIGure ] :MANual:RF:FIXed?
```

Sets the attenuation to be used. The attenuation can be set in 5 dB steps on the ESA-E series.

Factory Preset: 0 dB

Range: 0 dB to 40 dB, but within the minimum and maximum attenuation range.

Default Unit: dB

Remarks: You must be in the Noise Figure mode to use this command. Use INSTRument:SElect to set the mode.

Front Panel

Access: **Input/Output**

NOTE

This command has the same effect as

```
:INPut [ :NFIGure ] :ATTenuation:VALue <power>. See “RF Attenuation Setting” on page 271.
```

RF Power Commands**Optimize Preselector Frequency**

```
[ :SENSe ] :POWer [ :RF ] :PADJust <freq>
```

```
[ :SENSe ] :POWer [ :RF ] :PADJust?
```

This command allows user-defined adjustment of the preselector frequency to optimize its response on the signal of interest.

Factory Preset: 0 Hz

Range: –250 MHz to 250 MHz

Default Unit: None. Use the MHz terminator in order for this command to work.

Remarks: This command is available only on Agilent ESA models E4404B, E4405B, E4407B, and E4408B.

Front Panel

Access: Input/Output, Presel Adjust

SOURce Subsystem

The SOURce subsystem controls the signal characteristics of the source, which is the tracking generator.

Noise Source State

:SOURce:MONitor:NOISe[:STATe] ON|OFF|1|0

:SOURce:MONitor:NOISe[:STATe] ?

Allows you to turn the noise source On and Off manually.

Factory Preset: Off

Range: Off|On

Front Panel

Access: **Source**

SNS Attached?

:SOURce:NOISe:SNS:ATTached?

Queries the analyzer to see whether or not an SNS is attached. The command returns a '1' if an SNS noise source is present, and a '0' if no SNS is present.

Factory Preset: This is a query command only

Range: 1|0

Remarks: This command is available on *ESA-E series analyzers only*.

This command does not consider the current setting of Noise Source Preference (See “Noise Source Preference” on page 341.)

Front Panel

Access: **No front panel access**

Noise Source Preference

:SOURce[:NFIGure]:NOISe[:PREference] NORMal|SNS

:SOURce[:NFIGure]:NOISe[:PREference] ?

Sets the noise source to be either a NORMal type, or a Smart Noise Source (SNS).

Factory Preset: SNS if an SNS is attached, otherwise NORMal

Range: NORMal|SNS

Language Reference
SOURce Subsystem

Remarks: If you have set your preference to SNS but there is no SNS connected to the analyzer, the analyzer reverts to controlling a normal noise source.

Front Panel

Access: **Meas Setup, ENR, SNS Setup**

TRACe Subsystem

TRACe subsystem controls access to the instruments internal trace memory.

NOTE

Refer also to :CALCulate and :MMEMory subsystems for more trace and limit line commands.

Query Trace Maximum Amplitude

```
:TRACe[:NFIGure][[:DATA]:CORRECTed|:UNCORRECTed]:AMPLitude  
:MAXimum? <trace>
```

Returns the maximum amplitude of the given trace and the frequency at which it occurs. The returned values are comma separated and the amplitude value precedes the frequency.

When corrected results are requested, <trace> can be one of:

- GAIN, returning results in dB
- NFACTor, returning linear results
- NFIGure, returning results in dB
- PCOLd, returning results in dB
- PHOT, returning results in dB
- TEFfective, returning results in degrees K

When uncorrected results are requested, <trace> can be one of:

- NFACTor, returning linear results
- NFIGure, returning results in dB
- PCOLd, returning results in dB
- PHOT, returning results in dB
- TEFfective, returning results in degrees K
- YFACor, returning results in dB

You must be in Noise Figure mode to use this command.

Front Panel

Access: **Not available**

Query Trace Minimum Amplitude

```
:TRACe [:NFIGure] [:DATA] :CORReCted | :UNCORReCted:AMPLitude:MI  
Nimum? <trace>
```

Returns the minimum amplitude of the given trace and the frequency at which it occurs. The returned values are comma separated and the amplitude value precedes the frequency.

When corrected results are requested, <trace> can be one of:

- GAIN, returning results in dB
- NFACTor, returning linear results
- NFIGure, returning results in dB
- PCOLd, returning results in dB
- PHOT, returning results in dB
- TEFFective, returning results in degrees K

When uncorrected results are requested, <trace> can be one of:

- NFACTor, returning linear results
- NFIGure, returning results in dB
- PCOLd, returning results in dB
- PHOT, returning results in dB
- TEFFective, returning results in degrees K
- YFACor, returning results in dB

You must be in Noise Figure mode to use this command.

Front Panel

Access: **Not available**

Query Trace Amplitude

```
:TRACe [:NFIGure] [:DATA] :CORReCted | :UNCORReCted:AMPLitude  
[:VALue]? <trace>,<freq>
```

Returns the amplitude value of the given trace at the specified frequency.

When corrected results are requested, <trace> can be one of:

- GAIN, returning results in dB
- NFACTor, returning linear results
- NFIGure, returning results in dB
- PCOLd, returning results in dB
- PHOT, returning results in dB

- TEFFective, returning results in degrees K

When uncorrected results are requested, <trace> can be one of:

- NFACTor, returning linear results
- NFIGure, returning results in dB
- PCOLd, returning results in dB
- PHOT, returning results in dB
- TEFFective, returning results in degrees K
- YFACor, returning results in dB

You must be in Noise Figure mode to use this command.

Front Panel

Access: **Not available**

Query Trace Delta

```
:TRACe[:NFIGure] [:DATA] :CORRECTed | :UNCORRECTed:DELTA?  
<trace>,<freq1>,<freq2>
```

Returns the value obtained by subtracting the amplitude at frequency1 from that at frequency2.

When corrected results are requested, <trace> can be one of:

- GAIN, returning results in dB
- NFACTor, returning linear results
- NFIGure, returning results in dB
- PCOLd, returning results in dB
- PHOT, returning results in dB
- TEFFective, returning results in degrees K

When uncorrected results are requested, <trace> can be one of:

- NFACTor, returning linear results
- NFIGure, returning results in dB
- PCOLd, returning results in dB
- PHOT, returning results in dB
- TEFFective, returning results in degrees K
- YFACor, returning results in dB

You must be in Noise Figure mode to use this command.

Front Panel

Access: **Not available**

Query Trace Peak to Peak

```
:TRACe [:NFIGure] [:DATA] :CORReCted | :UNCORReCted:PTPeak?  
<trace>
```

Returns the difference between the maximum and minimum amplitude values on the given trace and the frequency difference between the two frequency points where the maximum and minimum occur. The returned values are comma separated and the amplitude value precedes the frequency.

When corrected results are requested, <trace> can be one of:

- GAIN, returning results in dB
- NFACTor, returning linear results
- NFIGure, returning results in dB
- PCOLd, returning results in dB
- PHOT, returning results in dB
- TEFFective, returning results in degrees K

When uncorrected results are requested, <trace> can be one of:

- NFACTor, returning linear results
- NFIGure, returning results in dB
- PCOLd, returning results in dB
- PHOT, returning results in dB
- TEFFective, returning results in degrees K
- YFACTor, returning results in dB

You must be in Noise Figure mode to use this command.

Front Panel

Access: **Not available**

8 Troubleshooting Guide

Common Problems and their Resolution

Below is a list of some of the more common problems associated with making noise figure measurements, and hints on their resolution.

- **The ENR Table on my ESA does not get filled from the SNS Noise Source**

If you are having difficulty loading the SNS's ENR data into your analyzer's table, check first of all that all your cables are in good condition and connected securely.

Press the **Meas Setup** hardkey. On the softkey menu, press **ENR** and **SNS Setup**. Confirm that **Preference** is set to **SNS**, and that **Auto Load ENR** is set to **On**.

If you have performed all the checks above and the ENR data will still not load from the SNS, it is likely that the SNS's internal data has become corrupted. You will have to return the SNS to Agilent Technologies for recalibration.

- **The T_{cold} Temperature on my ESA does not get updated from the SNS Noise Source**

If you are having difficulty loading the SNS's T_{cold} data into your analyzer, check first of all that all your cables are in good condition and connected securely.

Press the **Meas Setup** hardkey. The T_{cold} temperature is displayed at the bottom right of the display. If the T_{cold} temperature is followed by the characters '(SNS)', this indicates that the temperature is being read from the SNS. If you cannot see the characters '(SNS)', this confirms that the T_{cold} temperature is not being updated from the SNS. Press **ENR** and **SNS Setup**, and confirm that **Preference** is set to **SNS** and that **Auto Load ENR** is **On**. Press **Meas Setup** again, then **ENR** and **Tcold**, and confirm that **SNS T cold** is **On**, and that **T cold** is set to **User**.

If you have performed all the checks above and T_{cold} temperature is still not being updated from the SNS, it is likely that the SNS's internal data has become corrupted. You will have to return the SNS to Agilent Technologies for recalibration.

- **Results are wrong at low frequencies**

The AC/DC coupling needs to be set to DC Coupling below certain frequencies. The table below shows the frequency below which you

should switch to DC coupling for each model of ESA analyzer.

Table 8-1 When to use DC Coupling on the ESA Series of Analyzers

Model Number	Switch to DC Coupling Below this Frequency
E4401B	Always AC coupled
E4402B without Option UKB	Always AC Coupled
E4402B with Option UKB	100 kHz
E4404B with or without Option UKB	100 kHz
E4405B with or without Option UKB	100 kHz
E4407B Without Option UKB	Always DC Coupled
E4407B with Option UKB	10 MHz

CAUTION

When changing to DC Coupling, make sure there is no DC component being fed into the analyzer’s input port as this could seriously damage the hardware.

- **Spurs in the Frequency Band you are Measuring**

If there are any spurs in the frequency band that you are measuring, these can affect the measurement. Signals as low as -60 dBm can affect your noise figure measurement. Use the Monitor Spectrum measurement with **Preamp** switched **On** and **Attenuation** set to **0 dB** to look for spurs. The Agilent Technologies application note *57-2 Noise Figure Measurement Accuracy - the Y-Factor Method* has more information in the *Preventing Interfering Signals* section. This application note is available from the Agilent website at <http://www.agilent.com>.

- **DSB Measurement on a Downconverter - Measurement are too Low**

If you are making a DSB measurement on a downconverting DUT, you must enter a **Loss Compensation** of **-3 dB** at a **Temperature** of **290 K**. This is because both double sidebands fold down to the same IF frequency, thus doubling the measured power.

NOTE

This does not apply if you are using the System Downconverter because both sidebands are present in the calibration and in the measurement.

- **Does the LO Signal Contain Broadband Noise at the IF?**

When testing Frequency Converters, make sure that the LO signal does not contain broadband noise at the IF frequency. To eliminate broadband noise at the LO, insert a high-pass filter on the LO port

when measuring a downconverter. When measuring an upconverter, insert a low-pass filter on the LO port. These filters must pass signals at the LO frequency, but not at the IF frequency.

- **My Results are too High or too Low**

When you are using **Loss Compensation**, it is important to set the correct DUT temperature. Setting the Temperature to 290 K will compensate for the noise as well as the gain. Leaving the DUT Temperature at 0 K will result in only the gain being compensated.

- **What Sort of Tolerances Should I Expect in my Measurement?**

If you are not sure what level of tolerance to expect in your results, you can use the **Uncertainty Calculator** (See “[Noise Figure Uncertainty Calculator](#)” on page 106.) to calculate the expected result tolerances. This will give you a guide to your expected measurement accuracy.

- **The Measurement Accuracy is not what I Expected**

For maximum accuracy, it is advisable not to attempt to measure noise figures greater than 10 dB above the relevant ENR value of the noise source.

- **Is the DUT Overdriving the Analyzer?**

Check that the DUT is not overdriving the analyzer.

To check for overdriving of the analyzer, that is, compression occurring at the preamp stage, set the attenuation to 0 dB and note the noise figure of your DUT. Now increase the attenuation by one step (5 dB) by pressing the up-arrow key. If your noise figure changes by more than 0.5 dB, attenuation is required. Repeat this process until you have found the lowest level of attenuation that gives you a stable noise figure result, and use this attenuation level for your measurements.

When using external pre-amps or high-gain DUTs, ensure that neither the external pre-amp (or the high-gain DUT) nor the internal pre-amp go into compression as this will affect the accuracy of your measurements. If you suspect that one or other of the pre-amps is going into compression, use attenuation prior to that pre-amp to prevent compression. Note that the analyzer’s internal attenuator will only affect compression occurring in the internal pre-amp. It will not have any effect on any compression occurring in the external pre-amp.

- **Measurements are Taking too Long**

If your measurements are taking too long, you can reduce the time taken by switching **Averaging** to **Off**, by increasing the **Resolution Bandwidth**, and by reducing the **Number of Points** on a swept measurement.

- **Calibration is Taking too Long**

If you find that your calibration is taking too long, you can reduce the calibration time by reducing the frequency span or the attenuation range. This reduces the number of frequency points at which the analyzer is calibrated. Either increase the minimum frequency in the calibration range, or decrease the maximum frequency.

- **Calibration Data > 3 GHz is not what I Expected**

Measurement performance > 3 GHz is not specified. If you do not have a preamp and you are calibrating above 3 GHz, the calibration data will vary significantly. Measurements made with this calibration data might be valid, but only if the device you are testing has a high enough gain and noise figure, such that the sum of these is about 35 dB or more. The measurement accuracy will be poor.

Problems Measuring Above 3 GHz

A preamp is needed for measurements > 3 GHz. While it is possible to make valid measurements without a preamp, measurement accuracy is usually poor. The following curves describe the ESA noise figure measurement error for DUTs with various gains and noise figures.

Figure 8-1 Computed Measurement NF Uncertainty vs. DUT Gain, Non-warranted Frequency Range

ESA Frequency Range: >3 GHz (Non-Warranted)
Assumptions: Measurement Frequency 12 GHz, Instrument NF = 28.7 dB, Instrument VSWR = 1.58, Instrument Gain Uncertainty = 2.7 dB, Instrument NF Uncertainty = 0.41 dB, Agilent 346B Source with Uncertainty = 0.2 dB, Source VSWR = 1.25, DUT input/output VSWR = 1.5

Curves for Positive Error Ranges for DUT NFs of 5, 10, and 15 dB

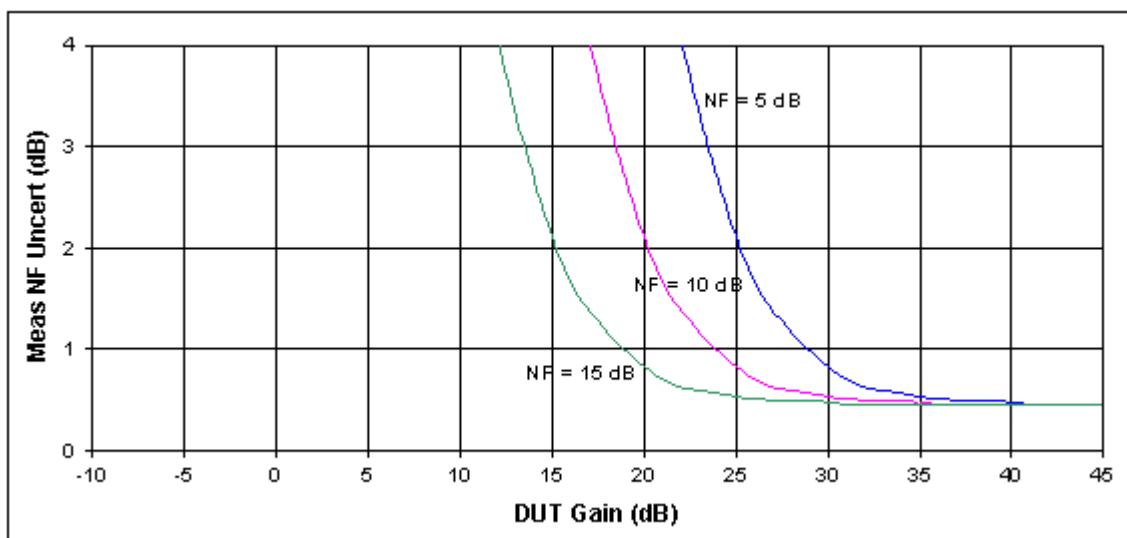

- To use these curves you must be able to estimate the NF and Gain performance of the device that you want to test. Use these values to estimate the amount of measurement error.
- For Example, if your DUT has NF = ~7.5 dB and gain = 20 dB. Plotting these values on the curves will give you an estimated error larger than ± 3.5 dB. This amount of measurement uncertainty is probably too large for the your measurement needs.
- Now add a preamp to the measurement system. Assume this external preamp has NF = 6 dB and gain = 23 dB.
- Assume that the measurement is being made at 12 GHz where the

ESA NF = 28.7 dB. Then the combined NF of the preamp + ESA is ~9 dB. The following curves describe the noise figure measurement error for various DUTs, when the preamp is being used with the spectrum analyzer

Note that the Friss equation can be used to figure out what level of preamp performance is needed for the desired ESA frequency range. See also [Figure 8-2](#) below for nominal ESA noise figure values.

Figure 8-2 Computed Measurement NF Uncertainty vs. DUT Gain, Non-warranted Frequency Range

ESA Frequency Range: >3 GHz (Non-Warranted)

Assumptions: Same as above, with the addition of an external pre-amp. Agilent 346A Source used, which changed instrument noise figure uncertainty to 0.24 dB. With that external pre-amp, the pre-amp/analyzer combination NF is 8.86 dB; the external pre-amp alone has a gain of 23 dB and an NF of 6 dB. Instrument VSWR is now that of the external pre-amp with VSWR = 2.6

Curves for Positive Error Ranges for DUT NFs of 5, 10, and 15 dB

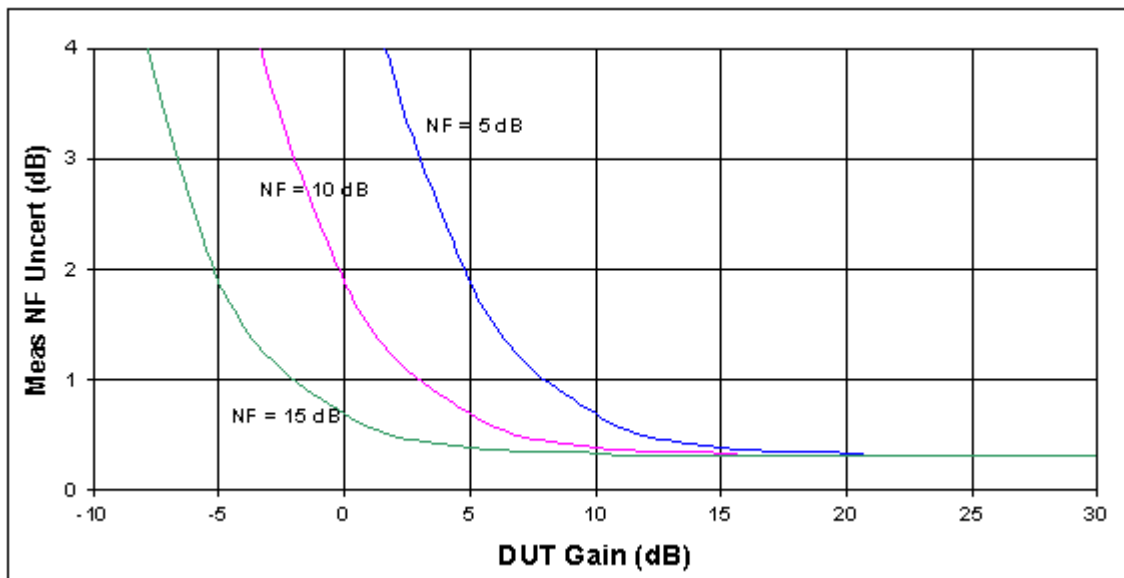

- Now suppose you have the same DUT with NF = ~7.5 dB and gain = 20 dB. Plotting these values on the curves will give you an estimated error that is ~0.4 dB, so the ESA can be used for this measurement.
- Suppose you measure a different DUT that has no gain and has NF = 10 dB. Plotting these DUT values on the above curves gives about 2 dB measurement error. So this second DUT's measurement results could be considered to have an unacceptable measurement

error.

Figure 8-3 No Preamp - Nominal Noise Figure¹

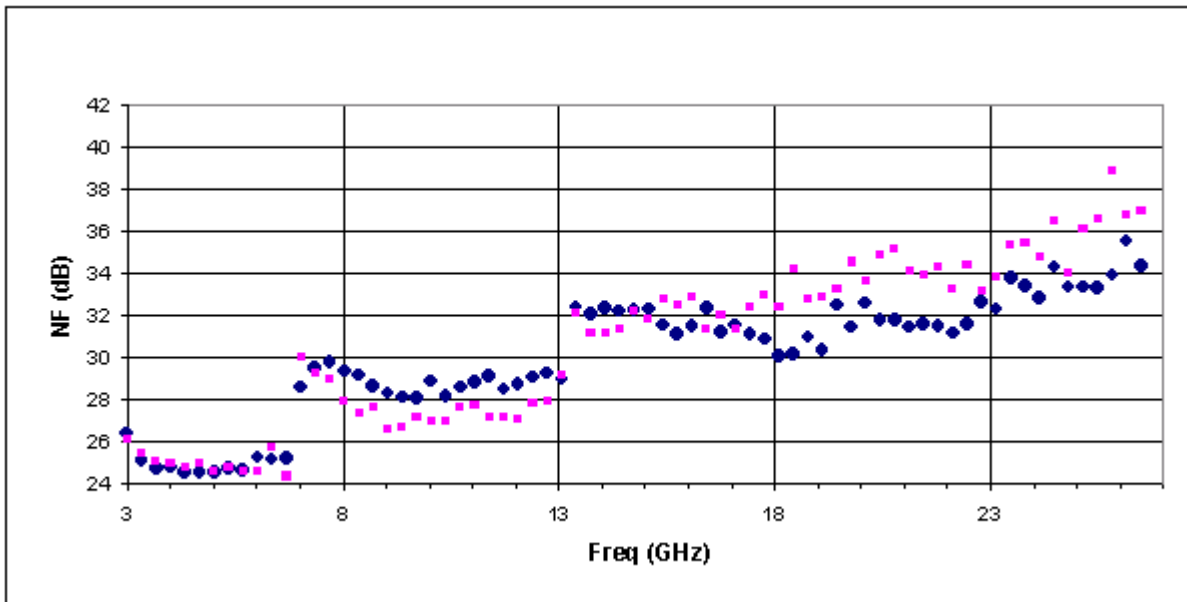

1. Graph shows measurements made with two sample analyzers

9 Contacting Agilent Technologies

Contacting Agilent

By internet, phone, or fax, get assistance with all your test and measurement needs.

Online assistance: www.agilent.com/find/assist

United States
(tel) 1 800 452 4844

Latin America
(tel) (305) 269 7500
(fax) (305) 269 7599

Canada
(tel) 1 877 894 4414
(fax) (905) 282-6495

Europe
(tel) (+31) 20 547 2323
(fax) (+31) 20 547 2390

New Zealand
(tel) 0 800 738 378
(fax) (+64) 4 495 8950

Japan
(tel) (+81) 426 56 7832
(fax) (+81) 426 56 7840

Australia
(tel) 1 800 629 485
(fax) (+61) 3 9210 5947

Asia Call Center Numbers

Country	Phone Number	Fax Number
Singapore	1-800-375-8100	(65) 836-0252
Malaysia	1-800-828-848	1-800-801664
Philippines	(632) 8426802 1-800-16510170 (PLDT Subscriber Only)	(632) 8426809 1-800-16510288 (PLDT Subscriber Only)
Thailand	(088) 226-008 (outside Bangkok) (662) 661-3999 (within Bangkok)	(66) 1-661-3714
Hong Kong	800-930-871	(852) 2506 9233
Taiwan	0800-047-866	(886) 2 25456723
People's Republic of China	800-810-0189 (preferred) 10800-650-0021	10800-650-0121
India	1-600-11-2929	000-800-650-1101

Numerics

- 119
 - option, 25
 - 1DS
 - option, 25
 - 219
 - option, 26
 - 346A noise source, 251
 - 346B noise source, 251
 - 346C noise source, 251
 - 8970B mode comparison, 124
 - 8970B modes, 124
- ## A
- ac input coupling, 273
 - accuracy
 - above 3 GHz, 352
 - greater, 25
 - adjustment
 - preselector, 212
 - after DUT loss compensation
 - noise figure, 327, 328
 - Agilent Technologies URL, 2, 86
 - amplitude
 - delta trace, 345
 - trace, 344
 - trace delta, 345
 - trace maximum, 343
 - trace minimum, 344
 - AMPLITUDE Y Scale
 - Attenuation, 197
 - Auto Scale, 197
 - front-panel key, 197
 - menu, 163, 164
 - Optimize Ref Level, 198
 - Ref Position, 197
 - Ref Value, 197
 - Scale/Div, 197
 - analyzer
 - noise figure, 248
 - analyzer uncertainty
 - noise figure, 248
 - annotation, 255
 - display, 203
 - application notes, 86
 - noise figure, 86
 - applications, selecting, 274, 275
 - ASCII data format, 264
 - attenuation, 197, 338, 340
 - maximum microwave input, 272, 338
 - maximum RF input, 272, 340
 - minimum microwave input, 272
 - minimum RF input, 272
 - noise figure, 212

- RF input, 271
 - setting, 313, 314
- attenuation, noise figure, 212
- auto scale
 - AMPLITUDE Y Scale, 197
- auto sweep time, 234
- available options
 - ESA-E Series, 29
- average count
 - carrier frequency drift, 316
- average detection, 309
- average mode, 217
- average state
 - noise figure, 316
- averaging, 53
 - monitor band/channel, 306, 307
 - noise figure, 316
- avg mode key, 217
- avg number
 - Meas Setup, 217

B

- bad calibration data, 352
- bandwidth, 53
 - resolution BW, 308, 318
 - setting resolution BW, 297, 307, 317
 - setting video BW, 297, 308
 - video BW, 297, 308
 - video BW ratio, 298, 309
- before DUT loss compensation
 - noise figure, 329, 330
- binary data order, 264
- blank
 - View/Trace, 235
- BW/Avg
 - front-panel key, 199
 - menu map, 165, 166
 - Res BW, 199
 - Auto, 199
 - Manual, 199
 - VBW/RBW, 200
 - Video BW, 199
- byte order of data, 264

C

- cal table
 - entering data, 58
 - SNS, 58
- CALCulate commands, 240
- calibrate, 319
- calibration, 56
 - input attenuation range, 60
 - maximum microwave attenuation, 272
 - maximum microwave attenuation input, 338

- maximum RF attenuation, 272, 340
- microwave attenuation, 271
- minimum microwave attenuation, 272
- minimum RF attenuation input, 272
 - performing calibration, 58
 - reasons for calibration, 57
 - RF attenuation input, 271
- calibration data is bad, 352
- calibration table
 - data, 320, 322
 - ID, 321
 - noise figure, 320, 322
 - serial number, 321
- carrier frequency drift
 - average count, 316
- center freq menu key, 207
- center frequency setting, 309, 334
- changing
 - instrument settings, 296
- choose option key, 30
- clear write
 - View/Trace, 235
- cold power, 285
- cold temperature, 288
- combined
 - View/Trace, 235
- combined graph display, 258
- commands
 - CALCulate, 240
 - CONFigure, 277
 - DISPlay, 253
 - FETCH, 278
 - FORMat, 264
 - INITiate, 278
 - INPut, 271
 - INSTRument, 274
 - MEASure, 277
 - MMEMory, 290
 - OUTPut, 294
 - READ, 279
 - SENSe, 296
 - SOURce, 341
 - TRACe, 343
- compatibility, 25
- compensation
 - loss after DUT, 327, 328
 - loss before DUT, 329, 330
- configure
 - downconverter, 299
 - DUT amplifier mode, 300
 - frequency downconverter, 299
 - frequency upconverter, 303

- IF frequency downconverter, 300
- IF frequency upconverter, 304
- local oscillator, 300, 302, 304
- mode IF frequency
 - downconverter, 299, 301, 303
 - mode system downconverter, 301
- oscillator, 302
- system, 302
- upconverter, 303
- CONFigure command use, 276
- CONFigure commands, 277
- configuring
 - frequency converter measurements, 111
 - loss compensation
 - fixed value, 94
 - table value, 97
 - temperature loss, 101
- connecting
 - for extended measurements, 127
- continuous
 - Peak Search, 215
- continuous measurement, 234
- continuous sweep, 234
- continuous vs. single
 - measurement mode, 267
- control measurement commands, 267
- copying option 219 to memory, 26, 28
- corrected data
 - display, 256
- correction
 - enter after DUT temperature, 333
 - enter before DUT temperature, 333
 - enter T cold temperature, 332
 - enter Tcold temperature, 332
 - setting ENR spot mode, 331
 - SNS T cold temperature, 331
- count
 - frequency list, 336
- coupling
 - ac/dc, 273
- creating
 - frequency list, 49
 - limit line, 91
- current measurement, 252
- D**
- data format, 264
- data from measurements, 276
- data security, 33
- date display, 255
- dc input coupling, 273
- default settings
 - restoring, 217, 225
- default values, setting remotely, 277
- defaults, 305
- delta
 - marker, 74, 213
- delta pair markers, 74, 213
- demodulation functions, 201
- Det/Demod
 - Detector
 - Auto, 201
 - Average, 201
 - Negative Peak, 202
 - Peak, 201
 - Sample, 201
 - front-panel key, 201
- Det/Demod menu map, 168
- detection type, 309
- detector key, 201
- diagram
 - DUT setup
 - Mode Setup, 227
- Disable All Limits menu key, 206
- disk drive commands, 290
- Display, 203
 - annotation, 203
 - display line, 203
 - edit., 203
 - front-panel key, 203
 - full Screen, 203
 - graticule, 203
 - menu, 203
 - preferences, 203
- display
 - annotation, 255
 - combined graph, 258
 - combining graph, 67
 - corrected data, 256
 - date, 255
 - display reference, 71
 - format, 63, 258
 - full screen, 64
 - graph view, 258
 - graticule, 68, 69
 - graticule lines, 258
 - limits, 203
 - markers, 72
 - reference position, 261
 - reference value, 260
 - result type, 65
 - scaling, 70
 - single graph, 66
 - trace data, 256, 257
- DISPlay commands, 253
- display commands, 253
- display line
 - display, 203
 - reference level, 254
 - scale/div, 254, 259
 - setting, 253
 - state, 254
- Display menu map, 169, 170
- displaying results, 63
- downconverter
 - frequency representation, 299
 - IF frequency, 299, 301, 303
 - offset, 300
- Downconverter description, 136
- downconverter system, 301
- Downconverting
 - Variable IF Fixed LO, 115
- DUT
 - amplifier configure mode, 300
 - correct after temperature, 333
 - correct before temperature, 333
 - DUT
 - Mode Setup, 226
 - Frequency-Downconverting, 115
 - gain, 246
 - input match, 246
 - noise figure, 247
 - output match, 247
 - setup, 225, 226
- DUT types
 - Frequency-Upconverting, 118
 - overview, 113
- E**
- edit
 - Display, 203
- editor
 - limit line, 91
- ENR, 37, 39, 40
 - loading from SNS, 320, 322, 324
 - mode, 325
 - setting spot mode, 331
 - spot, 325
 - spot mode, 326
 - spot T hot, 326
 - spot value, 44
 - table, 325
 - uncertainty, 249
- ENR data
 - extract ENR from SNS, 58
 - fails to load from SNS, 39, 348
 - load from diskette, 39
 - load from SNS, 39
 - manual entry, 40
- ENR table

- calibrate, 37
- common, 37
- data entry, 38
- measurement, 37
- entering normal ENR data, 38
- equipment required, 25
- example
 - making a basic amplifier measurement, 80
- Excess Noise Ratio, 37, 39, 40
- ext LO freq
 - DUT Setup, 226
- F**
- Factory Preset key, 231
- FAQs, 348
- FETCh command use, 276
- FETCh commands, 278
- File Type menu map, 171, 172, 173
- files
 - ENR data, 290, 291
 - frequency list data, 290, 292
 - limit lines, 291
 - loss compensation data, 291, 292
- filter requirements, 136
- Find
 - Peak Search, 215
- fixed ENR, 44
- Fixed Freq menu key, 208
- Fixed value loss compensation, 94
- format, 63
 - display, 258
- FORMat commands, 264
- format, data, 264
- freq context
 - DUT setup
 - Mode Setup, 226
- Freq List menu key, 209
- freq mode
 - fixed, 48
 - list, 48
 - sweep, 48
- Freq Mode menu key, 208
- frequency
 - center, 309
 - center setting, 334
 - fixed setting, 334, 335
 - list count, 336
 - measurement mode, 336
 - offset, 310
 - span, 311, 312, 336
 - start, 312, 337
 - stop, 313, 337
- FREQUENCY Channel
 - front-panel key, 207
- FREQUENCY Channel menu
 - map, 174, 175
- frequency downconverter
 - offset, 300
 - representation, 299, 302
- Frequency Downconverting DUT, 115
- frequency list
 - creating, 49
 - using swept points, 50
 - using the fill, 50
- Frequency Restrictions, 156
- frequency span
 - full, 312
 - setting, 311
 - zero, 312
- frequency upconverter
 - offset, 304
 - representation, 303
- Frequency-Converting
 - description, 129
- front-panel key
 - AMPLITUDE Y Scale, 197
 - BW/Avg, 199
 - Det/Demod, 201
 - Display, 203
 - FREQUENCY Channel, 207
 - Input, 210
 - Input/Output, 210
 - Marker, 213
 - Meas Setup, 217
 - MEASURE, 223
 - MODE, 224
 - Mode Setup, 225, 226, 228
 - Peak Search, 215
 - Preset, 231
 - Source, 232
 - SPAN X Scale, 233
 - Sweep Menu, 234
 - Trace/View. See front panel key
 - View/Trace
- View/Trace
 - attenuation, noise figure, 212
- full screen, 64
 - display, 203
- Full Screen key, 253
- further information on noise figure, 86
- G**
- gain, 282
 - analyzer, 247
 - DUT, 246
 - instrument, 247
- gate
 - trigger level, 340
- graph
 - view display, 258
- View/Trace, 235
 - zoom window, 262
- graticule, 68, 69
 - display, 203
- graticule lines
 - display, 258
- H**
- hardware
 - requirements, 25
- hot power, 286, 287
- I**
- IF frequency downconverter, 299, 301, 303
 - offset, 300
- IF frequency upconverter
 - offset, 304
- INITiate commands, 278
- initiate measurement, 267, 268
- input
 - attenuation, 313, 314
 - attenuation range RF, 60
 - calibration, 60
 - configuration, 271
 - coupling, 273
 - maximum microwave
 - attenuation, 272
 - maximum RF attenuation, 272
 - microwave attenuation, 271
 - minimum microwave
 - attenuation, 272
 - minimum RF attenuation, 272
 - RF attenuation, 271
- INPut commands, 271
- Input front-panel key, 210
- input match
 - DUT, 246
- Input/Output
 - attenuation
 - noise figure, 212
 - attenuation, noise figure, 212
 - input/output, 212
- Input/Output front-panel key, 210
- Input/Output menu map, 176, 177
- installing
 - ESA-E Series, 28
 - license key, 30
 - option 219, 26
- instrument
 - configuration, 274
 - gain, 247
 - match, 248
 - noise figure, 248
 - noise figure uncertainty, 248
 - saving state, 32

- INSTRument commands, 274
- internal preamp, 314, 338
 - meas setup, 217
- interpolated corrected state, 56
- invalid result, 79

- K**
- key presses
 - Fixed IF Variable LO (System Downconvert), 121
 - Variable IF Fixed LO (Downconvert), 115
 - variable IF fixed LO (upconvert), 118

- L**
- license key, 26
 - installing, 30
- licensing option 219, 26
- limit line
 - editor, 91
 - line 1, 89
 - line 2, 89
 - line 3, 89
 - line 4, 89
 - lower, 243
 - points on line, 241
 - specifying points, 241
 - state, 242
 - storing, 291
 - test, 242
 - testing, 240
 - upper, 243
 - use of, 89
- limits
 - display, 203
- loading
 - ENR data from an SNS, 38
 - ENR data from file, 290
 - frequency list data to file, 290
 - limit lines from file, 291
 - loss compensation data from file, 291
- local oscillator
 - offset, 300, 302, 304
- loss compensation, 210
 - after DUT, 327, 328
 - before DUT, 329, 330
- loss compensation configuring, 94, 97
- loss compensation use, 94
- lower limit line, 243

- M**
- making measurements, 276
- manual sweep time, 234

- Marker, 213
- marker, 72
 - all off, 214
 - band pair, 243
 - delta, 213, 243
 - delta pair, 74, 213
 - mode, 243
 - normal, 213, 243
 - off, 213, 245
 - on, 245
 - search, 244
 - search type, 244
 - searching, 77
 - select marker, 213
 - selecting, 72
 - state, 245
 - states, 74
 - X position, 245
 - Y position, 246
- marker 1, 72
- marker 2, 72
- marker 3, 72
- marker 4, 72
- Marker front-panel key, 213
- Marker menu map, 179
- marker state
 - delta, 74
 - noise figure, 245
- mass storage commands, 290
- match
 - analyzer, 248
 - instrument, 248
- max hold
 - View/Trace, 235
- maximum amplitude
 - trace, 343
- Meas, 217
- Meas Setup
 - avg number, 217
 - internal preamp, 217
 - menu map, 180, 181
 - restore meas defaults, 217
- Meas Setup front-panel key, 217
- Measure
 - Monitor Spectrum, 223
- measure, 223
 - noise figure, 223
- MEASure command use, 276
- MEASure commands, 277
- MEASURE front-panel key, 223
- MEASURE menu map, 178, 182
- measurement, 223
 - DUT type, 300
 - frequency mode, 336
 - points, 234
 - query current, 252
 - sweep, 80
- measurement modes
 - 8970B comparison, 124
 - NFA comparison, 124
 - selecting, 274, 275
- measurement table, 323
 - data, 324
 - ID, 323
 - serial number, 323
- measurement uncertainty, 106
- measurements
 - CONF/FETC/MEAS/READ commands, 276
 - control of, 267
 - getting results, 276
 - monitor band/channel, 306
 - monitor spectrum, 280
 - noise figure, 281, 282, 283, 284, 285, 286, 287, 288, 289, 316
 - setting default values remotely, 277
 - single/continuous, 267
- memory commands, 290
- memory requirements, ESA, 28, 29
- menu map
 - Amplitude Y Scale, 163, 164
 - BW/Avg, 165, 166
 - Det/Demod, 168
 - Display, 169, 170
 - File Type, 171, 172, 173
 - FREQUENCY Channel, 174, 175
 - Input/Output, 176, 177
 - Marker, 179
 - Meas Setup, 180, 181
 - MEASURE, 178, 182
 - Mode Setup, 184, 185
 - Model, 183
 - MonitorSpectrum, 167
 - Source, 186
 - SPAN X Scale, 187, 188
 - Sweep, 189, 190
 - Trace/View, 191, 192
 - Uncertainty Contributions, 193
 - View/Trace
 - see menu map
 - Trace/View
- meter
 - View/Trace, 235
- methods of normal ENR data
 - entry, 38
- microwave
 - input attenuation
 - microwave input, 271
 - maximum input attenuation, 272, 338

- minimum input attenuation, 272
 - microwave attenuation, 338
 - min hold
 - View/Trace, 235
 - minimum amplitude
 - trace, 344
 - MMEMory commands, 290
 - mode
 - fixed frequency, 52
 - noise figure, 224
 - spectrum analysis, 224
 - MODE front-panel key, 224
 - Mode menu map, 183
 - Mode Preset key, 231
 - Mode Setup
 - DUT Setup, 226
 - freq context, 226
 - Sideband, 226
 - System Downconverter, 226
 - DUT setup, 225, 226
 - diagram, 227
 - ext LO freq, 226
 - properties, 225
 - restore Mode Setup defaults, 225
 - Uncertainty Calculator, 228
 - uncertainty calculator, 225
 - view calculations, 228
 - view calculator, 228
 - Mode Setup front-panel key, 225, 226, 228
 - Mode Setup menu map, 184, 185
 - monitor
 - sweep time, 315
 - trace points, 315
 - monitor band/channel
 - average count, 306
 - averaging state, 306
 - measurement, 306
 - monitor band/channel - averaging
 - termination control, 307
 - Monitor Spectrum
 - Measure, 223
 - monitor spectrum measurement, 280
- N**
- negative peak detection, 309
 - NFA mode comparison, 124
 - NFA modes, 124
 - noise factor, 283
 - noise figure, 284, 319
 - after DUT loss compensation, 327, 328
 - analyzer, 248
 - analyzer uncertainty, 248
 - average state, 316
 - averaging termination control, 316
 - before DUT loss compensation, 329, 330
 - calibration, 319
 - calibration table, 320
 - data, 320
 - calibration table data, 320, 322
 - calibration table ID, 321
 - calibration table serial number, 321
 - cold power, 285
 - cold temp., 288
 - corrections, 210, 256
 - DUT, 247
 - DUT gain, 246
 - DUT input match, 246
 - DUT output match, 247
 - ENR mode, 325
 - ENR spot mode, 326
 - ENR spot T hot, 326
 - ENR uncertainty, 249
 - further information, 86
 - gain, 282
 - hot power, 286, 287
 - instrument, 248
 - instrument gain, 247
 - instrument match, 248
 - instrument uncertainty, 248
 - limit line
 - display, 242
 - type, 243
 - limit line data, 241
 - limit line state, 242
 - limit line test, 242
 - limit lines, 241
 - marker band pair, 243
 - marker mode, 243
 - marker search, 244
 - marker search type, 244
 - marker state, 245
 - marker X position, 245
 - marker Y position, 246
 - measure, 223
 - measurement, 281, 316
 - measurement table data, 324
 - measurement table ID, 323
 - measurement table serial
 - number, 323
 - mode, 224
 - noise factor, 283
 - RSS uncertainty, 249
 - source ENR uncertainty, 249
 - source match, 250
 - source type, 251
 - uncertainty, 106
- Y factor, 289**
- noise figure measurement
 - noise figure, 284
 - noise figure measurement table, 323
 - noise figure measurements
 - further information, 86
 - noise source, 232
 - model number, 41
 - normal, 37
 - on/off, 294
 - serial number, 41
 - smart, 37
 - noise source selection
 - normal or sns, 341
 - on or off, 341
 - normal
 - marker, 213
 - noise source selection, 341
 - normal noise source, 37
- O**
- offset frequency setting, 310
 - optimize ref level
 - AMPLITUDE Y Scale, 198
 - option
 - 119, 25
 - 1DS, 25
 - 219, 26
 - available, 29
 - oscillator
 - offset, 300, 302, 304
 - OUTPut commands, 294
 - output match
 - DUT, 247
 - outputs, configuration commands, 294
 - overview
 - DUT types, 113
 - frequency converter
 - measurements, 111
- P**
- pass/fail test, 240
 - pause
 - measurement, 269
 - restart, 270
 - Pcold, 285
 - Peak, 215
 - Peak Search
 - continuous, 215
 - Find, 215
 - search type, 215
 - select marker, 215
 - Peak Search front-panel key, 215
 - peak to peak
 - trace, 346

- personalities
 - selecting, 274, 275
- Phot, 286
- points
 - in sweep, 338
 - menu key, 209
 - sweep, 234
- positive peak detection, 309
- power cycle, 32
- preamp
 - internal, 314, 338
- preferences
 - display, 203
- presel adjust, 212
- preselector adjustment, 212
- preset, 32
 - factory, 32, 231
 - mode, 231
 - user, 32, 231
- Preset front-panel key, 231
- problems with measurement, 348
- properties
 - Mode Setup, 225
- R**
- READ command use, 276
- READ commands, 279
- real number data format, 264
- ref level, 71
- Ref Position
 - AMPLITUDE Y Scale, 197
- Ref Value
 - AMPLITUDE Y Scale, 197
- reference position
 - display, 261
- reference value
 - display, 260
- requirements
 - hardware, 25
- Res BW
 - BW/Avg, 199
- Res BW key, 199, 200
- resolution bandwidth, 199, 200
 - adjusting, 199, 200
 - auto man, 199
 - on/off, 308, 318
 - setting, 297, 307, 317
- restart measurement, 270
- restore meas defaults
 - Meas Setup, 217
- restore Mode Setup defaults
 - Mode Setup, 225
- restricted terms, 156
- result A
 - View/Trace, 235
- result B
 - View/Trace, 236
- result invalid, 79
- result type, 65
- results displaying, 63
- resume measurement, 270
- RF
 - input attenuation, 271
 - maximum input attenuation, 272, 340
 - minimum input attenuation, 272
- RF attenuation, 340
- RF input attenuation range, 60
- RMS detection, 309
- RSS uncertainty
 - noise figure, 249
- S**
- sample detection, 309
- saving
 - ENR table data, 43
 - instrument state, 32
 - limit lines, 291
 - setup settings, 32
 - state settings, 32
 - traces, 292
- saving instrument state, 32
- saving traces, 293
- scale/div
 - AMPLITUDE Y Scale, 197
 - display line, 259
- scaling, 70
- search type
 - Peak Search, 215
- searching markers, 77
- security, 33
- select marker, 213
 - Peak Search, 215
- selecting
 - averaging, 55
 - bandwidth, 53
 - fixed freq, 52
 - freq list, 49
 - freq sweep, 48
 - markers, 72
- SENSe commands, 296
- SENSe defaults, 305
- setting
 - avg mode, 217
 - limit lines, 89
 - microwave input attenuation, 62
 - RF input attenuation, 62
 - T cold, 46
 - T hot, 45
- setup
 - saving, 32
- Sideband
 - DUT Setup
 - Mode Setup, 226
 - Single measurement, 234
 - single sideband (SSB), 135
 - Single Sweep, 234
 - single vs. continuous
 - measurement mode, 267
 - smart noise source, 25
 - loading ENR data, 320, 322, 324
 - Smart Noise Source (SNS), 37
 - SNS, 25, 37
 - ENR data fails to load, 39, 348
 - load ENR data, 39
 - loading ENR data, 320, 322, 324
 - noise source selection, 341
 - T cold, 47
 - T cold fails to load, 39, 348
 - source
 - menu map, 186
 - noise source, 232
 - SOURce commands, 341
 - source ENR uncertainty
 - noise figure, 249
 - Source front-panel key, 232
 - source match
 - noise figure, 250
 - source type
 - noise figure, 251
 - span, 336
 - Span key
 - start offset, 233
 - stop offset, 233
 - span setting, 311, 312
 - SPAN X Scale
 - menu map, 187, 188
 - SPAN X Scale front-panel key, 233
 - spectrum analysis mode, 224
 - spectrum, monitor
 - Measure, 223
 - spot ENR, 44
 - spot T hot, 45
 - start, 337
 - Start Freq menu key, 207
 - start frequency, 312
 - start measurement, 267, 268, 270
 - starting
 - noise figure measurements, 31
 - option 219, 31
 - state
 - changing, 296
 - saving, 32
 - stop, 337
 - Stop Freq menu key, 208
 - stop frequency, 313

- storing
 - ENR data to file, 291
 - frequency list data to file, 292
 - limit lines, 291
 - limit lines from file, 291
 - loss compensation data to file, 292
 - traces, 292, 293
- Sweep, 234
 - continuous, 234
 - menu map, 189, 190
 - points, 234
 - Single, 234
- Sweep Menu front-panel key, 234
- sweep points, 338
- Sweep Time, 234
 - manual, 234
- sweep time
 - auto, 234
 - monitor, 315
- system
 - frequency representation, 302
 - offset, 302
- System Downconverter
 - DUT Setup Mode Setup, 226
- System Downconverter
 - description, 149
- System Downconverter, 121
 - Fixed IF Variable LO, 121
- T**
- T cold, 288
 - changing data, 46, 47
 - fails to load from SNS, 39, 348
 - setting, 46
 - taken from SNS, 47
 - temperature correction, 331, 332
 - user defined from SNS, 331
- T hot, 287
 - noise figure, 326
- T hot spot value, 45
- table
 - View/Trace, 235
- table value loss compensation, 97
- Tcold
 - temperature correction, 332
- temperature
 - cold, 288
 - configuring loss, 101
 - correction, 46, 47
 - enter after DUT correction, 333
 - enter before DUT correction, 333
 - enter T cold correction, 332
 - enter Tcold correction, 332
 - SNS T cold correction, 331
- temperature correction, 46
- test limits, 240
- time display, 255
- trace
 - amplitude, 344
 - amplitude delta, 345
 - display data, 256, 257
 - minimum amplitude, 343, 344
 - peak to peak, 346
 - storing, 292
 - View/Trace, 235
- TRACe commands, 343
- trace format, 264
- trace points
 - monitor, sweep
 - trace points, 315
- Trace/View
 - see View/Trace
 - view, 235
- traces
 - storing, 293
- trigger
 - level, gate, 340
- trigger measurement, 267, 268
- troubleshooting, 348
- U**
- unauthorized access
 - preventing, 33
- uncertainties above 3 GHz, 352
- uncertainty
 - noise figure, 248
- uncertainty calculator, 106
 - Mode Setup, 225
 - mode setup, 228
- uncertainty contributions
 - menu map, 193
- uncorrected state, 56
- upconverter
 - frequency representation, 303
 - offset, 304
- upconverter description, 136
- upconverting
 - variable IF fixed LO, 118
- upper limit line, 243
- URL (Agilent Technologies), 2
- user preset key, 231
- V**
- VBW/RBW
 - BW/Avg, 200
- video bandwidth, 199
 - adjusting, 199
 - BW/Avg, 199
 - on/off, 297, 308
 - setting, 297, 308
- video bandwidth, adjusting, 200
- Video BW, 200
- Video BW key, 200
- video BW key, 199
- video/resolution bandwidth ratio, 298, 309
- view
 - Trace/View, 235
- view calculations
 - uncertainty calculator
 - Mode Setup, 228
- view calculator
 - uncertainty calculator, 228
- view commands, 253
- View/Trace
 - blank, 235
 - clear write, 235
 - combined, 235
 - front-panel key
 - graph, 235
 - max hold, 235
 - menu map, 191, 192
 - meter, 235
 - min hold, 235
 - result A, 235
 - result B, 236
 - table, 235
 - trace, 235
- Y**
- Y factor, 289
- Z**
- zero span, 312
- zoom graph window, 262

